

Determination of Trace Anions in Concentrated Glycolic Acid

INTRODUCTION

There is a need for a reliable method to determine trace chloride and sulfate in glycolic acid. The presence of these ions in glycolic acid that is used for soldering fluxes can corrode electronic parts.¹ Determination of these ions is hampered by the large excess of glycolate ion. Diluting the concentrated sample reduces the concentration of the interfering matrix ion but results in a lack of sensitivity for the contaminant ions of interest. An improved method for determining trace anions in concentrated weak acids has been developed to overcome this problem.^{2,3} Trace inorganic anions of strong acids are separated from the high concentration of glycolate by an ion exclusion separation prior to an ion exchange separation.

This Technical Note describes the theory, set up, and analytical procedure for the determination of trace chloride and sulfate at sub-mg/L (ppm) levels in 0.7-17.5% (v/v) glycolic acid.

SUMMARY OF THE METHOD

An IonPac[®] ICE-AS6 ion exclusion column is used on-line for sample pretreatment to separate the analyte ions from an excess of glycolate matrix ions. A selected fraction from the ion exclusion separation is “cut” and sent to a 4-mm IonPac AG9-HC anion exchange concentrator column. The concentrated ions are then eluted onto a 2-mm IonPac AS9-HC column set where the anions of interest are separated and detected by suppressed conductivity.

EQUIPMENT

DX-500 Ion Chromatography System consisting of:

GP50 Gradient pump, microbore configuration

CD20 Conductivity detector with a temperature controlled conductivity cell (DS3)

LC20 Enclosure, 2 Rheodyne valves, PEEK, rear loading

Dionex RP-1 single piston pump

Pressurizable Reservoir Chamber (P/N 37053)

AC2 Power Control Accessory

CAM (Controlled Air Module)

Low Pressure 4-Way Valve, 10-32 fittings (P/N 45010)

(3) Plastic bottle assemblies, 4 L, 2 for external water, (1) for rinse solution (P/N 39164)

(1) O-ring, Teflon encapsulated, for rinse solution bottle (P/N 43523)

(2) O-ring, Teflon encapsulated, for Reservoir Chamber (P/N 55703)

(1) Air pressure gauge 0 to 171 kPa (0-25 psi) (for external water)

305 cm (66 in.) of green 0.75 mm (0.030 in.) PEEK tubing to connect columns and make a 750-mL sample loop

High-density polyethylene bottles as sample containers

PeakNet Chromatography Workstation

Columns

IonPac AG9-HC guard column, 2 mm (P/N 052248)
IonPac AS9-HC analytical column, 2 mm (P/N 052244)
IonPac AG9-HC concentrator column, 4 mm (P/N 051791)
IonPac AG10 as trap column, 4 mm (P/N 043119)
IonPac ICE-AS6 analytical column, 9 x 250 mm
(P/N 079798)
Anion Self Regenerating Suppressor® (ASRS®-ULTRA),
2 mm (P/N 53947)

REAGENTS AND STANDARDS

Deionized water (DI H₂O) Type I reagent grade,
17.8 MΩ-cm resistance or better
Sodium hydroxide 50% (w/w) aqueous solution
(Fisher Scientific)
0.5 M Carbonate Anion Eluent Concentrate
(Dionex P/N 37162)
Chloride standard 1000 mg/L, 100 mL
(Dionex P/N 37159)
Sulfate standard 1000 mg/L, 100 mL (Dionex P/N 37160)

CONDITIONS

Ion Exclusion

Analytical Column: IonPac ICE-AS6
Trap column: IonPac AG10, 4 mm
Eluent: Deionized water
Flow rate: 0.55 mL/min

Ion Chromatography

Analytical column: IonPac AS9-HC, 2 mm
Guard column: IonPac AG9-HC, 2 mm
Concentrator column: IonPac AG9-HC, 4 mm
Eluent: 8 mM Sodium carbonate
1.5 mM Sodium hydroxide
Flow rate: 0.25 mL/min
Sample volume: 750 µL
Detection: Suppressed conductivity, ASRS,
AutoSuppression® external water
mode
Suppressor
current setting: 100 mA
Expected system
Backpressure: 13.8 MPa (2000 psi) (with concen-
trator column in line)

Expected
Background
Conductivity: 20 µS

PREPARATION OF SOLUTIONS AND REAGENTS

Eluent Solutions

8.0 mM Sodium Carbonate / 1.5 mM Sodium Hydroxide

Add 16.80 g of 0.5 M sodium carbonate and 0.12 g of 50% sodium hydroxide directly to 900 g degassed, deionized water (having a specific resistance of 17.8 MΩ-cm or greater) in an eluent bottle. Dilute to 1,000 g and vacuum degas for 5 min.

200 mM Sodium Hydroxide (AG10 trap column regeneration) preparation:

Dilute 16.00 g of 50% (w/w) sodium hydroxide with degassed, deionized water (having a specific resistance of 17.8 MΩ-cm or greater) to a final weight of 1000 g in an eluent bottle. Avoid the introduction of carbon dioxide from the air into the aliquot of 50% (w/w) sodium hydroxide and the deionized water being used to make the eluent.

Standard Solutions

Stock standard solution (1000 mg/L)

Use Dionex 1000 mg/L ion standard solution or equivalent.

Working standard solution (1.00 mg/L)

To prepare a mixed working standard solution, combine 1.00 mL of each 1000 mg/L anion stock solution with deionized water and dilute to a final volume of 1000 mL.

Sample Preparation

This method can accommodate glycolic acid at dilutions of 0.7% to 17.5% (v/v). Select an appropriate dilution based on the expected concentration of the analytes of interest. To prepare 0.7% (v/v) glycolic acid begin by pouring 90 mL of deionized water into a clean 100-mL volumetric flask. While in a fume hood, very slowly and carefully add 1.00 mL (1.27 g) of 70% concentrated glycolic acid to the deionized water. Gently mix the acid with the water. Always add acid to water not water to acid. Add deionized water to a final volume of 100 mL.

CALIBRATION

Dilute each sample with deionized water to bring the analyte response within a reasonable range (<100 μ S). Prepare calibration standards at a minimum of three concentration levels by diluting the working standard. Select a range similar to the expected concentrations in the samples. The method of standard additions (adding one or more increments of a standard solution to sample aliquots of the same size) should be used to minimize effect of the concentrated acid matrix on the measured conductivity of the analytes of interest.⁴ Calibration standards are added to the deionized water used to dilute the concentrated glycolic acid from 70% (w/w) to 0.7% (v/v). The following formula can be used to calculate concentrations in mg/L for dilutions:

$$\frac{(\text{Conc. of stock solution, mg/L}) (\text{Vol. of stock solution, mL})}{(\text{Conc. of dilute standard, mg/L}) (\text{Vol. of dilute standard, mL})} =$$

The procedure for preparing standards in 100 mL of 0.7% (v/v) glycolic acid is as follows:

1. Prepare a dilute mixed standard solution of 1000 μ g/L for chloride and sulfate.
2. Add aliquots of this standard solution to deionized water using the volumes in Table 1.
3. Carefully add 1.00 mL of 70% (w/w) glycolic acid to the 99 mL of dilute standard and deionized water.

IONPAC AG10 TRAP COLUMN PREPARATION

The AG10 trap column must first be regenerated. Monitoring the blank will indicate when regeneration is necessary. Typically, monthly regeneration is necessary, but it will depend upon the quality of the deionized water

Amount of Deionized Water (mL)	Amount of 1000 μ g/L Anion Stock (mL)	Anion Concentration (μ g/L)	Final Volume of 0.7 % (v/v) Glycolic acid (mL)
98	1.000	10	100
96	3.000	30	100
89	10.00	100	100
69	30.00	300	100

and usage rate of the instrument. Increased contamination in the water blank indicates that the AG10 requires regeneration. The procedure is as follows:

1. Pump 200 mM sodium hydroxide through the AG10 at 1.0 mL/min for 50 min.
2. Follow with a rinse of deionized water at the same flow rate for 20 min.

DISCUSSION OF THE METHOD

This method addresses the challenge of determining trace concentrations of contaminant ions such as chloride and sulfate in a matrix composed of a high concentration of glycolate ion. The method is accomplished in two steps: an ion exclusion (ICE) pre-separation followed by injecting a portion of the ICE separation to an ion chromatographic (IC) separation.

The ion exclusion mechanism separates ionized species from nonionized or weakly ionized species. This occurs because of a negatively charged hydration shell on the stationary phase surface called the Donnan membrane.⁵ Figure 1 illustrates the application of this ICE mechanism to the separation of trace anions from 0.7% (v/v) glycolic acid using an ICE-AS6 ion exclusion column. This chromatogram is a measurement only of the unsuppressed conductivity response for the ICE separation. The strong acid ions, such as chloride and sulfate, are excluded and elute as a small peak with a retention time of approximately 11 min. The weakly ionized glycolate matrix ions are retained and thus elute later as a large peak.

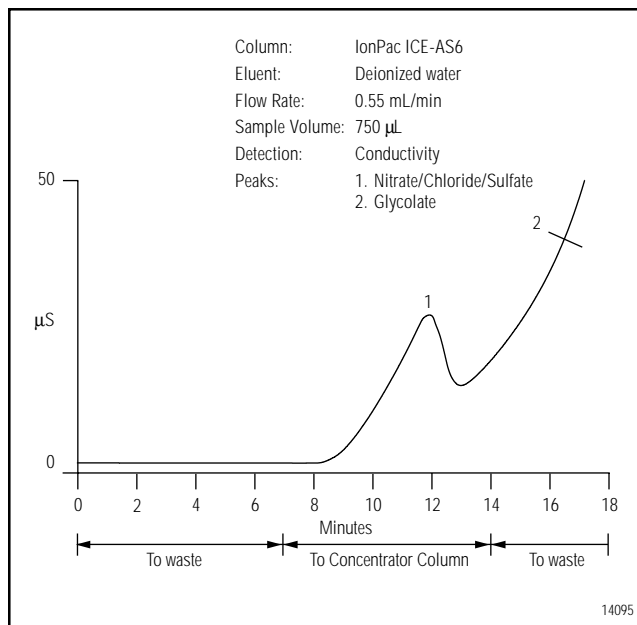
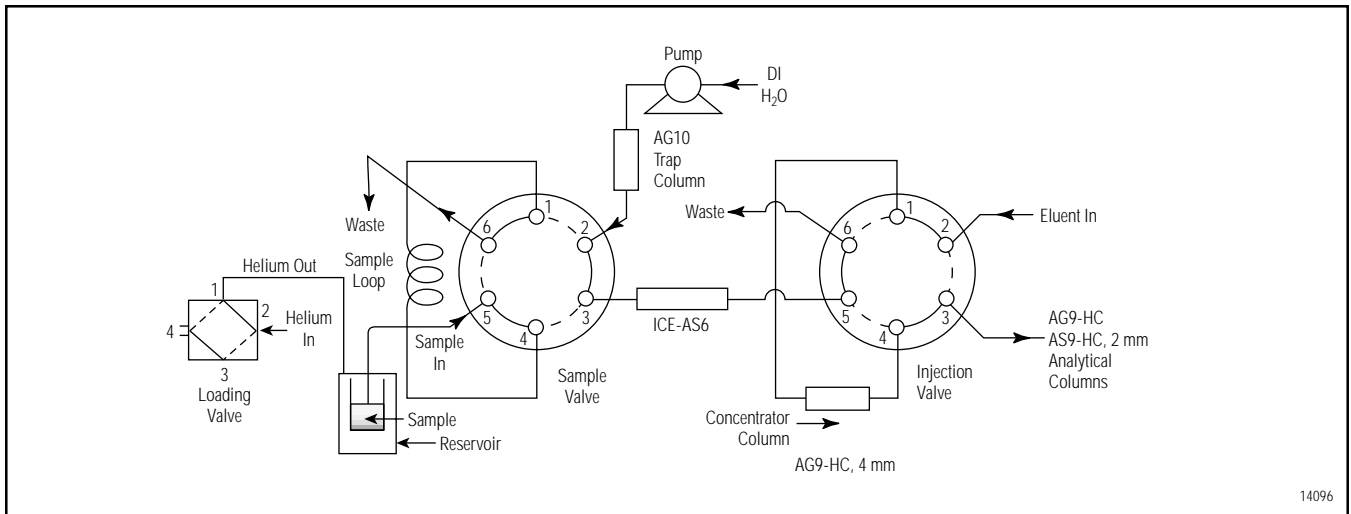
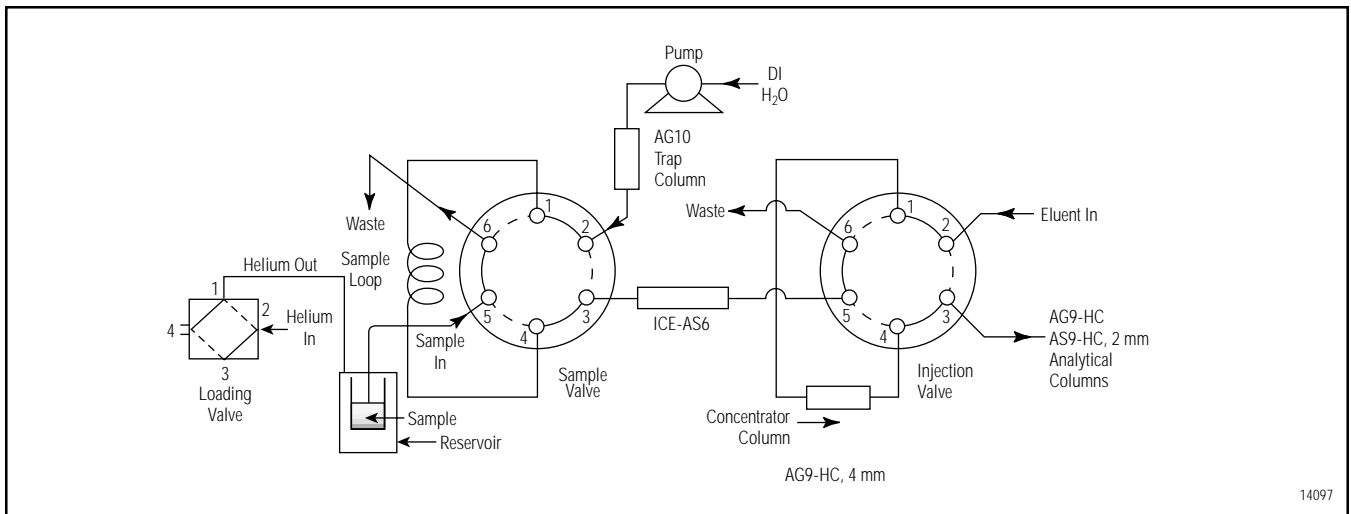

Figure 1. Ion exclusion separation for 0.7% glycolic acid.



14096

Figure 2. Loading the sample loop.



14097

Figure 3. First stage of the ICE separation (time 0.0–7.0 min).

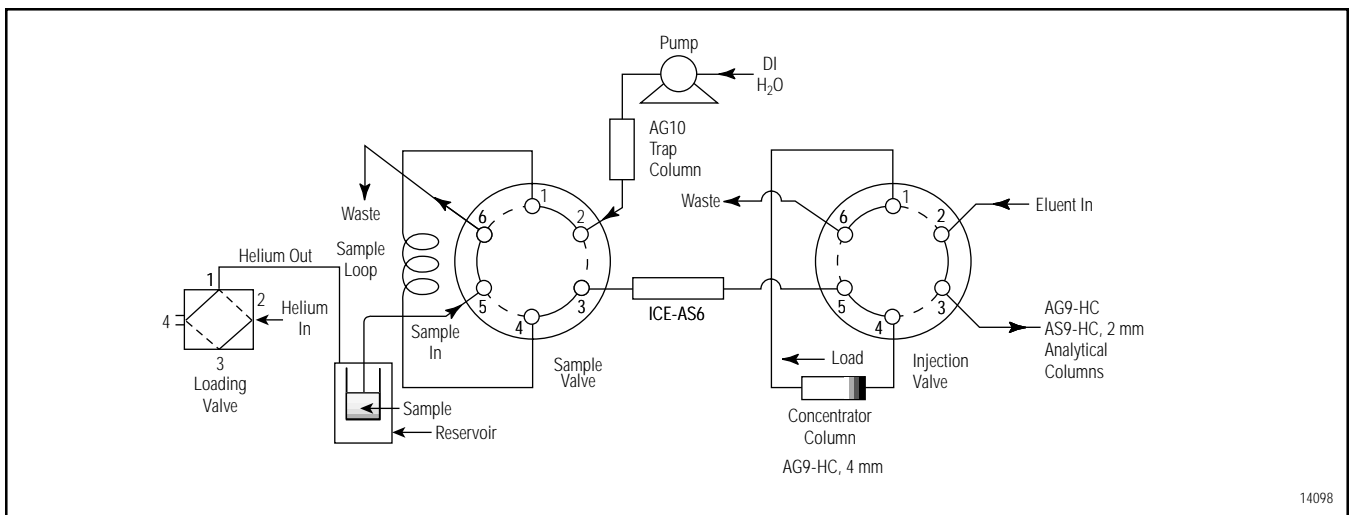

14098

Figure 4. Concentrating the "cut" portion (time 7.0–14.0 min).

4 Determination of Trace Anions in Glycolic Acid

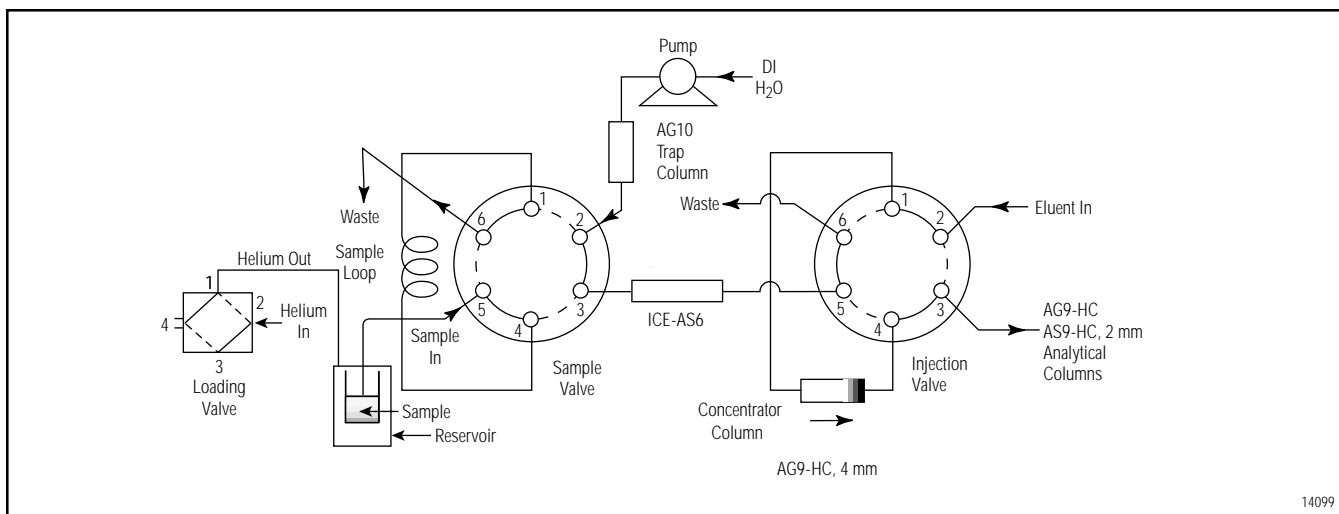

Figure 5. Separating the retained ions.

A series of schematics (Figures 2-5) illustrates the operation of the chromatographic hardware. The concentrated glycolic acid sample is loaded via a pressurized reservoir into the 750- μ L sample loop (Figure 2). Helium or nitrogen at 34.5 kPa (5 psi) is used to push sample from the sample container into the sample loop at a flow rate of \sim 1 mL/min (1.27 g/min). This technique ensures that a representative sample of the concentrated glycolic acid sample is loaded into the sample loop. It is important to pass at least four loop volumes through the sample loop to ensure reproducible sampling.⁶

The 0.7% glycolic acid in the sample loop is then delivered with a high purity water carrier stream to the IonPac ICE-AS6. An AG10 is placed after the RP-1 pump to act as an anion trap column for the deionized water. Any contaminants present in this water will impact the quality of the blank. The first portion of the ICE separation from 0.0 to 7.0 min is sent to waste (Figure 3). Then, the concentrator column is placed in-line with the ICE column and the portion from 7.0 to 14.0 min is captured on the concentrator column (Figure 4). After 14.0 min the ICE column is taken out of line and the 4-mm AG9-HC concentrator column is placed in-line with the 2-mm AS9-HC analytical column set and the concentrated ions are separated (Figure 5). This time window should ensure the preconcentration of all the chloride and sulfate with a minimal amount of glycolate.

The IC separation uses an AS9-HC with an isocratic eluent of 8 mM sodium carbonate 1.5 mM sodium hydroxide. The high capacity of the AS9-HC column allows injection of these relatively concentrated samples without overloading. Figure 6 shows a separation of the

common anions in deionized water with the 2-mm IonPac AS9-HC under standard conditions. These chromatographic conditions enable the separation of chloride from glycolate as well as carbonate.

A 2-mm microbore column analytical column set was chosen because it has a four-fold increase in mass sensitivity over the standard bore column. This facilitates faster loop loading because smaller sample volumes are required. The microbore format also offers low eluent consumption and less waste generation. An IonPac AG9-HC ion exchange column was used as the concentrator column in the 50 x 4 mm format instead of 50 x 2 mm because the 4-mm column had four times more capacity than the 2-mm column and lower back pressure at the microbore flow rate. No significant degradation in separation efficiency was observed when coupling a 4-mm concentrator column with a 2-mm analytical column set.

During the IC separation, the deionized water rinses the ICE-AS6 and associated tubing to ensure that there is no contamination from the previous sample. To prevent sample depletion, at 2.90 min the PeakNet method stops the flow of helium pressure to the reagent reservoir after enough sample has been loaded.

SYSTEM PREPARATION AND TEST

Refer to the system configuration schematics in Figures 2-5 and Table 2 that summarize the types and lengths of tubing required for system configuration. The chromatographic hardware is divided into two parts: the ion exclusion pretreatment portion with the ICE-AS6 and the IC analysis portion with the AS9-HC.

IC system

1. Prepare the ASRS by following the Quickstart instructions (Dionex Document 031368-02) included with the Instructions and Troubleshooting Guide for the ASRS.
2. Install the 2-mm AG9-HC and AS9-HC by using the red 0.125-mm (0.005 in.) tubing. To minimize dead volume, use the smallest possible lengths of tubing and ensure that the ends of the tubing are smooth and level.
3. Construct a 5- μ L sample loop by cutting a 9.9-cm (3.9 in.) portion of the black 0.25-mm (0.010 in.) PEEK tubing.
4. Install this sample loop between ports 1 and 4 of the injection valve in the IC analysis system.
5. Install the ASRS and configure it in the external water mode as described in the SRS manual.
6. Establish eluent flow through the 2-mm AG9-HC and AS9-HC analytical column set. The expected background conductivity is ~ 20 μ S. (Note: for trace analysis it will take at least five hours for the system to achieve stable background conductivity.)
7. Verify proper operation of the IC portion of the system by injecting a low level-ppm standard to replicate the column test chromatogram.
8. Remove the 5 μ L sample loop and install the 4-mm AG9-HC concentrator column. Make sure that the arrow indicating flow on the column is pointed from port 1 to port 4. Make the tubing length connecting the outlet of this column and port 4 is as short as possible.
9. Configure the IC valve so that the 4-mm AG9-HC concentrator column is in-line with the 2-mm AG9-HC and AS9-HC analytical column set. Check for leaks. The expected system back pressure for these three columns at 0.25 mL/min is ~ 13.8 MPa (2,000 psi).

Table 2 Details of Tubing Configuration for Trace Anions in Glycolic Acid

Connection Points	Tubing Description	Length (cm)	Remarks
ICE exit => Port 5	Green 0.030-in (0.75-mm)	30	
ICE input => Port 3	Green 0.030-in (0.75-mm)	70	
Port 1 => Port 4	Green 0.030-in (0.75-mm)	44	750 μ L sample loop
AG9-HC => Port 4	Red 0.005-in (0.125-mm)	3	Should be as short as possible
AG9-HC => Port 1	Black 0.010-in (0.25-mm)	25	
Port 3 => Analytical	Red 0.005-in (0.125-mm)	3	Should be as short as possible

Ion Exclusion Sample Pretreatment System

This section describes the preparation of the ICE portion of the system. It is important that the same type and length of tubing as described in Table 2 be used to successfully perform this analysis. Changes in tubing length will result in a different “cut” from the ICE-AS6 column being delivered to the AS9-HC concentrator column.

1. Cut a 165-cm (66 in.) portion of the 0.030-in. (0.75 mm) i.d. green PEEK tubing to make a 750- μ L sample loop and install this loop between port 1 and 4 of the sample valve.
2. Prepare the AG10 trap column according to the directions in the section entitled “IonPac AG10 Trap Column Regeneration”. (Caution: Before the AG10 is installed in the system it is important that the sodium hydroxide solution used for the storage or cleaning be completely rinsed away. The ICE-AS6 is not compatible with sodium hydroxide eluent.)
3. The entire pathway from the RP-1 pump to port 5 of the IC valve is plumbed with the green PEEK 0.75-mm (0.030 in.) tubing. Install the AG10 at the exit port of the RP-1 pump.
4. Install the ICE-AS6 column using a 70-cm piece of green PEEK tubing between the exit of the ICE-AS6 and port 5 of the injection valve. Use a 30-cm portion of green tubing between port 3 of the sample valve and the input of the ICE-AS6.

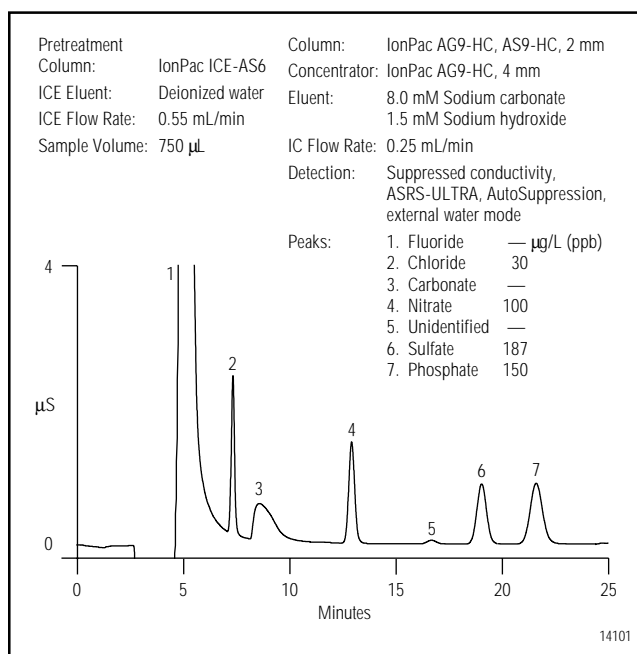

Figure 6. Trace anion standard in deionized water.

5. Check to see that there is about 34.5 kPa (5 psi) head pressure on the incoming deionized water that feeds the RP-1 pump.
6. Connect the exit port of the reagent reservoir to port 5 of the sample valve with 0.75-mm (0.030 in.) green tubing.
7. Configure a waste line from port 6 of the sample valve with the green PEEK tubing.
8. Connect the reagent reservoir to helium pressure of about 34.5 kPa (5 psi).
9. Begin with a container filled with deionized water as a sample to rinse the sample lines of any trace contamination.
10. Set a flow rate of 0.55 ± 0.02 mL/min for the RP-1 pump by adjusting the dial on the pump. This should be measured with the 4-mm AG9-HC concentrator column out of line. Measure the flow rate by collecting the waste coming out of port 6 of the IC valve. It is critical for the success of this method that this flow rate be consistent.
11. Pump deionized water at 0.55 mL/min through the ICE-AS6 to waste without the 4-mm AG9-HC in line for 1 h. This will remove the 0.4 mM heptafluorobutyric acid storage solution. It is typical with this method to detect trace amounts of sulfate in the deionized water blank.
12. The ICE-AS6 can be further conditioned by rinsing it with 100 mM glycolic acid for 2 h at 0.55 mL/min followed by a 1-h rinse with 17.8 M Ω -cm deionized water. This will reduce the sulfate blank to 50 μ g/L or less. Continue to monitor the blank, especially when starting up the system after it has been idle for more than two days.
13. Connect the wires between the GP50 and the AC2 according to the wiring diagram in Figure 7. This wiring scheme will ensure that in the event of a power outage, that the units will be in the OFF position when power is restored.
14. Plug the RP-1 pump into outlet 1 of the AC2 and the Controlled Air Module (CAM) into outlet 2.
15. Connect the color-coded air lines of the CAM (See Figure 7). The CAM directs 689 kPa (100 psi) air pressure to the slider valve to regulate the flow of 34.5 kPa (5 psi) helium to the reagent reservoir.
 - a. Red tubing to a source of air pressure.
 - b. Green tubing to the barbed fitting at the top of the slider valve (orientation groove marks the top of the valve).
 - c. Yellow tubing to the barbed fitting at the bottom of the slider valve.

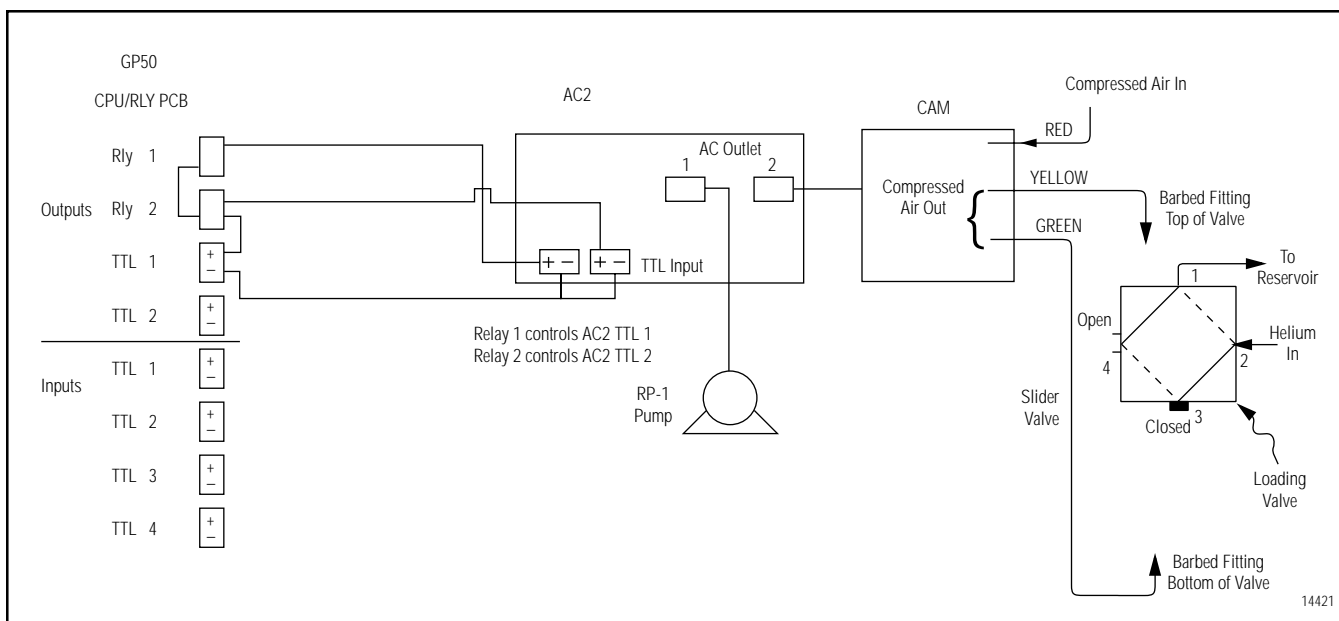

Figure 7. Wiring diagram for AC2 and CAM.

16. Configure the valve ports on the slider valve as follows:
 - a. Port 1 - Helium Out to the reagent reservoir
 - b. Port 2 - Helium In 5 psi (34.5 kPa)
 - c. Port 3 - Closed
 - d. Port 4 - Open
17. Confirm that, by actuating Relay 1, the RP-1 pump can be turned on and off. Likewise, confirm that by actuating Relay 2, the flow of helium to the reagent reservoir can be turned on and off.
18. To reduce the sulfate blank, continue pumping deionized water through the ICE-AS6 overnight.

System Operation

After all aspects of the instrumentation have been prepared, the system is ready for sample analysis.

1. Load the PeakNet method shown in Table 3.
2. Fill the 750- μ L sample loop with deionized water. Use helium gas pressure to push the deionized water sample using the reagent reservoir (Figure 2).
3. Analyze a blank by loading deionized water as the sample. It might take several runs until the system has been rinsed of contamination.
4. Dilute concentrated glycolic acid, 70% (w/w) to 0.7% (v/v) using the procedure described in the Sample Preparation section. *Caution: concentrated glycolic acid must be handled with care. Consult the applicable Material Safety Data Sheet (MSDS) for specific details about protective equipment, reactivity, storage, disposal, and health effects.*
5. The diluted 0.7% (v/v) glycolic acid can be loaded directly into the 750- μ L loop by the reagent delivery module as discussed earlier. Ensure that the loop has had enough sample pass through by collecting the liquid that exits port 6 of the sample pretreatment valve. A good practice is to load at least four loop volumes. The method is set up so that the reagent reservoir pushes sample into the sample loop prior to the IC separation. By applying helium pressure at 34.5 kPa (5 psi) for 2.90 min ~3 mL will have been passed through the sample loop.
6. Ensure that the RP-1 pump is delivering at a consist rate of 0.55 ± 0.02 mL/min. Figure 8 illustrates what happens when the flow rate is faster or slower. At the slower flow rate, not enough of the sample is cut from the ICE separation, resulting in lower recovery of the analytes. Chloride response is reduced by half by varying flow rate from 0.55 mL/min to 0.50 mL/min in this example. Whereas at the faster flow rate, more of the ICE separation is cut resulting in a less optimum separation between glycolate, chloride, and carbonate.
7. Other factors will also affect the quality and consistency of the ICE preseparation. Changing the cut time window (7.0–14.0 min) specified in the method will impact the amount of analyte and matrix ions that are delivered to the concentrator column. Varying the sample volume will also affect the character of the ICE separation. Method development will be needed to ascertain the impact of any changes from the specified method.

Table 3 PeakNet Method for the Analysis of Concentrated Glycolic Acid

Total Time (min)	ICE Time (min)	IC Time (min)	Injection Valve	Column Valve	Relay 2	%A	Figure	Comments
Init			Inject	A	Open	100		
0.00			Inject	A	Closed	100	2	Begin loading the sample loop
2.90			Inject	A	Open	100	3	End loading the sample loop
3.00	0.00		Inject	B	Open	100		Begin ICE separation
10.00	7.00		Load	B	Open	100	4	Send cut portion from ICE separation to Concentrator column
17.00	14.00	0.00	Inject	B	Open	100	5	Begin IC separation. Concentrator column in-line
47.00		30.00	Inject	B	Open	100	5	End IC Separation

A = Inject, B = Load

8. Quantifying the levels of anions in glycolic acid is best accomplished by the method of standard additions. This involves adding one or more increments of a standard solution to sample aliquots of the same size (see *Calibration* section).

RESULTS AND DISCUSSION

A blank was determined by using deionized water as a sample. This is used to establish a background level of contamination present from the chromatographic pathway. The only anion present in significant concentration from the initial series of deionized water blanks was sulfate at approximately 130 µg/L, quantified based on sulfate standards in deionized water. A rinse of the column with deionized water for one hour followed by 25 replicate injections of deionized water blanks brought the blank down to 30 µg/L sulfate, as shown in Figure 9. This deionized water blank was subtracted from the levels found in the concentrated glycolic acid samples.

A chromatogram for the analysis of trace anions in 70% glycolic acid diluted 1:100 to 0.7% (v/v) is shown in Figure 10. The large glycolate matrix (peak beginning at 5 minutes) is well separated from chloride. Using an 8.0 mM carbonate / 1.5 mM sodium hydroxide eluent allows chloride to be well resolved from carbonate. Using an eluent gradient on a hydroxide selective column such as the IonPac AS10 or AS11 could have enhanced this separation between glycolate and chloride. The drawback of this approach is that the analysis time increases to 75 min. Thus the use of the AS9-HC represents the best compromise in separation efficiency and analysis time.

To verify proper quantification of analytes in the glycolic acid matrix, increasing concentrations of chloride and sulfate were added into the deionized water used to dilute the 70% glycolic acid. Spikes of 10, 30, and 100 µg/L of chloride and 300, 1000, and 3000 µg/L of sulfate yielded coefficients of determination (r^2) values of greater than 0.999.

Based on this calibration curve, a spike of 20 µg/L chloride, 500 µg/L sulfate yielded good recoveries as shown in Table 4.

To determine method precision for the method, a sample of glycolic acid diluted to 0.7% (v/v) was analyzed by this method. For n=7 replicate injections of the same sample, a relative standard deviation (RSD) of less than 10% was obtained for an average value of 11 µg/L chloride and 560 µg/L sulfate. Method detection limits (MDLs) were calculated using the standard deviation of seven replicate injections multiplied by the Student's t value for the 99.5% confidence level. MDLs for chloride and sulfate are in the low µg/L (ppb) range (see Table 5).

PRECAUTIONS

Exercise caution when handling concentrated glycolic acid. Consult the Material Safety Data Sheet (MSDS) for more specific details about protective equipment, reactivity, and health effects. Use only the highest quality deionized water for the preparation of standards and eluents. Any ionic contamination present in the deionized water will adversely affect results. Teflon containers are recommended for holding the concentrated acid samples for delivery to the sample loop. Containers should be soaked for at least 24 hours with 17.8 MΩ-cm deionized water prior to use. It is good practice to dedicate all containers for trace analysis and keep them filled with deionized water when not in use.

Method success depends on maintaining a consistent flow rate of deionized water from the RP-1 so that the proper fraction is cut from the ICE-AS6. Verify that the flow is 0.55 ± 0.02 mL/min. If the deionized water container feeding the RP-1 pump is not pressurized to at least 34.5 kPa (5 psi), the pump will be prone to losing prime.

Periodically rinse the Rheodyne valve used for loading sample. Residual glycolic acid can crystallize and block injector passages. Also, impurities present in the concentrated acid samples can lead to a loss of column capacity. This causes an increase in back pressure and shorter retention times. For more information, consult the IonPac AS9-HC column *Installation and Troubleshooting Guide*.

Do not leave concentrated glycolic acid in the sample loop and sample inlet lines for more than 6 hours. The PEEK tubing can degrade after extended contact time with the concentrated acidic sample.

Table 4 Spike Recovery of Trace Anions in 0.7% (v/v) Glycolic Acid

Anion	Glycolic Acid Blank (µg/L ± S.D.)	Spike (µg/L)	Found-blank (µg/L ± S.D.)	Recovery (%)
Chloride	10 ± 0.2	20	21 ± 0.3	105
Sulfate n=7	340 ± 3.0	500	558 ± 6.7	112

Table 5 Method Detection Limits for Trace Anions in 0.7% (v/v) Glycolic Acid

Anion	Method Detection Limits (µg/L)
Chloride	2
Sulfate	20

Method Detection Limit = (SD) x $(t_{\alpha})_{99.5\%}$ where (t_{α}) is for a single sided Student's t-test distribution for n=7.

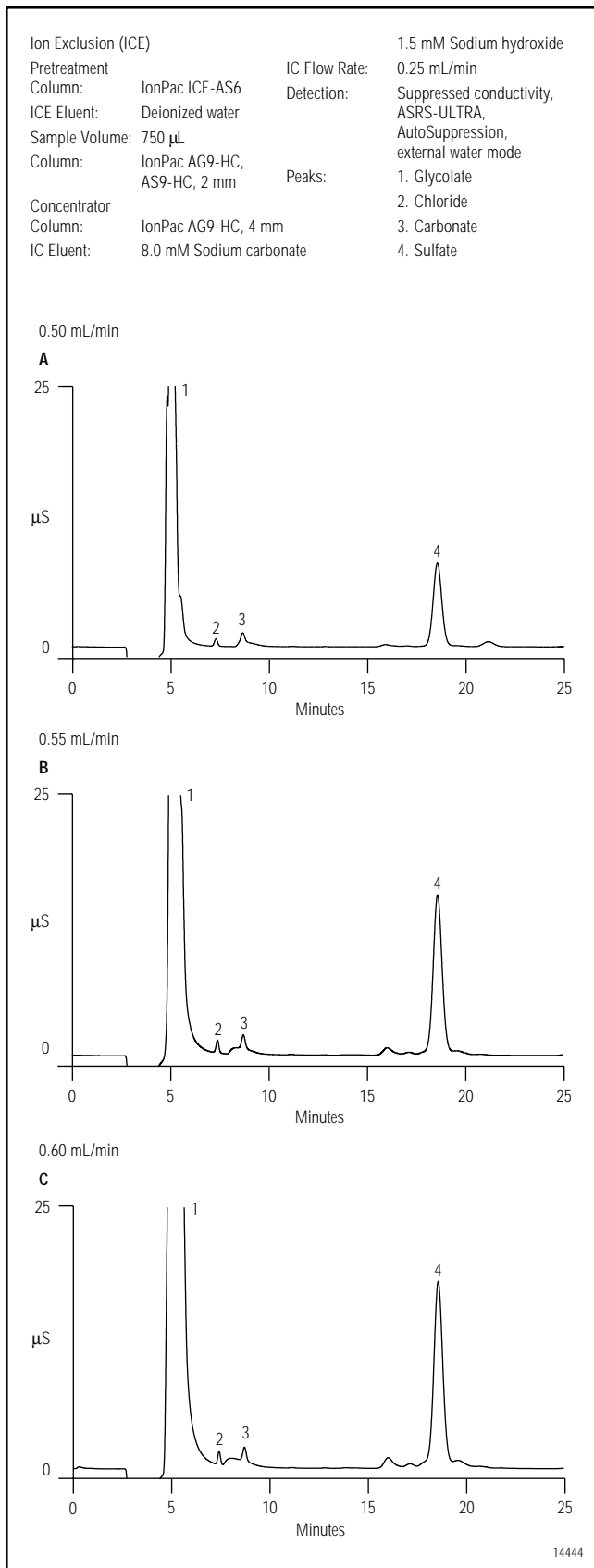

Figure 8. Effect of flow rate on ICE separation.

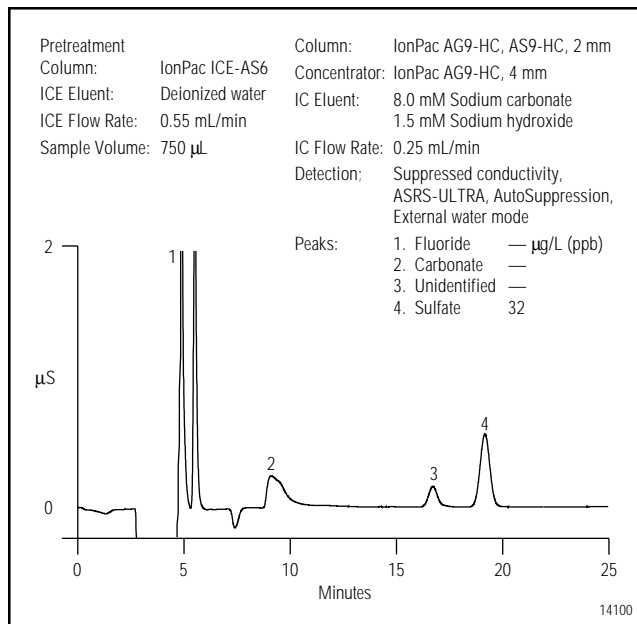

Figure 9. Representative system blank.

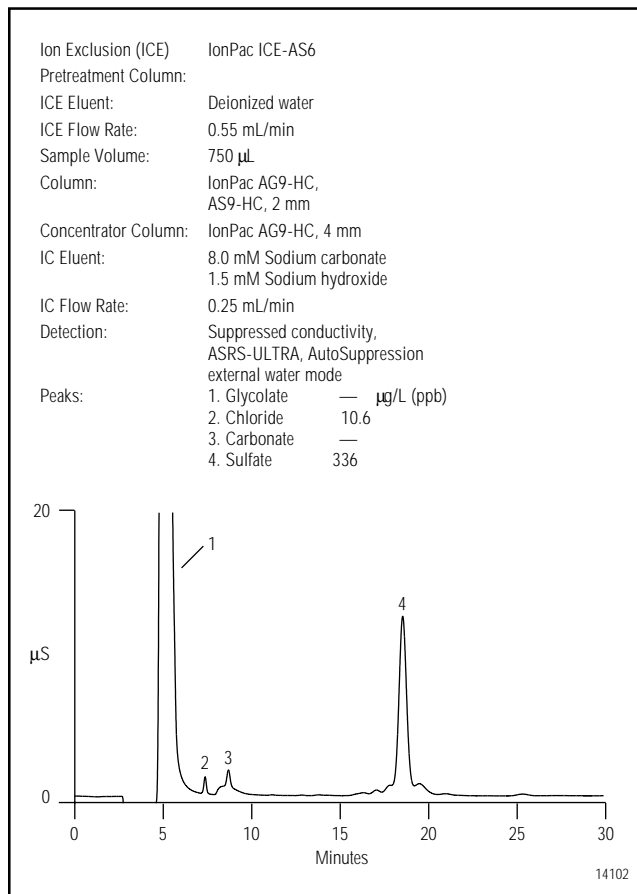

Figure 10. Trace anions in high purity glycolic acid.

REFERENCES

1. Sinclair, J.D. *J. Electrochem. Soc.* **1988**, *135*, 89–95C.
2. Dunn, M. *LCGC* **1989**, *7*, 138–139.
3. Watanabe, K. Presented at the International Ion Chromatography Symposium, Dallas, TX, October 1995; Poster 66.
4. Bader, M. *J. Chem. Educ.* **1980**, *57*, 730.
5. Weiss, J. *Ion Chromatography*, 2nd Ed., VCH, Weinheim, Germany, 1995, 209–210.
6. “Troubleshooting Guide for HPLC Injection Problems”, Rheodyne: Cotati, CA, 1992

LIST OF SUPPLIERS

Fisher Scientific, 711 Forbes Ave., Pittsburgh, PA
15219-4785, USA. Tel: (800) 766-7000

VWR Scientific, P.O. Box 7900, San Francisco, CA
94120, USA. Tel: (800) 932-5000

Lab Safety Supply Inc., P.O. Box 1368, Janesville, WI
53547-1368, USA. Tel: (800) 356-0722



IonPac, Anion Self Regenerating Suppressor, ASRS, and AutoSuppression are registered trademarks of Dionex Corporation.

ULTREX is a registered trademark of J.T Baker, Incorporated.



Printed on recycled and recyclable paper with soy-based inks.

Dionex Corporation
1228 Titan Way
P.O. Box 3603
Sunnyvale, CA
94088-3603
(408) 737-0700

Dionex Corporation
Salt Lake City Technical Center
1515 West 2200 South, Suite A
Salt Lake City, UT
84119-1484
(801) 972-9292

Dionex U.S. Regional Offices
Sunnyvale, CA (408) 737-8522
Westmont, IL (630) 789-3660
Houston, TX (281) 847-5652
Atlanta, GA (770) 432-8100
Marlton, NJ (856) 596-06009

Dionex International Subsidiaries

Austria (01) 616 51 25 *Belgium* (32) 3-353 42 94 *Canada* (905) 844-9650 *China* (852) 2428 3282 *Denmark* (45) 36 36 90 90
France 01 39 30 01 10 *Germany* 06126-991-0 *Italy* (06) 66 51 50 52 *Japan* (06) 6885-1213 *The Netherlands* (0161) 43 43 03
Switzerland (062) 205 99 66 *United Kingdom* (01276) 691722

* Designed, developed, and manufactured under an NSAI registered ISO 9001 Quality System.

