

Errata

Product Manual for Dionex IonPac™ AS25 and AG25 Columns
065443-03

For new orders of the following parts discussed in this manual, please use the updated part numbers listed below.

Part	Old Part Number in this manual	Updated Part Number to use for new orders
<i>PROD,COL,IP,ATC-3,4X35MM</i>	<i>059661</i>	<i>079932</i>
<i>PROD,COL,IP,UTAC-LP2,4X35MM</i>	<i>072779</i>	<i>079917</i>
<i>PROD,COL,IP,UTAC-ULP2,5X23MM</i>	<i>072780</i>	<i>079918</i>



Thermo Scientific

Dionex IonPac AS25 Columns

Product Manual

P/N: 065443-03

June 2012

Product Manual

for

Dionex IonPac[®] AG25 Guard Column

4 x 50 mm (P/N 076015)

2 x 50 mm (P/N 076017)

0.4 x 50 mm (PN: 076013)

Dionex IonPac[®] AS25 Analytical Column

4 x 250 mm (P/N 076014)

2 x 250 mm (P/N 076016)

0.4 x 250 mm (PN 076012)

© 2012 Thermo Fisher Scientific

Document No. 065443

Revision 03

June 2012

TABLE OF CONTENTS

SECTION 1 – INTRODUCTION.....	4
SECTION 2 – ION CHROMATOGRAPHY SYSTEMS.....	6
SECTION 3 – INSTALLATION.....	7
3.1. System Requirements.....	7
3.1.1. System Requirements for 0.4-mm Operation	7
3.1.2. System Requirements for 2 mm Operation.....	7
3.1.3. System Requirements for 4 mm Operation.....	7
3.1.4. System Void Volume.....	7
3.2. The Sample Concentrator.....	7
3.3. The Injection Loop	8
3.3.1. The 2 mm System Injection Loop, 2 - 15 μ L	8
3.3.2. The 4 mm System Injection Loop, 10 - 50 μ L.....	8
3.3.3. The 0.4 mm System Injection Loop, 0.4 μ L Internal Loop	8
3.4. The Dionex IonPac AG25 Guard Column	8
3.5. Dionex CR-ATC Trap Column Installation with Dionex EGC.....	9
3.6. Eluent Storage.....	9
3.7. Dionex Anion Self-Regenerating Suppressor or Dionex Anion Capillary Electrolytic Suppressor Requirements.....	9
3.8. Dionex Anion MicroMembrane Suppressor Requirements	9
3.9. Using Dionex Displacement Chemical Regeneration (DCR) in the Chemical Suppression Mode.....	10
3.10. Using the Dionex EGC-KOH with the Dionex IonPac AS25	10
3.11. Detector Requirements.....	10
3.12. Installation of the Capillary Column	10
SECTION 4 – OPERATION	14
4.1. General Operating Conditions	14
4.2. Dionex IonPac AS25 Operation Precautions	14
4.3. Chemical Purity Requirements	14
4.3.1. Inorganic Chemicals.....	14
4.3.2. Deionized Water	15
4.3.3. Solvents	15
4.4. Making Eluents that Contain Solvents	16
4.5. Eluent Preparation	16
4.5.1. Sodium Hydroxide Eluent Concentration.....	16
4.6. Regenerant Preparation for the Dionex AMMS 300.....	17

SECTION 5 – EXAMPLE APPLICATIONS	18
5.1. Recommendations for Optimum System Performance.....	18
5.2. Production Test Chromatograms.....	19
5.3. Isocratic Separation of Sulfur Species and Inorganic Anions Using the Dionex IonPac AS25 Column	20
5.4. Effect of Temperature on the Dionex IonPac AS25 Column.....	21
5.5. Separation of Common Anions and Polarizable Anions Using Gradient Elution	22
5.6. Determination of Inorganic Anions and Sulfur Species in Wastewater Samples Using Gradient Elution.....	23
5.7. Sulfur Species Analysis of Simulated Acid Gas Scrubber Solution Using the Dionex IonPac AS25 Column	24
5.8. Fast Isocratic Separation Using the Dionex IonPac AS25 Column.....	25
5.9. Artificial Sample of Volcanic Gas Condensate Separated on the Dionex IonPac AS25	26
5.10. Analysis of Anions Using the Dionex IonPac AS25 Capillary Column	27
SECTION 6 – TROUBLESHOOTING GUIDE	28
6.1. High Back Pressure	29
6.1.1. Finding the Source of High System Pressure	29
6.1.2. Replacing Column Bed Support Assemblies.....	30
6.1.3. Filter Eluent.....	31
6.1.4. Filter Samples.....	31
6.2. High Background or Noise.....	31
6.2.1. Preparation of Eluents	31
6.2.2. A Contaminated Trap Column.....	31
6.2.3. Contaminated Dionex CR-ATC Column.....	31
6.2.4. A Contaminated Guard or Analytical Column	31
6.2.5. Contaminated Hardware.....	32
6.2.6. A Contaminated Dionex ASRS 300, Dionex ACES 300 or Dionex AMMS 300 Suppressor.....	32
6.3. Poor Peak Resolution	32
6.3.1. Loss of Column Efficiency.....	32
6.3.2. Poor Resolution Due to Shortened Retention Times	33
6.3.3. Loss of Front End Resolution	34
6.3.4. Spurious Peaks.....	34
6.3.5. Poor Efficiency Using Capillary Columns	35
APPENDIX A –COLUMN CARE	36
A.1 Recommended Operating Pressure	36
A.2 Column Start-Up	36
A.3 Column Storage	36
A.4 Column Cleanup.....	36
A.4.1 Choosing the Appropriate Cleanup Solution	37
A.4.2 Column Cleanup Procedure.....	37
APPENDIX B – Configuration	38
ATTACHMENT A – Dionex IonPac AS25 Analytical, 2x250 mm	40
ATTACHMENT B – Dionex IonPac AS25 Analytical, 4x250 mm	41
ATTACHMENT C – Dionex IonPac AS25 Capillary, 0.4x250 mm.....	42

SECTION 1 – INTRODUCTION

The Dionex IonPac™ AS25 Column is a high capacity, hydroxide selective anion exchange column optimized for the separation of multivalent anions including polarizable anions (iodide, thiocyanate, and perchlorate) and for sulfur speciation (sulfite, sulfate, thiocyanate, and thiosulfate) in a variety of sample matrices. The Dionex IonPac AS25 is ideally suited for determination of sulfur species in wastewater effluents from chemical and petrochemical industries as well as for food and beverage samples. The Dionex IonPac AS25 column is available in 0.4 x 250 mm, 2 x 250 mm and 4 x 250 mm formats thus supporting a range of operating flow rates from 0.010 to 2.0 mL/min.

The Dionex IonPac AS25 column has a capacity of 350 µeq/column (4 x 250 mm). The high capacity of this column allows for direct large loop injections of complex samples without overloading the column. Under isocratic conditions, the polarizable anions can easily be separated in approximately 25 minutes.

The Dionex IonPac AS25 Capillary Column (0.4 x 250 mm) is packed with the same material as the equivalent standard bore version (producing the same performance as a 4 mm column), but requires only one-hundredth (1/100) the eluent flow rate. The capillary format has the advantage of less eluent consumption and waste generation, thus resulting in reduced operational costs.

Table 1
Dionex IonPac AS25/AG25 Packing Specification

Column	Particle Diameter µm	Substrate X-linking %	Column Capacity µeq/column	Functional Group	Hydrophobicity
Dionex IonPac AS25* 4 x 250 mm	7.5	55	350	Alkanol quaternary ammonium	Ultralow
Dionex IonPac AG25** 4 x 50 mm	13	55	3.5	Alkanol quaternary ammonium	Ultralow
Dionex IonPac AS25* 2 x 250 mm	7.5	55	87.5	Alkanol quaternary ammonium	Ultralow
Dionex IonPac AG25** 2 x 50 mm	13	55	0.875	Alkanol quaternary ammonium	Ultralow
Dionex IonPac AS25* 0.4 x 250 mm	7.5	55	3.5	Alkanol quaternary ammonium	Ultralow
Dionex IonPac AG25** 0.4 x 250 mm	13	55	0.035	Alkanol quaternary ammonium	Ultralow

* Analytical Column resin composition: supermacroporous polyvinylbenzyl ammonium polymer cross-linked with divinylbenzene.

** Guard Column resin composition: microporous polyvinylbenzyl ammonium polymer cross-linked with divinylbenzene.

Table 2
Dionex IonPac AS25/AG25 Operating Parameters

Column	Typical Back Pressure psi (MPa)	Standard Flow Rate mL/min	Maximum Flow Rate mL/min
Dionex IonPac AS25 4 mm Analytical	< 1,800 (12.41)	1.0	2.0
Dionex IonPac AG25 4 mm Guard	< 300 (2.07)	1.0	2.0
Dionex IonPac AS25 and AG25 4 mm columns	< 2,100 (14.48)	1.0	2.0
Dionex IonPac AS25 2 mm Analytical	< 1,800 (12.41)	0.25	0.5
Dionex IonPac AG25 2 mm Guard	< 300 (2.07)	0.25	0.5
Dionex IonPac AS25 and AG25 2 mm columns	< 2,100 (14.48)	0.25	0.5
Dionex IonPac AS25 0.4 mm Capillary	< 2,200 (15.17)	0.010	0.020
Dionex IonPac AG25 0.4 mm Capillary Guard	< 300 (2.07)	0.010	0.020
Dionex IonPac AS25 and AG25 0.4 mm Capillary and Capillary Guard	< 2500 (17.24)	0.010	0.020

*For assistance, contact Technical Support for Dionex Products. In the U.S., call 1-800-346-6390.
Outside the U.S., call the nearest Thermo Fisher Scientific office.*

SECTION 2 – ION CHROMATOGRAPHY SYSTEMS

The proper configuration of an Dionex Ion Chromatography System (ICS) in 2 mm or 4 mm format is based on the ratio of the 2 mm to 4 mm column cross-sectional area (a factor of 1/4). The selected format will affect the type of pump recommended. A gradient pump is designed to blend and pump isocratic, linear, or gradient mixtures of up to four mobile phase components at precisely controlled flow rates. An isocratic pump is for applications not requiring gradient and multi-eluent proportioning capabilities. Both are offered in either standard bore or microbore options.

- For an ICS in 2 mm format, a microbore isocratic pump, standard bore isocratic pump, microbore gradient pump, or standard bore gradient pump is recommended.
- For an ICS in 4 mm format, a standard bore isocratic pump or standard bore gradient pump is recommended.
- For an ICS in 0.4-mm format, a Capillary IC system such as the Thermo Scientific Dionex ICS-5000 system is recommended.

See Appendix B, "Configuration" for specific recommended settings and parts including pumps, eluent flow rate, Dionex Self-Regenerating Suppressor (SRS), Dionex MicroMembrane Suppressor (MMS), Dionex Capillary Electrolytic Suppressor (CES), injection loop, system void volume, detectors, and tubing back pressure.



Do not operate suppressors over 40 °C. If application requires a higher temperature, place the suppressor outside of the chromatographic oven. Use of a Dionex EG with a Dionex EGC III KOH (P/N 074532) cartridge for gradient applications is highly recommended for minimum baseline change when performing eluent step changes or gradients.

NOTE

changes or gradients.

SECTION 3 – INSTALLATION

3.1. System Requirements

3.1.1. System Requirements for 0.4-mm Operation

The Dionex IonPac AS25 0.4 mm Capillary Guard and Capillary Column are designed to be run on a capillary ion chromatograph system equipped with suppressed conductivity detection. It is recommended to run the capillary column only on the Dionex ICS-5000 capillary system for best performance.

3.1.2. System Requirements for 2 mm Operation

The Dionex IonPac AS25 2 mm Guard and Analytical Columns are designed to run on Thermo Scientific Dionex Ion Chromatographs equipped with suppressed conductivity detection. Isocratic analyses at flow rates of 0.5 mL/min can be performed on a pump with standard (1/8" pistons) pump heads. For isocratic analyses at flow rates below 0.5 mL/min and gradient analyses, a microbore pump (1/16" pistons) is recommended.

3.1.3. System Requirements for 4 mm Operation

The Dionex IonPac AS25 4 mm Guard and Analytical Columns are designed to run on any Dionex Ion Chromatograph equipped with suppressed conductivity detection. Gradient methods and methods requiring solvent containing eluents should be performed on a system having a pump with a standard pump heads (1/8" pistons). Isocratic analysis can also be performed on a pump with standard bore pump heads (1/8" pistons).

3.1.4. System Void Volume

When using 2 mm columns, it is particularly important to minimize system void volume. The system void volume should be scaled down to at least 1/4 of the system volume in a standard 4-mm system. For best performance, all of the tubing installed between the injection valve and detector should be 0.005" ID PEEK tubing (P/N 044221).

0.010" ID PEEK tubing (P/N 042260) may be used but peak efficiency will be compromised which may also result in decreased peak resolution. Minimize the lengths of all connecting tubing and remove all unnecessary switching valves and couplers.

3.2. The Sample Concentrator

The Dionex Trace Anion Concentrator Low Pressure Column (TAC-LP1, P/N 046026), the Dionex Trace Anion Concentrator Ultra Low Pressure Column (TAC-ULP1, P/N 061400), the Dionex Ultra Trace Anion Concentrator Low Pressure Column (UTAC-LP1, P/N 063079) or (UTACL P2, P/N 072779), the Dionex Ultra Trace Anion Concentrator Ultra Low Pressure Column (UTAC-ULP1, P/N 063475) or (UTAC-ULP2, P/N 072780), the Dionex Ultra Trace Anion Concentrator Extremely Low Pressure Column (UTAC-XLP1, P/N 063459) or (UTAC-XLP2, P/N 072781), or the Dionex IonPac AG25 Guard Column can be used for trace anion concentration work with the 2-mm and 4-mm Dionex IonPac AS25 columns. For trace anion concentration work with the 0.4-mm Dionex IonPac AS25 column, use the Dionex IonSwift MAC-100 or MAC-200 Concentrator Column. The function of a concentrator column in these applications is to strip ions from a measured volume of a relatively clean aqueous sample matrix. This process "concentrates" the desired analyte species onto the concentrator column, lowering detection limits by 2-5 orders of magnitude. The concentrator column is used in lieu of the sample loop.

Pump the sample onto the concentrator column in the OPPOSITE direction of the eluent flow. When using concentration techniques, do not overload the concentrator column by concentrating an excessive amount of sample. Concentrating an excessive amount of sample can result in inaccurate results being obtained. It is possible during the concentration step for the polyvalent anions such as phosphate and sulfate to elute the weakly retained anions such as fluoride and acetate off the concentrator column. For more detailed information on sample concentration techniques for high sensitivity work and a detailed discussion of anion concentration techniques refer to:

- Section 3, “Operation,” of the Dionex Trace Anion Concentrator Low Pressure (TAC-LP1) and Dionex Ultra Low Pressure (TAC-ULP1) Column Product Manual (Document No. 034972),
- Section 3, “Operation,” of the Dionex Ultra Trace Anion Concentrator Low Pressure (UTAC-LP1), Dionex Ultra Low Pressure (UTAC-ULP1), and Dionex Extremely Low Pressure (UTAC-XLP1) Column Product Manual (Document No. 065091.)
- Section 4, “Operation,” of the Dionex Ultra Trace Anion Concentrator 2 Low Pressure (UTAC-LP2), Dionex Ultra Low Pressure (UTAC-ULP2), and Dionex Extremely Low Pressure (UTAC-XLP2) Column Product Manual (Document No. 065376.)

**CAUTION**

Dionex IonPac Trace Anion Concentrator Column, TAC-2 (P/N 043101), is not optimized for use with hydroxide eluents and should not be used for concentrator work with the Dionex IonPac AS25. Instead, Concentrators (Dionex TAC-LP1, TAC-ULP1, UTAC 1, UTAC 2 or Dionex IonSwift MAC-100 or MAC-200) or Guards (Dionex IonPac AG25 4 mm or Dionex IonPac AG25 2 mm) should be used.

3.3. The Injection Loop

3.3.1. The 2 mm System Injection Loop, 2 - 15 μL

For most applications on a 2 mm analytical system, a 2 - 15 μL injection loop is sufficient. Generally, do not inject more than 12.5 nanomoles of any one analyte onto a 2 mm analytical column. Injecting larger number of moles of a sample can result in overloading the column which can affect the detection linearity. For low concentrations of analytes, larger injection loops can be used to increase sensitivity. The Dionex IonPac AS25 2 mm requires a microbore IC system configuration. Install an injection loop one-fourth or less ($<15 \mu\text{L}$) of the loop volume used with a 4-mm analytical system.

3.3.2. The 4 mm System Injection Loop, 10 - 50 μL

For most applications on a 4 mm analytical system, a 10 - 50 μL injection loop is sufficient. Generally, do not inject more than 50 nanomoles of any one analyte onto the 4 mm analytical column. Injecting larger number of moles of a sample can result in overloading the column which can affect the detection linearity. For low concentrations of analytes, larger injection loops can be used to increase sensitivity.

3.3.3. The 0.4 mm System Injection Loop, 0.4 μL Internal Loop

For most applications on a 0.4 mm capillary system, a 0.4 μL injection loop is sufficient. Generally, do not inject more than 0.5 nanomoles of any one analyte into a 0.4 mm capillary column. Injecting larger numbers of moles of a sample can result in overloading the column, which can affect the detection linearity. For samples containing low concentrations of analytes, larger injection loops can be used to increase sensitivity.

3.4. The Dionex IonPac AG25 Guard Column

A Dionex IonPac AG25 Guard Column is normally used with the Dionex IonPac AS25 Analytical/Capillary Column. Retention times will increase by approximately 4% when a guard column is placed in-line prior to the analytical/capillary column. A guard is placed prior to the analytical/capillary column to prevent sample contaminants from eluting onto the analytical/capillary column. It is easier to clean or replace a guard column than it is an analytical/capillary column. Replacing the Dionex IonPac AG25 Guard Column at the first sign of peak efficiency loss or decreased retention time will prolong the life of the Dionex IonPac AS25 Analytical/Capillary Column.

3.5. Dionex CR-ATC Trap Column Installation with Dionex EGC

For Dionex IonPac AS25 applications using the Dionex EGC KOH cartridge, a Dionex CR-ATC Continuously Regenerated Trap Column (P/N 060477 or 072078) should be installed at the Dionex EGC eluent outlet to remove trace level anionic contaminants from the carrier deionized water. See the Dionex CR-TC Product Manual (Document No. 031910) for instructions. As an alternative for 2 mm and 4 mm columns, the Dionex ATC-HC Trap Column (P/N 059604) should be installed between the pump outlet and the inlet of the Dionex EluGen Cartridge to remove anionic contaminants from the carrier deionized water. See the Dionex ATC-HC Product Manual (Document No. 032697) for instructions.

If the lower capacity Dionex ATC-3 Trap Column (P/N 059660 and 059661) is used with 2 mm and 4 mm columns, it should be installed between the gradient pump and the injection valve to remove anionic contaminants from the eluent. The Dionex ATC-3 column is used when performing sodium hydroxide gradient anion exchange applications using hand-prepared bottled eluents. See the Dionex ATC-3 Product Manual (Document No. 032697) for instructions.

The Dionex ATC-HC (P/N 059604) and Dionex ATC-3 Trap Columns will require off-line regeneration. To use the Dionex ATC-HC or Dionex ATC-3 Anion Trap Columns, refer to the Product Manuals.

3.6. Eluent Storage

Dionex IonPac AS25 columns are designed to be used with hydroxide eluent systems. Storage under a helium atmosphere ensures contamination free operation and proper pump performance. Nitrogen can be used if eluents do not contain solvents.

3.7. Dionex Anion Self-Regenerating Suppressor or Dionex Anion Capillary Electrolytic Suppressor Requirements

A Dionex Anion Self-Regenerating Suppressor should be used for applications that require suppressed conductivity detection. It is compatible with solvent containing eluents and aqueous ionic eluents of all concentrations with which the systems and columns are compatible. Aqueous ionic eluents can be used in all Dionex ASRS 300 modes of operation.



Solvent containing eluents should be used in the AutoSuppression External Water Mode.

CAUTION

- For Dionex IonPac AS25 4 mm Analytical Column, use the Dionex ASRS 300 4 mm (P/N 061561).
- For Dionex IonPac AS25 2 mm Analytical Column, use the Dionex ASRS 300 2 mm (P/N 061562).
- For Dionex IonPac AS25 0.4 mm Capillary Column, use the Dionex ACES 300 0.4 mm (P/N 072052).

For detailed information on the operation of the Dionex Anion Self-Regenerating Suppressor 300, see the Product Manual for the Dionex ASRS 300 (Document No. 031956).

For detailed information on the operation of the Dionex Anion Capillary Electrolytic Suppressor 300, see the Product Manual for the Dionex ACES 300 (Document No. 065386).

3.8. Dionex Anion MicroMembrane Suppressor Requirements

A Dionex Anion MicroMembrane Suppressor (AMMS 300) may be used instead of a Dionex ASRS 300 4 mm for applications that require suppressed conductivity detection. Use a Dionex AMMS 300 4 mm (P/N 064558) with the Dionex IonPac AS25 4 mm Analytical Column. It is compatible with all solvents and concentrations with which the systems and columns are compatible. For 2 mm operation, use the Dionex AMMS 300 2 mm (P/N 064559).

For detailed information on the operation of the Dionex Anion MicroMembrane Suppressor, see Document No. 031727, the Product Manual for the Dionex AMMS 300.

3.9. Using Dionex Displacement Chemical Regeneration (DCR) in the Chemical Suppression Mode

The Dionex Displacement Chemical Regeneration (Dionex DCR) Mode is recommended for chemical suppression using sulfuric acid and the Dionex Anion MicroMembrane Suppressor (Dionex AMMS 300). See the Dionex DCR kit manual, Document P/N 031664, for details.



Use proper safety precautions in handling acids and bases.

SAFETY

3.10. Using the Dionex EGC-KOH with the Dionex IonPac AS25

The Dionex IonPac AS25 column is recommended for use with Thermo Scientific Dionex ICS-2100, or Dionex ICS-5000 IC Systems equipped with a Dionex Eluent Generator. The Dionex Eluent Generator is used to automatically produce potassium hydroxide gradients from deionized water. The Dionex IonPac AS25 can be used with older Dionex IC Systems equipped with an Eluent Generator or a Dionex RFC-30 Reagent Free Controller. Please refer to the Dionex EG40 manual, Document No. 031373, for information on the operation of the Dionex EG40. Please refer to the Dionex EG50 Product Manual, Document No. 031908, for information on the operation of the Dionex EG50.

3.11. Detector Requirements

See Section 2, "Ion Chromatography Systems," for 2 mm, 4 mm and 0.4 mm system detector, cell and thermal stabilizer requirements.

3.12. Installation of the Capillary Column

1. Before installing the new separator column, cut off the column label and slide it into the holder on the front of the cartridge (see Figure 6).
2. For reference, Figure 1 shows the column cartridge after installation of both a capillary guard column and a capillary separator column. Figure 2 shows the column cartridge after installation of only a capillary separator column.

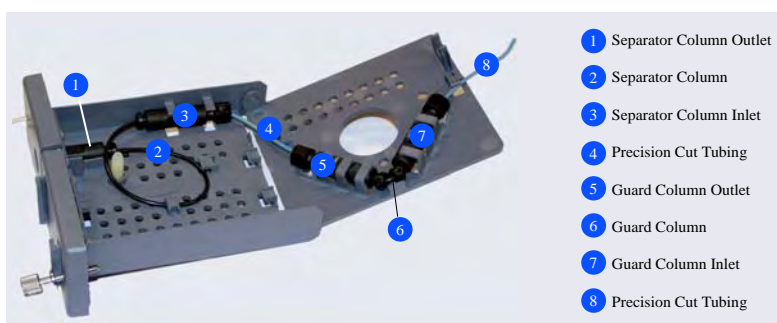

Figure 1
Separator and Guard Columns Installed in Column Cartridge

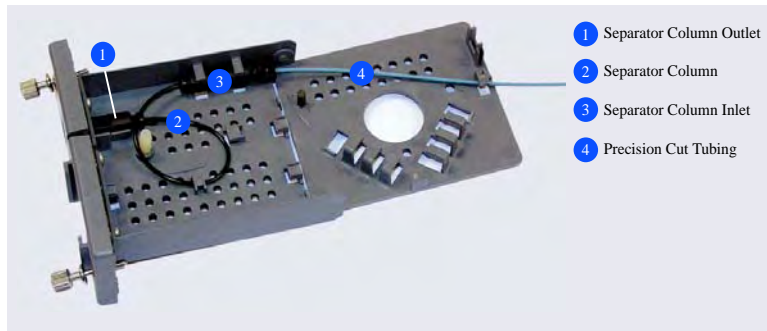

Figure 2
Separator Column Only Installed in Column Cartridge

3. Locate the Dionex IC Cube Tubing Kit (P/N 072186) that is shipped with the Dionex IC Cube. The tubing kit includes the following items:

Table 3
Contents of the Dionex IC Cube Tubing Kit (P/N 072186)

Part	Length / Quantity	Part Number	Used To Connect...
Precision cut 0.062 mm (0.0025-in) ID PEEK tubing, blue	65 mm (2.56 in)	072188	50 mm guard column outlet to 250 mm separator column inlet
Precision cut 0.062 mm (0.0025-in) ID PEEK tubing, blue, labeled VALVE PORT 3	115 mm (4.53 in)	072189	Guard column inlet to injection valve
Precision cut 0.062 mm (0.0025-in) ID PEEK tubing, blue	75 mm (2.93 in)	074603	35 mm guard column outlet to 150 mm separator column inlet
Precision cut 0.062 mm (0.0025-in) ID PEEK tubing, blue, labeled VALVE PORT 3	210 mm (8.27 in)	072187	Separator column inlet to injection valve (if a guard column is not present)
0.25 mm (0.010-in) ID PEEK tubing, black	610 mm (24 in)	042690	EG degas cartridge REGEN OUT to waste (if an EG is not present)
Fitting bolt, 10-32 hex double-cone (smaller), black	3	072949	Connect precision cut 0.062 mm (0.0025-in) ID PEEK tubing
Fitting bolt, 10-32 double-cone (larger), black	1	043275	Connect 0.25 mm (0.010-in) ID PEEK tubing (black)
Ferrule fitting, 10-32 double-cone, tan	4	043276	Use with both sizes of fitting bolts

4. Refer to the following figures for the precision cut tubing required for your configuration:

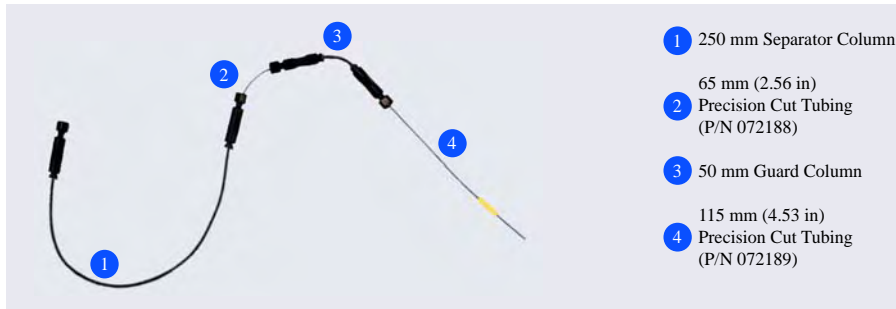

Figure 3
Tubing Connections for 250 mm Separator Column and 50 mm Guard Column



Figure 4
Tubing Connections for Separator Column Only

- Lift up the lid of the column cartridge to open it.
- Remove the fitting plug from the outlet fitting on the separator column. Orient the fitting with a flat side up (see Figure 5) and push the fitting into the opening at the front of the column cartridge until it stops.

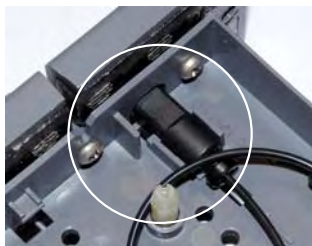

Figure 5
Column Outlet Fitting Installed in Column Cartridge

- Coil the separator column tubing inside the cartridge as shown in Figure 1 or Figure 2. Secure the column tubing and the inlet fitting in the clips on the column cartridge.
- Secure the inlet and outlet fittings on the guard column (if used) in the column clips on the lid of the column cartridge.
- Route the guard column inlet tubing (if used) or the separator column inlet tubing through the clip on the top edge of the column cartridge lid.
- Close the lid (you should hear a click) and route the tubing into the slot on the front of the column cartridge (see Figure 6).



NOTE

If the columns are installed correctly, the cartridge lid snaps closed easily. If the lid does not close easily, do not force it. Open the lid and verify that the columns and tubing are installed correctly and secured in the clips.



Figure 6
Column Cartridge Closed

SECTION 4 – OPERATION

4.1. General Operating Conditions

Sample Volume:	2 mm: 2.5 μ L Loop + 0.8 μ L Injection valve dead volume 4 mm: 10 μ L Loop + 0.8 μ L Injection valve dead volume 0.4 mm: 0.4 μ L Loop
Column:	2 mm: Dionex IonPac AS25 2 mm Analytical Column + Dionex IonPac AG25 2 mm Guard Column 4 mm: Dionex IonPac AS25 4 mm Analytical Column + Dionex IonPac AG25 4 mm Guard Column 0.4 mm: Dionex IonPac AS25 0.4 mm Capillary Column + Dionex IonPac AG25 0.4 mm Capillary Guard Column
Eluent:	36 mM KOH
Eluent Source:	Dionex EGC III KOH
Eluent Flow Rate:	2 mm: 0.25 mL/min 4 mm: 1.0 mL/min 0.4 mm: 0.010 mL/min
Temperature:	30 °C
Dionex SRS Suppressor:	Dionex Anion Self-Regenerating Suppressor, Dionex ASRS 300 (2 mm or 4 mm) Dionex Anion Capillary Electrolytic Suppressor, Dionex ACES 300 (0.4 mm) AutoSuppression Recycle Mode
or Dionex MMS Suppressor:	Dionex Anion MicroMembrane Suppressor, Dionex AMMS 300 (2 mm or 4 mm)
Dionex MMS Regenerant:	50 mN H ₂ SO ₄
Expected Background Conductivity:	< 1 μ S
Long-term Storage Solution (> 1 week):	100 mM Sodium Borate
Short-term Storage Solution (< 1 week):	Eluent

4.2. Dionex IonPac AS25 Operation Precautions

- a) Filter and Degas Eluents

Table 4
Filter and Degas Eluents

FILTER SAMPLES	
Eluent pH	Between 0 and 14
Sample pH	Between 0 and 14
Maximum Flow Rate for 2 mm Columns	0.5 mL/min
Maximum Flow Rate for 4 mm Columns	2.0 mL/min
Maximum Flow Rate for 0.4 mm Columns	0.020 mL/min
Maximum Operating Pressure	3,000 psi (20.68 MPa)

4.3. Chemical Purity Requirements

Obtaining reliable, consistent and accurate results requires eluents that are free of ionic impurities. Chemicals, solvents and deionized water used to prepare eluents must be of the highest purity available. Low trace impurities and low particle levels in eluents also help to protect your ion exchange columns and system components. Thermo Fisher Scientific cannot guarantee proper column performance when the quality of the chemicals, solvents and water used to prepare eluents has been compromised.

4.3.1. Inorganic Chemicals

Reagent Grade inorganic chemicals should always be used to prepare ionic eluents. Whenever possible, inorganic chemicals that meet or surpass the latest American Chemical Society standard for purity should be used. These inorganic chemicals will detail the purity by having an actual lot analysis on each label.

4.3.2. Deionized Water

The deionized water used to prepare eluents should be Type I Reagent Grade Water with a specific resistance of 18.2 megohm-cm. The deionized water should be free of ionized impurities, organics, microorganisms and particulate matter larger than 0.2 μm . Bottled HPLC-Grade Water (with the exception of Burdick & Jackson) should not be used since most bottled water contains an unacceptable level of ionic impurities.

4.3.3. Solvents

Solvents can be added to the ionic eluents used with Dionex IonPac AS25 columns to modify the ion exchange process or improve sample solubility. The solvents used must be free of ionic impurities. However, since most manufacturers of solvents do not test for ionic impurities, it is important that the highest grade of solvents available be used. Currently, several manufacturers are making ultra high purity solvents that are compatible for HPLC and spectrophotometric applications. These ultra high purity solvents will usually ensure that your chromatography is not affected by ionic impurities in the solvent. Currently at Thermo Fisher Scientific, we have obtained consistent results using Optima[®] Solvents by Fisher Scientific.

When using a solvent in an ionic eluent, column generated back pressures will depend on the solvent used, concentration of the solvent, the ionic strength of the eluent and the flow rate used. The column back pressure will vary as the composition of water-methanol and water-acetonitrile mixture varies. The maximum back pressure limit for the Dionex IonPac AS25 columns is 3,000 psi (20.68 MPa).

The Dionex IonPac AS25 can withstand common HPLC solvents in a concentration range of 0-100%. Solvents and water should be premixed in concentrations which allow proper mixing by the gradient pump and to minimize outgassing. Ensure that all of the inorganic chemicals are soluble in the highest solvent concentration to be used during the analysis.

Table 5
HPLC Solvents for Use with Dionex IonPac AS25 Columns

Solvent	Maximum Operating Concentration
Acetonitrile	100%
Methanol	100%
2-Propanol	100%
Tetrahydrofuran	20%*
*Higher concentration may only be used for limited duration applications such as column clean up at pressures < 2000 psi.	



The Dionex ASRS 300 and the Dionex ACES 300 must be operated in the AutoSuppression External Water Mode when using eluents containing solvents. Do not use > 40% solvent on the Dionex ASRS 300 and the Dionex ACES 300 in the electrolytic mode (power on).

4.4. Making Eluents that Contain Solvents

When mixing solvents with water, remember to mix on a volume to volume basis. For example, if a procedure requires an eluent of 90% acetonitrile, prepare the eluent by adding 900 mL of acetonitrile to an eluent reservoir. Then add 100 mL of deionized water or eluent concentrate to the acetonitrile in the reservoir. Using this procedure to mix solvents with water will ensure that a consistent true v/v eluent is obtained. Premixing water with solvent will minimize the possibility of out gassing.



NOTE

When purging or degassing eluents containing solvents, do not purge or degas the eluent excessively since it is possible that a volatile solvent can be “boiled” off from the solution.



NOTE

Always degas and store all eluents in glass or plastic eluent bottles pressurized with helium. Only helium can be used to purge and degas ionic eluents containing solvents, since nitrogen is soluble in solvent containing eluents.



NOTE

Acetonitrile (ACN) hydrolyzes to ammonia and acetate when left exposed to basic solutions. To prevent eluent contamination from acetonitrile hydrolysis, always add acetonitrile to basic aqueous eluents by proportioning the acetonitrile into the basic eluent with the gradient pump. Keep the acetonitrile in a separate eluent bottle containing only acetonitrile and water.



SAFETY

Never add the acetonitrile directly to the basic carbonate or hydroxide eluent solutions.

4.5. Eluent Preparation

4.5.1. Sodium Hydroxide Eluent Concentration

4.5.1.1. Weight Method

When formulating eluents from 50% sodium hydroxide, it is recommended to weigh out the required amount of 50% sodium hydroxide. Use Fisher Grade 50% sodium hydroxide. Do not use pellets.

Example: To make 1 L of 35 mM NaOH use 2.80 g of 50% sodium hydroxide:

$$\text{For 36 mM: } \frac{0.036 \text{ mole/L} \times 40.00 \text{ g/mole}}{50\%} = 2.88 \text{ g diluted to 1 L}$$

4.5.1.2. Volume Method

Although it is more difficult to make precise carbonate-free eluents for gradient analysis volumetrically, you may choose to use the following formula to determine the correct volume of 50% sodium hydroxide to be diluted.

$$g = dvr$$

Where: g = weight of sodium hydroxide required (g)
 * d = density of the concentrated solution (g/mL)
 v = volume of the 50% sodium hydroxide required (mL)
 r = % purity of the concentrated solution

Example: To make 1 L of 35 mM NaOH use 1.83 mL of 50% sodium hydroxide:

$$\text{For 36 mM: } \frac{0.036 \text{ mole/L} \times 40.00 \text{ g/mole}}{50\% \times 1.53 \text{ g/mL}} = 1.88 \text{ mL diluted to 1 L}$$

* This density applies to 50% NaOH. If the concentration of the NaOH solution is significantly different from 50%, the upper (weight method) calculation should be used instead.

4.5.1.3. Sodium Hydroxide Eluents

Dilute the amount of 50% (w/w) NaOH (in water) specified in Table 6, "Dilution of 50% (w/w) NaOH to make standard Dionex IonPac AS25 eluents" with degassed, deionized water (with a specific resistance of 18.2 megohm-cm) to a final volume of 1,000 mL using a volumetric flask. Avoid the introduction of carbon dioxide from the air into the aliquot of 50% (w/w) NaOH or the deionized water being used to make the eluent. Do not shake the 50% (w/w) NaOH or pipette the required aliquot from the top of the solution where sodium carbonate may have formed.

Table 6
Dilution of 50% (w/w) NaOH to Make Standard Dionex IonPac AS25 Eluents

50% (w/w) NaOH g (mL)	Concentration of NaOH Eluent (mM)
0.40 (0.26)	5
2.8 (1.83)	35
8.00 (5.25)	100
160.00 (104.6)	2 M

4.6. Regenerant Preparation for the Dionex AMMS 300

The Dionex Anion MicroMembrane Suppressor 300 (Dionex AMMS 300) requires the use of a regenerant solution. If you are using the Dionex AMMS 300 instead of the Dionex Anion Self-Regenerating Suppressor 300 (Dionex ASRS 300), see the Product Manual for the Dionex AMMS 300 (Document No. 031727).

SECTION 5 – EXAMPLE APPLICATIONS

5.1. Recommendations for Optimum System Performance

The chromatograms in this section were obtained using columns that reproduced the Production Test Chromatogram (see Attachments, “QUALITY ASSURANCE REPORT”) on optimized Ion Chromatographs. Different systems will differ slightly in performance due to slight differences in column sets, system void volumes, liquid sweep-out times of different components and laboratory temperatures.

The Dionex IonPac AS25 is designed for the determination of polarizable anions and sulfur species using eluent delivered with a Dionex EGC KOH cartridge. Resolution of specific analytes can be further optimized if necessary by using gradient elution. In any type of gradient elution system it is important to use eluents that produce a minimum shift in baseline conductivity during the run, as well as a fast equilibration time from one run to the next. Because sodium or potassium hydroxide is converted to water in the suppressor, it is the best choice for an eluent. As long as the capacity of the suppressor is not exceeded, the eluent hydroxide concentration has little effect on background conductivity. For example, a gradient run could begin at 1.0 mM KOH and end at 80 mM KOH, with a resulting total baseline change of 1 to 2 μS .

DOWNWARD SHIFT IN BASELINE

Ensure that adequate equilibration time is allowed between runs. If downward shift in baseline is observed during the isocratic section of the chromatogram, increase the equilibration time.

INCREASE THE SENSITIVITY

You can increase the sensitivity of your system by using sample concentration techniques (see Section 3).



CAUTION

Carbon dioxide readily dissolves in dilute basic solutions forming carbonate. Carbonate contamination of eluents can affect the retention times of the anions being analyzed. Eluents should be maintained under an inert helium atmosphere to avoid carbonate contamination.

5.2. Production Test Chromatograms

Isocratic elution of inorganic anions including polarizable anions on the Dionex IonPac AS25 Analytical/Capillary Column has been optimized utilizing a hydroxide eluent. By using this eluent, common inorganic anions including polarizable anions can be used to test the performance of the Dionex IonPac AS25 Column. The Dionex IonPac AS25 Analytical/Capillary Column should always be used with the Dionex IonPac AG25 Guard Column. To guarantee that all Dionex IonPac AS25 Analytical/Capillary Columns meet high quality and reproducible performance specification standards, all columns undergo the following production control test. An operating temperature of 30 °C is used to ensure reproducible resolution and retention. Note that the Dionex IonPac AG25 Guard is packed with a microporous resin of proportionally lower capacity and contributes approximately 4 % increase in retention times when a guard column is placed in-line prior to the analytical/capillary column.

Sample Volume:	0.4 mm: 0.4 µL Loop 2 mm: 2.5 µL Loop + 0.8 µL Injection valve dead volume 4 mm: 10 µL Loop + 0.8 µL Injection valve dead volume See chromatogram	Analyte	mg/L
Column:		1. Fluoride	2
Eluent:	36 mM KOH	2. Chloride	3
Eluent Flow Rate:	0.25 mL/min (2 mm), 1.0 mL/min (4 mm), 0.010 mL/min (0.4 mm)	3. Sulfate	5
Operating Temperature:	30°C	4. Thiosulfate	10
Dionex SRS Suppressor:	Dionex Anion Self-Regenerating Suppressor, Dionex ASRS 300 (2 mm or 4 mm) Dionex Anion Capillary Electrolytic Suppressor, Dionex ACES 300, AutoSuppression® Recycle Mode	5. Iodide	20
or Dionex MMS Suppressor:	Dionex Anion MicroMembrane Suppressor, Dionex AMMS 300 (2 mm or 4 mm)	6. Thiocyanate	20
Dionex MMS Regenerant:	50 mN H ₂ SO ₄	7. Perchlorate	30
Expected Background Conductivity:	< 3 µS		
Long-term Storage Solution (> 1 week):	100 mM Sodium Borate		
Short-term Storage Solution (< 1 week):	Eluent		

Dionex IonPac AS25 4 mm Analytical Column Only

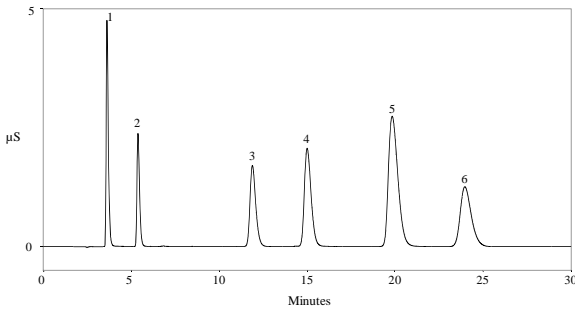

Dionex IonPac AS25 2 mm Analytical Column Only

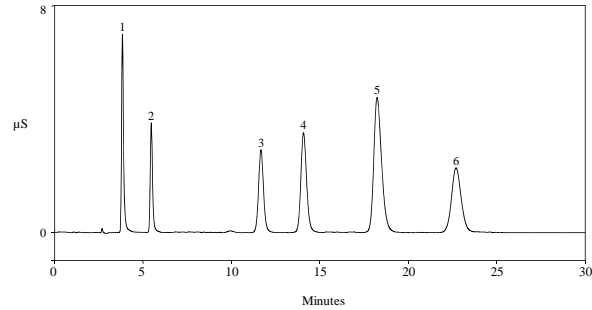

Dionex IonPac AS25 4 mm and AG25 4 mm Analytical & Guard Columns

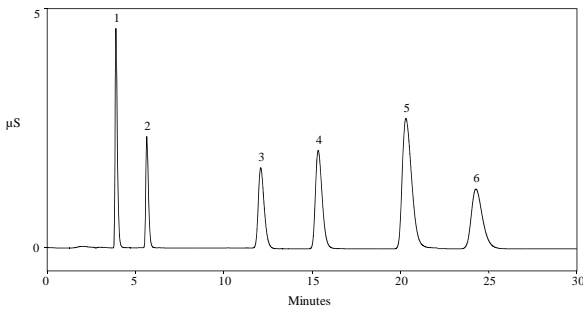

Dionex IonPac AS25 2 mm and AG25 2 mm Analytical & Guard Columns

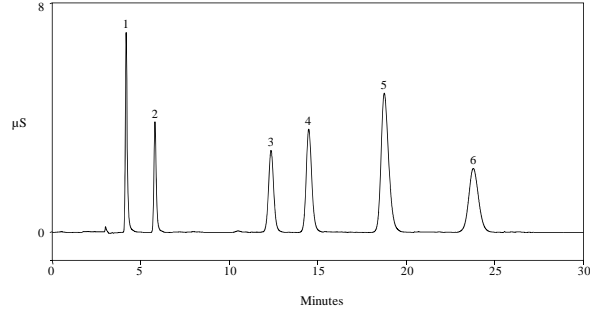

**Figure 7
Production Test Chromatograms**

5.3. Isocratic Separation of Sulfur Species and Inorganic Anions Using the Dionex IonPac AS25 Column

The Dionex IonPac AS25 column has been optimized for the fast, isocratic determination of polarizable anions such as thiosulfate, iodide, thiocyanate, and perchlorate in less than 25 min without the use of solvent, as shown here.



Sulfate and Sulfite are baseline resolved with the Dionex IonPac AS25 column.

NOTE

Column: Dionex IonPac AS25 Analytical, 4 mm
Eluent: 37 mM KOH
Eluent Source: Dionex EGC III KOH
Flow rate: 1 mL/min
Inj. Volume: 25 μ L
Temperature: 30 $^{\circ}$ C
Detection: Suppressed conductivity,
Dionex ASRS 300 4 mm,
AutoSuppression,
recycle mode, 92 mA

Analyte

1. Fluoride
2. Bromate
3. Chloride
4. Nitrite
5. Bromide
6. Nitrate
7. Carbonate
8. Sulfite
9. Sulfate
10. Iodide
11. Thiocyanate
12. Perchlorate
13. Thiosulfate

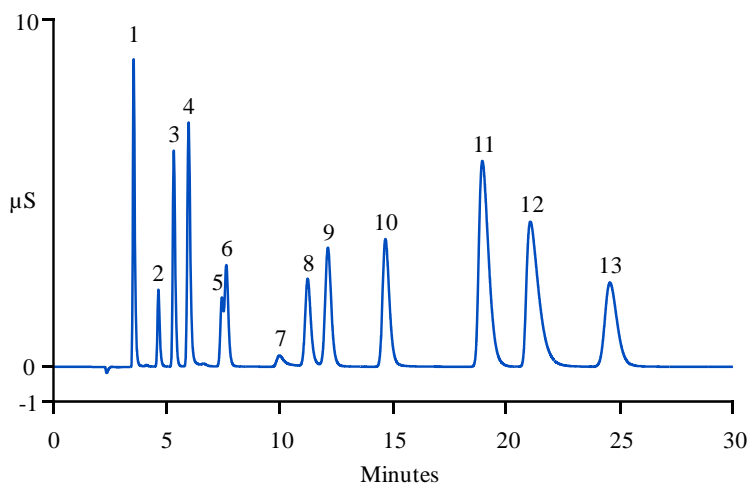

Figure 8
Isocratic Separation of Sulfur Species and Inorganic Anions
Using the Dionex IonPac AS25 Column

5.4. Effect of Temperature on the Dionex IonPac AS25 Column

The following chromatograms show the effect of temperature on the analyte retention time on the Dionex IonPac AS25 column. The retention times of sulfate and thiosulfate are increased at room temperature while the other analytes remain at basically the same retention time from 25°C to 35°C.

Sample Volume:	10 µL		
Column:	Dionex IonPac AS25 Analytical, 4 mm		
Eluent:	36 mM KOH	Analyte	mg/L
Eluent Flow Rate:	1.0 mL/min	1. Fluoride	2
Operating Temperature:	A) 25°C	2. Chloride	3
	B) 30°C	3. Sulfate	5
	C) 35°C	4. Iodide	20
Detection:	Suppressed Conductivity, Dionex ASRS 300	5. Thiocyanate	20
	(4 mm), AutoSuppression, recycle Mode	6. Thiosulfate	10

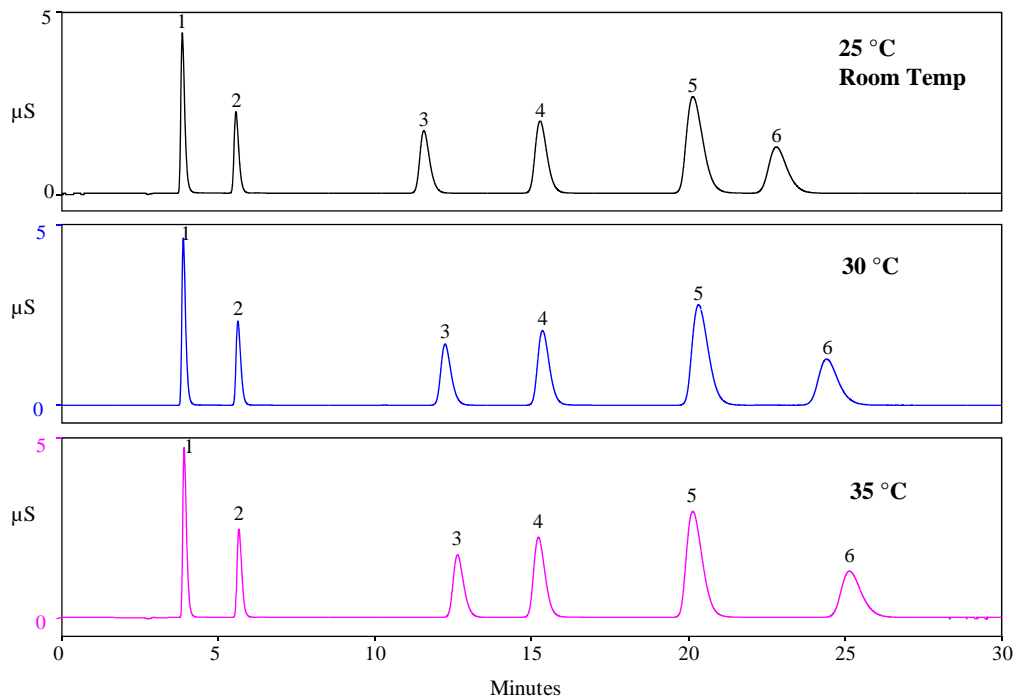

Figure 9
Effect of Temperature on Retention Time

5.5. Separation of Common Anions and Polarizable Anions Using Gradient Elution

The following chromatogram demonstrates the separation of common anions and polarizable anions using hydroxide gradient elution.

Injection volume: 10 μ L
Column: Dionex IonPac AG25/AS25 4 mm
Eluent: Potassium hydroxide: 5mM to 15mM from 0 to 10 min; from 15 to 30mM from 10 to 20 min and 30mM to 60mM from 20 min to 38 min.
Eluent Source: Dionex EGC III KOH Cartridge with Dionex CR-ATC
Flow Rate: 1 mL/min
Temperature: 30 $^{\circ}$ C
Detection: Suppressed Conductivity, Dionex Anion Self-Regenerating Suppressor (Dionex ASRS 300, 4 mm) AutoSuppression, recycle mode

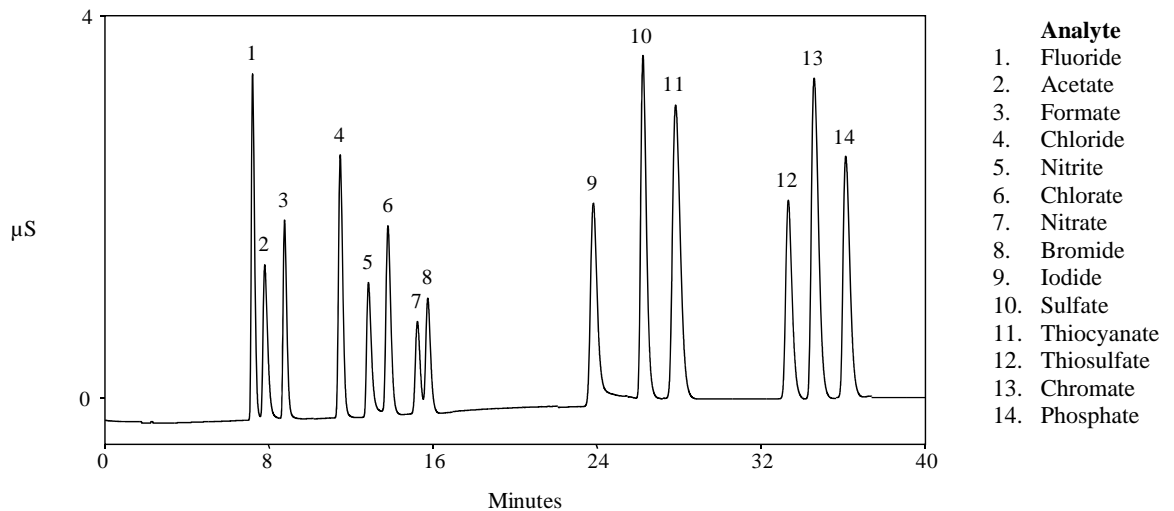

Figure 10
Separation of Common Anions and Polarizable Anions Using Gradient Elution

5.6. Determination of Inorganic Anions and Sulfur Species in Wastewater Samples Using Gradient Elution

The Dionex IonPac AS25 is also useful for analysis of waste water. The chromatograms below show the analysis of raw and finished waste water samples containing common anions, including phosphate, with a run time of less than 30 minutes. The column shows excellent resolution of carbonate from sulfate. The lower chromatogram shows analysis of a finished waste water sample spiked with sulfite and thiosulfate. These sulfur containing oxyanions can also be quantitated using this column under the described gradient conditions.



Sulfate and Sulfite are baseline resolved with the Dionex IonPac AS25 column.

NOTE

Sample Volume:	25 μ L
Column:	Dionex IonPac AG25/AS25 4 mm
Eluent :	Potassium Hydroxide: 1 mM from 0 to 3.5 min, 1–20 mM from 3.5 to 7 min, 20–45 mM from 7 to 20 min, 45 mM from 20 to 30 min
Eluent Source:	Dionex EGC III KOH Cartridge with Dionex CR-ATC
Eluent Flow Rate:	2 mL/min
Operating Temperature:	30 $^{\circ}$ C
Detection:	Suppressed Conductivity, Dionex ASRS 300 (4 mm) AutoSuppression, recycle mode, 223 mA
Sample A:	Wastewater
Sample B:	Wastewater spiked with sulfite and thiosulfate

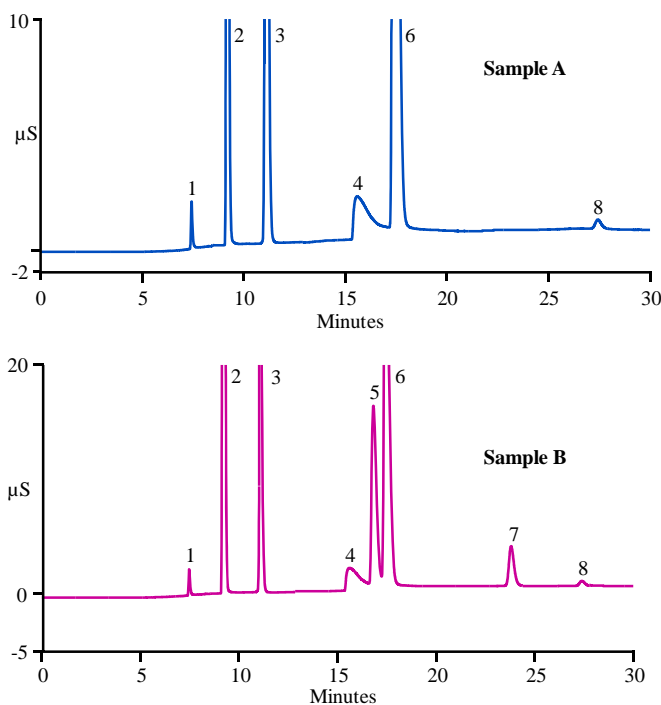

- Analyte**
1. Fluoride
 2. Chloride
 3. Nitrate
 4. Carbonate
 5. Sulfite
 6. Sulfate
 7. Thiosulfate
 8. Phosphate

Figure 11
Determination of Inorganic Anions and Sulfur Species in Wastewater Samples Using the Dionex IonPac AS25 Column

5.7. Sulfur Species Analysis of Simulated Acid Gas Scrubber Solution Using the Dionex IonPac AS25 Column

Acid gases such as hydrochloric acid (HCl), hydrofluoric acid (HF), phosgene (COCl₂), chlorine (Cl₂), and hydrogen sulfide (H₂S) are removed from caustic scrubbers in industrial processes. The purpose of the caustic scrubber is to prevent exposure of the acid gases to the environment. Effectiveness of these scrubbers is established by frequent analysis. The figure below shows the application of the analysis of a simulated acid gas scrubber sample consisting of 3% base. The sample was diluted 10-fold in the below application. For higher concentrations of scrubber solutions, a Dionex ASRN™ 300 could be used to neutralize the alkaline samples.

Sample Volume:	25 µL
Column:	Dionex IonPac AG25/AS25 4 mm
Eluent :	Potassium hydroxide: 20 mM from 0 to 5 min, 20 - 45 mM from 5 to 15 min, and 45mM from 15 to 30 min
Eluent Source:	Dionex EGC III KOH Cartridge with Dionex CR-ATC
Eluent Flow Rate:	2.0 mL/min
Operating Temperature:	30 °C
Detection:	Suppressed Conductivity, Dionex ASRS (4 mm) AutoSuppression, recycle mode, 223 mA
Sample:	3% base diluted 10- fold

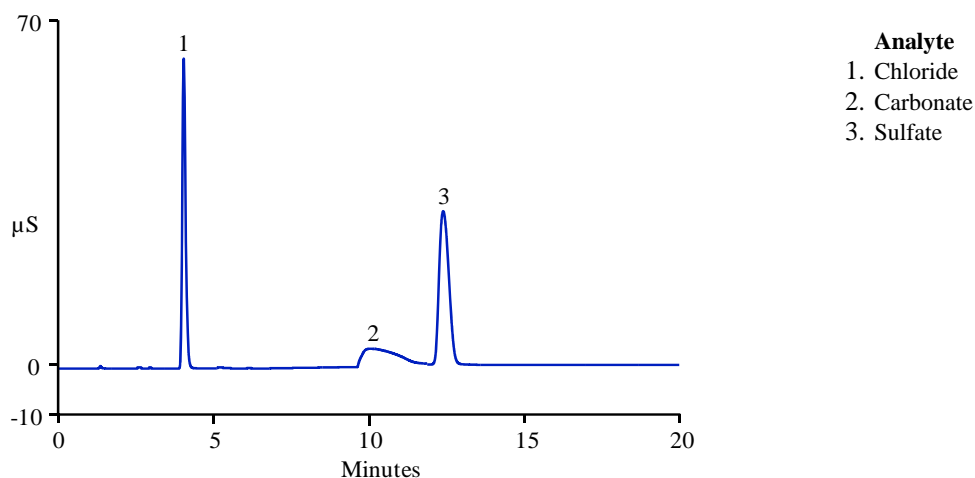

Figure 12
Sulfur Species Analysis of a Simulated Acid-Gas Scrubber Solution
Using the Dionex IonPac AS25 Column

5.8. Fast Isocratic Separation Using the Dionex IonPac AS25 Column

The examples below compare different flow rates on the Dionex IonPac AS25. At an increased flow rate of 2.0 mL/min using an isocratic hydroxide eluent, common anions and sulfur species can be eluted in less than 13 minutes.

Sample Volume:	10 μ L		
Column:	Dionex IonPac AG25/AS25 4 mm		
Eluent:	36 mM KOH		
Eluent Flow Rate:	A) 1.0 mL/min	Analyte	mg/L
	B) 1.5 mL/min	1. Fluoride	2
	C) 2.0 mL/min	2. Chloride	3
Operating Temperature:	30°C	3. Sulfate	5
Detection:	Suppressed Conductivity, Dionex ASRS 300, 4 mm	4. Iodide	20
	AutoSuppression, recycle mode	5. Thiocyanate	20
		6. Thiosulfate	10

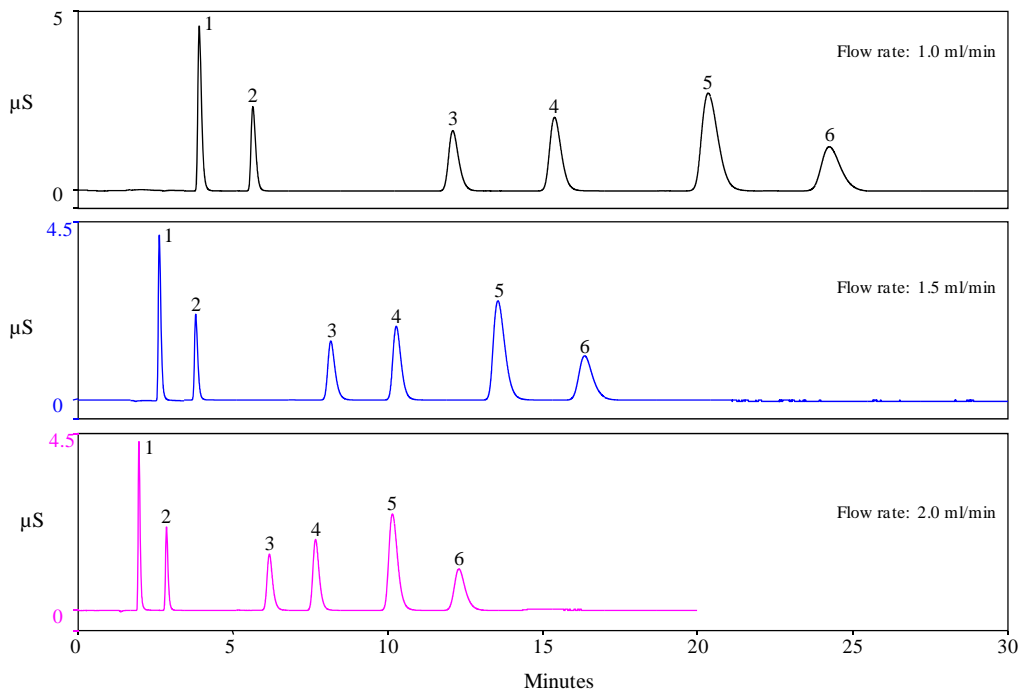

Figure 13
Fast Isocratic separation using the Dionex IonPac AS25 Column

5.9. Artificial Sample of Volcanic Gas Condensate Separated on the Dionex IonPac AS25

Volcanic gases are typically collected in a concentrated sodium hydroxide solution. This is the analysis of a simulated volcanic gas sample. The matrix is 100 mg/L of carbonate and 10 mg/L of sulfate in 5 mM sodium hydroxide. The sample was then spiked with 50 ug/L of fluoride, chloride, bromide, sulfite and 1 mg/L of iodide, thiocyanate, thiosulfate and phosphate.

Column: Dionex IonPac AG25, AS25, 2 mm
Eluent: 37 mM KOH
Eluent Source: Dionex EGC KOH Cartridge
Flow Rate: 0.25 mL/min
Inj. Volume: 6 μ L
Temperature: 30 $^{\circ}$ C
Detection: Suppressed conductivity, Dionex ASRS™ 300, AutoSuppression, recycle mode

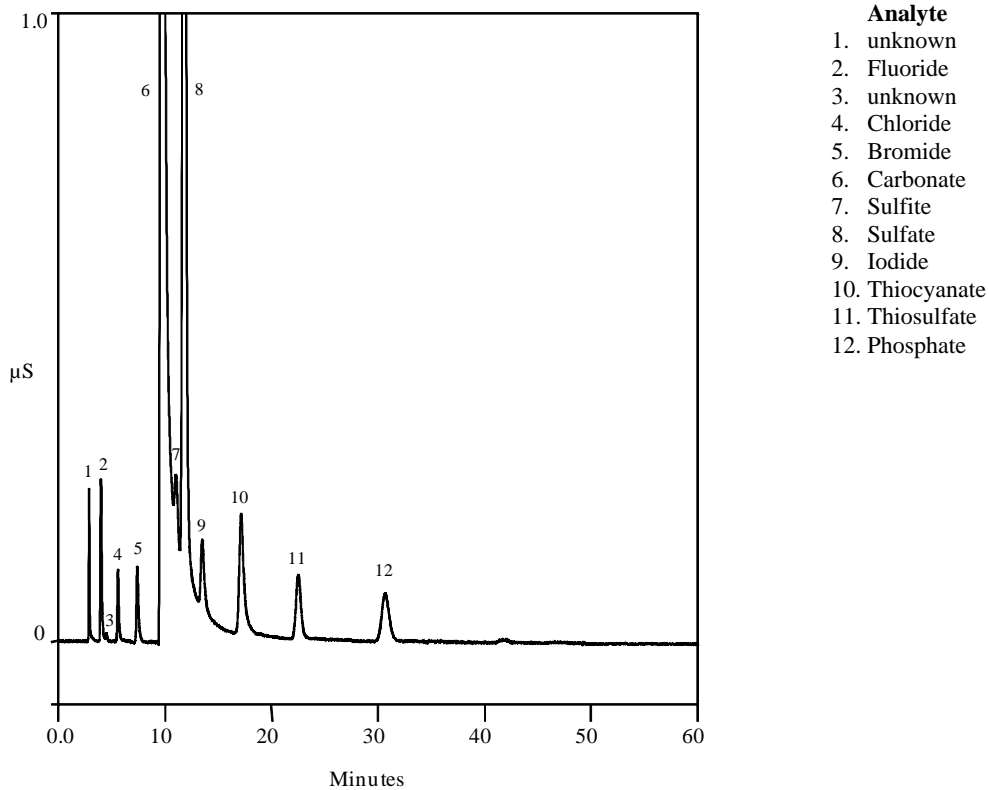

Figure 14
Artificial Sample of Volcanic Gas Condensate Separated on the Dionex IonPac AS25

5.10. Analysis of Anions Using the Dionex IonPac AS25 Capillary Column

Column: Dionex IonPac AS25 (0.4 mm x 250 mm)
Eluent Source: Dionex Capillary EGC-KOH cartridge
Eluent: 36 mM KOH
Flow Rate: 10 $\mu\text{L}/\text{min}$
Temperature: 30 $^{\circ}\text{C}$
Detection: Suppressed conductivity, Dionex ACES 300, AutoSuppression, recycle mode
Injection Volume: 0.4 μL

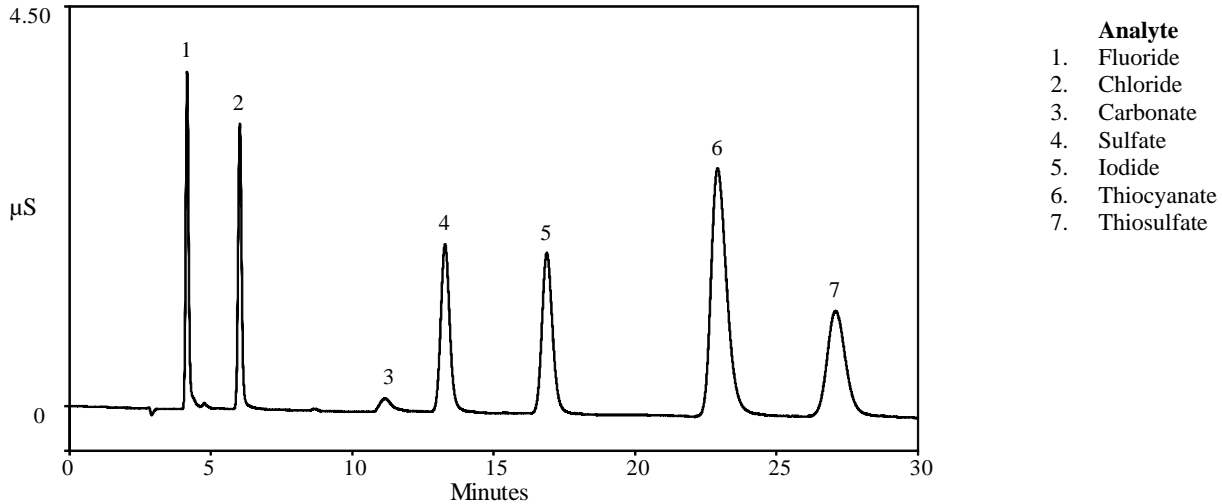

Figure 15
Analysis of Anions Using the Dionex IonPac AS25 Capillary Column

SECTION 6 – TROUBLESHOOTING GUIDE

The purpose of the Troubleshooting Guide is to help you solve operating problems that may arise while using Dionex IonPac AS25 columns. For more information on problems that originate with the Ion Chromatograph (IC) or the suppressor, refer to the Troubleshooting Guide in the appropriate operator's manual. **For assistance, contact Technical Support for Dionex Products. In the U.S., call 1-800-346-6390. Outside the U.S., call the nearest Thermo Fisher Scientific office.**

Table 7
Dionex IonPac AS25/AG25 Troubleshooting Summary

Observation	Cause	Action	Reference Section
High Back Pressure	Unknown	Isolate Blocked Component	6.1.1
	Plugged Column Bed Supports	Replace Bed Supports, Filter Eluents, and Filter Samples	6.1.2, 6.1.3, 6.1.4
	Other System Components	Unplug, Replace	Component Manual
High Background Conductivity	Contaminated Eluents	Remake Eluents	6.2, 6.2.1
	Contaminated Trap Column	Clean Trap Column	6.2.2, 6.2.3, Component Manual
	Contaminated Guard or Analyte Column	Clean Guard and Analytical Column	6.2.4
	Contaminated Dionex ASRS, ACES or AMMS	Clean Suppressor	6.2.6, Component Manual
	Contaminated Hardware	Clean Component	6.2.5, Component Manual
Poor Resolution	Poor Efficiency Due to Large System Void Volumes	Replumb System	6.3.1.2
	Column Headspace	Replace Column	6.3.1.1
Short Retention Times	Flow Rate Too fast	Recalibrate Pump	6.3.2.1
	Conc. Incorrect Eluents	Remake Eluents	6.3.2.2
	Column Contamination	Clean Column	6.3.2.3
Poor Front End	Conc. Incorrect Eluents	Remake Eluents	6.3.3.1
Resolution	Column Overloading	Reduce Sample Size	6.3.3. 2
	Sluggish Injection Valve	Service Valve	6.3.3.3, Component Manual
	Large System Void Volumes	Replumb System	6.3.3.4, Component Manual
Spurious Peaks	Sample Contaminated	Pretreat Samples	6.3.4.1
	Sluggish Injection Valve	Service Valve	6.3.4.2

6.1. High Back Pressure

6.1.1. Finding the Source of High System Pressure

Total system pressure for the Dionex IonPac AG25 (4 mm) Guard Column plus the Dionex IonPac AS25 (4 mm) Analytical Column when using the test chromatogram conditions should be equal or less than 2,100 psi. If the system pressure is higher than 2,100 psi, determine the cause of the high system pressure. The system should be operated with a Dionex High-Pressure In-Line Filter (P/N 044105) which is positioned between the gradient pump pressure transducer and the injection valve. Make sure you have one in place and that it is not contaminated. The maximum flow rate is 2 mL/min and the maximum pressure is 3,000 psi (20.68 MPa).

- A. Ensure that the pump is set to the correct eluent flow rate. Higher than recommended eluent flow rates will cause higher pressure. Measure the pump flow rate if necessary with a stop watch and graduated cylinder.
- B. Determine which part of the system is causing the high pressure. High pressure could be due to a plugged tubing or tubing with collapsed walls, an injection valve with a clogged port, a column with particulates clogging the bed support, a clogged Dionex High-Pressure In-Line Filter, the suppressor or the detector cell.

To determine which part of the chromatographic system is causing the problem, disconnect the pump eluent line from the injection valve and turn the pump on. Watch the pressure; it should not exceed 50 psi. Continue adding system components (injection valve, column(s), suppressor and detector) one by one, while monitoring the system pressure. The pressure should increase up to a maximum when the Guard and Analytical/Capillary columns are connected (see Table 8, "Typical Dionex IonPac AS25/AG25 Operating Back Pressures").

The Dionex Anion Self-Regenerating Suppressor 300 may add up to 100 psi (0.69 MPa). No other components should add more than 100 psi (0.69 MPa) of pressure. Refer to the appropriate manual for cleanup or replacement of the problem component.

Table 8
Typical Dionex IonPacAS25/AG25 Operating Back Pressures

Column	Typical Back Pressure psi (MPa)	Flow Rate mL/min
Dionex IonPac AS25 4 mm Analytical	< 1800 (12.41)	1.0
Dionex IonPac AG25 4 mm Guard	< 300 (2.07)	1.0
Dionex IonPac AS25 + AG25 4 mm columns	< 2100 (14.48)	1.0
Dionex IonPac AS25 2 mm Analytical	< 1800 (12.41)	0.25
Dionex IonPac AG25 2 mm Guard	< 300 (2.07)	0.25
Dionex IonPac AS25 + AG25 2 mm columns	< 2100 (14.48)	0.25
Dionex IonPac AS25 0.4 mm Capillary	< 2200 (15.17)	0.010
Dionex IonPac AG25 0.4 mm Capillary Guard	< 300 (2.07)	0.010
Dionex IonPac AS25 + AG25 0.4 mm Columns	< 2500 (17.24)	0.010

6.1.2. Replacing Column Bed Support Assemblies

If the column inlet bed support is determined to be the cause of the high back pressure, it should be replaced. To change the inlet bed support assembly, refer to the following instructions, using one of the two spare inlet bed support assemblies included in the Ship Kit.

- a) Disconnect the column from the system.
- b) Carefully unscrew the inlet (top) column fitting. Use two open-end wrenches.
- c) Remove the bed support.
- d) Turn the end fitting over and tap it against a bench top or other hard, flat surface to remove the bed support and seal assembly. If the bed support must be pried out of the end fitting, use a sharp pointed object such as a pair of tweezers, but be careful that you do not scratch the walls of the end fitting.
- e) Discard the old bed support assembly.
- f) Place a new bed support assembly into the end fitting.
- g) Ensure that the end of the column tube is clean and free of any particulate matter so that it will properly seal against the bed support assembly.
- h) Use the end of the column to carefully start the bed support assembly into the end fitting.

Table 9
Product Information

Product	Dionex IonPac AS25 4 mm Columns (P/N)	Dionex IonPac AS25 2 mm Columns (P/N)	Dionex IonPac AS25 0.4 mm Columns (P/N)
Analytical Column	063148	063065	075399
Guard Column	063154	063066	075400
Bed Support Assembly	042955	044689	N/A
End Fitting	052809	043278	N/A



CAUTION

If the column tube end is not clean when inserted into the end fitting, particulate matter may obstruct a proper seal between the end of the column tube and the bed support assembly. If this is the case, additional tightening may not seal the column but instead damage the column tube or the end fitting.

- i) Screw the end fitting back onto the column. Tighten it finger tight, then an additional 1/4 turn (20 in. lb. for the 4 mm, 10 in.oz. for the 2 mm). Tighten further only if leaks are observed.
- j) Reconnect the column to the system
- k) Resume operation.



NOTE

Replace the outlet bed support ONLY if high pressure persists after replacement of the inlet fitting.

6.1.3. Filter Eluent

Eluents containing particulate material or bacteria may clog the column inlet bed support. Filter water used for eluents through a 0.45 µm filter.

6.1.4. Filter Samples

Samples containing particulate material may clog the column inlet bed support. Filter samples through a 0.45 µm filter prior to injection.

6.2. High Background or Noise

In a properly working system, the background conductivity level for the standard eluent system is shown below:

Table 10
Background Conductivity

Eluent	Expected Background Conductivity
36 mM NaOH (Bottle Eluent)	< 3 µS
36 mM EGC III KOH	< 1.0 µS

6.2.1. Preparation of Eluents

- Check the eluents and the regenerant (if used) are made correctly; specifically, check that eluents were made from chemicals with the recommended purity.
- Ensure the deionized water, used to prepare the reagents, has a specific resistance of 18.2 megohm-cm.

6.2.2. A Contaminated Trap Column

High background may be caused by contamination of the Dionex ATC-HC or Dionex ATC-3 with carbonate or other anions from the eluent.

- Clean the Dionex ATC-HC or Dionex ATC-3 (4 mm) with 100 mL of 2.0 M NaOH or 50 mL for the Dionex ATC-3 (2 mm).
- Rinse the Dionex ATC-HC or Dionex ATC-3 (4 mm) immediately with 20 mL of eluent or 10 mL of eluent for the Dionex ATC-3 (2 mm) into a beaker prior to use.

6.2.3. Contaminated Dionex CR-ATC Column

- Install a Dionex CR-ATC Anion Trap Column (P/N 060477 or 072078) if using a Dionex Eluent Generator with Dionex EGC KOH cartridge.
- If the Dionex CR-ATC becomes contaminated, please refer to Section 6, Clean-Up, in the Dionex CR-ATC Product Manual (Document No. 031910).

6.2.4. A Contaminated Guard or Analytical Column

- Remove the Dionex IonPac AG25 Guard and Dionex IonPac AS25 Analytical/Capillary Columns from the system.
- Install a back pressure coil that generates approximately 1,500 psi and continue to pump eluent. If the background conductivity decreases, the column(s) is (are) the cause of the high background conductivity.
- To eliminate downtime, clean or replace the Dionex IonPac AG25 at the first sign of column performance degradation. Clean the column as instructed in, "Column Cleanup" (See Appendix A "Column Care").

6.2.5. Contaminated Hardware

Eliminate the hardware as the source of the high background conductivity.

- a) Bypass the columns and the suppressor.
- b) Install a back pressure coil that generates approximately 1,500 psi and continue to pump eluent.
- c) Pump deionized water with a specific resistance of 18.2 megohm-cm through the system.
- d) The background conductivity should be less than 2 μ S. If it is not, check the detector/conductivity cell calibration by injecting deionized water directly into it. See the appropriate manual for details.

6.2.6. A Contaminated Dionex ASRS 300, Dionex ACES 300 or Dionex AMMS 300 Suppressor

If the above items have been checked and the problem persists, the Dionex Anion Self-Regenerating Suppressor, the Dionex Anion Capillary Electrolytic Suppressor or the Dionex Anion MicroMembrane Suppressor is probably causing the problem. For details on Dionex Anion Self-Regenerating Suppressor operation, refer to the Dionex Anion Self-Regenerating Suppressor 300 Product Manual (Document No. 031956). For details on Dionex Anion Membrane Suppressor 300 operation, refer to the Product Manual (Document No. 031727) for assistance. For details on the Dionex Anion Capillary Electrolytic Suppressor 300 (Dionex ACES 300) operation, refer to the product manual (Document No. 065388) for assistance.

- a) Check the power level and alarms on the Dionex SRS Control.
- b) Check the regenerant flow rate at the REGEN OUT port of the Dionex ASRS if operating in the AutoSuppression External Waster mode or the Chemical Suppression mode or the Dionex AMMS.
- c) Check the eluent flow rate.
- d) If you are using a Dionex AutoRegen accessory with the Dionex ASRS in the Chemical Suppression Mode or the Dionex AMMS, prepare fresh regenerant solution.
- e) Test both the suppressor and the Dionex AutoRegen Regenerant Cartridge for contamination. If the background conductivity is high after preparing fresh regenerant and bypassing the Dionex AutoRegen Regenerant Cartridge, you probably need to clean or replace your Dionex ASRS, Dionex ACES or Dionex AMMS.

If the background conductivity is low when freshly prepared regenerant is run through the Dionex ASRS or Dionex AMMS without an AutoRegen accessory in-line, test the Dionex AutoRegen Regenerant Cartridge to see if it is expended.

- a) Connect the freshly prepared regenerant to the Dionex AutoRegen Regenerant Cartridge.
- b) Pump approximately 200 mL of regenerant through the Dionex AutoRegen Regenerant Cartridge to waste before recycling the regenerant back to the regenerant reservoir. If the background conductivity is high after placing the Dionex AutoRegen accessory in-line, you probably need to replace the Dionex AutoRegen Regenerant Cartridge. Refer to the "Dionex AutoRegen Regenerant Cartridge Refill Product Manual" (Document No. 032852) for assistance.

6.3. Poor Peak Resolution

Poor peak resolution can be due to any or all of the following factors.

6.3.1. Loss of Column Efficiency

6.3.1.1. Peak Fronting:

- a) Check to see if headspace has developed in the guard or analytical column. This is usually due to improper use of the column such as submitting it to high pressures.
- b) Remove the column's top end fitting (see Section 6.1.2, "Replacing Column Bed Support Assemblies"). If the resin does not fill the column body all the way to the top, it means that the resin bed has collapsed, creating a headspace. The column must be replaced.

6.3.1.2. Symmetric Inefficient Peaks:

Extra-column effects can result in sample band dispersion, making the peaks' elution less efficient.

- a) Ensure you are using PEEK tubing with an ID of no greater than 0.010" for 4 mm systems or greater than 0.005" for 2 mm systems.
- b) Check all eluent liquid line connections between the injection valve and the detector cell inlet.
- c) Cut the tubing lengths as short as possible.
- d) Check for leaks.

6.3.2. Poor Resolution Due to Shortened Retention Times



Even with adequate system and column efficiency, resolution of peaks will be compromised if analytes elute too fast.

NOTE

6.3.2.1. Flow Rate:

- a) Check the flow rate to see if the eluent flow rate is equivalent to the flow rate specified by the analytical protocol.
- b) Measure the eluent flow rate after the column using a stopwatch and graduated cylinder.

6.3.2.2. Compositions and Concentrations:

- a) Check to see if the eluent compositions and concentrations are correct. An eluent that is too concentrated will cause the peaks to elute faster.
- b) Prepare fresh eluent.



If you are using a gradient pump to proportion the eluent, or components from two or three different eluent reservoirs, the resulting eluent composition may not be accurate enough for the application. This may be a problem when one of the proportioned eluents is less than 5%.

NOTE

- c) Use one reservoir containing the correct eluent composition.

6.3.2.3. Column Contamination:

Column contamination can lead to a loss of column capacity. This is because all of the anion exchange sites will no longer be available for the sample ions. For example, polyvalent anions from the sample or metals may concentrate on the column. Refer to, "Column Cleanup" (see Appendix A "Column Care"), for recommended column cleanup procedures.



Possible sources of column contamination are impurities in chemicals and in the deionized water used for eluents or components of the sample matrix. Be especially careful to make sure that the recommended chemicals are used. The deionized water should have a specific resistance of 18.2 megohm-cm.

NOTE

6.3.2.4. Diluting the Eluent:

Diluting the eluent will improve peak resolution, but will also increase the analytes' retention times. If a 10% dilution of the eluent is not sufficient to obtain the desired peak resolution, or if the resulting increase in retention times is unacceptable, clean the column (see, "Column Cleanup" in Appendix A "Column Care").

- a) After cleaning the column, reinstall it in the system.
- b) Let the column equilibrate with eluent for about 30 minutes.

No water wash is necessary. The column is equilibrated when consecutive injections of the standard give reproducible retention times. The original column capacity should be restored by this treatment, since the contaminants should be eluted from the column. For assistance, contact Technical Support for Dionex Products. In the U.S., call 1-800-346-6390. Outside the U.S., call the nearest Thermo Fisher Scientific office.

6.3.3. Loss of Front End Resolution

If poor resolution or efficiency is observed for the peaks eluting near the system void volume compared to the later eluting peaks, check the following:

6.3.3.1. Improper Eluent Concentration

- a) Remake the eluent as required for your application.
- b) Ensure that the water and chemicals used are of the required purity.

6.3.3.2. Column Overloading

- a) Reduce the amount of sample ions being injected onto the analytical/capillary column by either diluting the sample or injecting a smaller volume onto the column.

6.3.3.3. Sluggish Operation of the Injection Valve

- a) Check the air pressure.
- b) Ensure there are no gas leaks.
- c) Check that the port faces are not partially plugged. Refer to the valve manual for instructions.

6.3.3.4. Improperly Swept Out Volumes

- a) Swap components, one at a time, in the system prior to the analytical/capillary column and test for front-end resolution after every system change. Remember to use the shortest tubing lengths possible.

6.3.4. Spurious Peaks

6.3.4.1. Contaminated Columns

If the samples contain an appreciable level of polyvalent ions and the column is used with a weak eluent system, the retention times for the analytes will then decrease and become spurious, inefficient (broad) peaks that can show up at unexpected times.

- a) Clean the column as indicated in "Column Cleanup" (see Appendix A "Column Care").



NOTE

If you need assistance in determining the best way to clean strongly retained solutes in your specific sample matrix from the Dionex IonPac AS25 column, contact Technical Support for Dionex Products. In the U.S., call 1-800-346-6390. Outside the U.S., call the nearest Thermo Fisher Scientific office.

6.3.4.2. Injection Valve May Require Maintenance

When an injection valve is actuated, the possibility of creating a baseline disturbance exists. This baseline upset can show up as a peak of varying size and shape. This will occur when the injection valve needs to be cleaned or retorqued. (see valve manual).

- Check to see that there are no restrictions in the tubing connected to the valve.
- Check the valve port faces for blockage and replace them if necessary. Refer to the Valve Manual for troubleshooting and service procedures.

Small baseline disturbances at the beginning or at the end of the chromatogram can be overlooked as long as they do not interfere with the quantification of the peaks of interest.

6.3.5. Poor Efficiency Using Capillary Columns

Incorrectly installed fittings on capillary tubing can increase void volumes, causing chromatograms with tailing peaks.

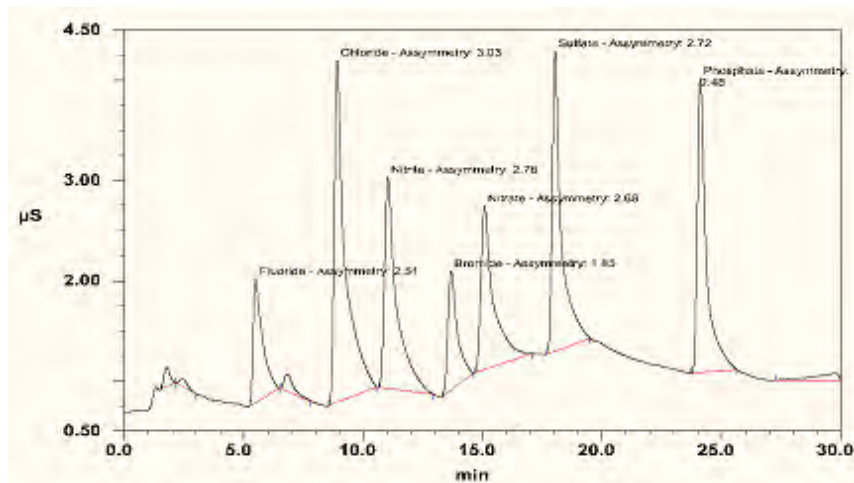

Figure 16
Tailing Peaks Caused by Incorrectly Installed
Capillary Tubing Fittings

When connecting a capillary tube fitting, make sure that the ferrule and fitting bolt are at least 2 mm (0.1 in) from the end of the tubing before you insert the tubing into the port. Do not place the ferrule and fitting bolt flush with the end of the tubing. Figure 17 illustrates the correct and incorrect placement of the ferrule and fitting bolt on the tubing.

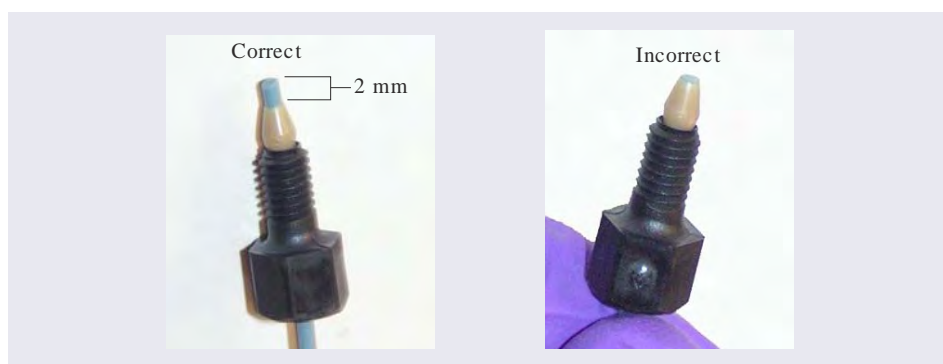

Figure 17
Correct and Incorrect Ferrule and
Fitting Bolt Placement for Capillary Tubing Connections

APPENDIX A – COLUMN CARE

A.1 Recommended Operating Pressure

Operating a column above its recommended pressure limit can cause irreversible loss of column performance. The maximum recommended operating pressure for Dionex IonPac AS25 columns is 3,000 psi (20.68 MPa).

A.2 Column Start-Up

The column is shipped using the column test eluent as the storage solution.

Prepare the eluent shown on the test chromatogram, install the column in the chromatography module and test the column performance under the conditions described in the test chromatogram. Continue making injections of the test standard until consecutive injections of the standard give reproducible retention times. Equilibration is complete when consecutive injections of the standard give reproducible retention times.

A.3 Column Storage

For short-term storage (< 1 week), use Eluent, for long-term storage (> 1 week), use 100 mM Sodium Borate for the column storage solution. Flush the column for a minimum of 10 minutes with the storage solution. Cap both ends securely, using the plugs supplied with the column.

A.4 Column Cleanup

The following column cleanup protocols have been divided into three general isocratic protocols to remove acid-soluble, base-soluble, or organic contaminants. They can be combined into one gradient protocol if desired; however, the following precautions should be observed.



WARNING

- *Always ensure that the cleanup protocol used does not switch between eluents which may create high pressure eluent interface zones in the column.*
- *High pressure zones can disrupt the uniformity of the packing of the column bed and irreversibly damage the performance of the column.*
- *High pressure zones in the column can be created by pumping successive eluents through the column that are not miscible, that have eluent components in one eluent that will precipitate out in the other eluent or by using an acid eluent followed by a base eluent which may create a neutralization pressure band.*
- *The precipitation of the salts in solvents during column rinses can result in very high pressure zones. High viscosity mixing zones can be created between two eluents having solvents with a very high energy of mixing.*

When in doubt, always include short column rinse steps to reduce the solvent content of the eluent to < 5% levels and the ionic strength of the eluent to < 50 mM levels to avoid creating high pressure zones in the column that may disrupt the uniformity of the column packing.

A.4.1 Choosing the Appropriate Cleanup Solution

Contamination	Solution
Hydrophilic Contamination of Low Valence	Concentrated hydroxide solutions such as a 10X concentrate of the most concentrated eluent used in the application is sufficient to remove hydrophilic contamination of low valence.
High Valence Hydrophilic Ions Contamination	Concentrated acid solutions such as 1 to 3 M HCl will remove high valence hydrophilic ions by ion suppression and elution by the chloride ion.
Metal Contamination	Metal contamination often results in asymmetric peak shapes and/or variable analyte recoveries. For example, iron or aluminum contamination often results in tailing of sulfate and phosphate. Aluminum contamination can also result in low phosphate recoveries.
	Concentrated acid solutions such as 1 to 3 M HCl remove a variety of metals. If after acid treatment, the chromatography still suggests metal contamination, treatment with chelating acids such as 0.2 M oxalic acid is recommended.
Nonionic and Hydrophobic Contamination	Organic solvents can be used alone if the contamination is nonionic and hydrophobic. The degree of nonpolar character of the solvent should be increased as the degree of hydrophobicity of the contamination within the range of acceptable solvents.
Ionic and Hydrophobic Contamination	Concentrated acid solutions such as 1 to 3 M HCl can be used with compatible organic solvents to remove contamination that is ionic and hydrophobic. The acid suppresses ionization and ion exchange interactions of the contamination with the resin.
	A frequently used cleanup solution is 200 mM HCl in 80% acetonitrile. This solution must be made immediately before use because the acetonitrile will decompose in the acid solution during long term storage.

A.4.2 Column Cleanup Procedure

Use the following cleanup procedures to clean the Dionex IonPac AG25 and Dionex IonPac AS25.

- Prepare a 500 mL solution of the appropriate cleanup solution using the guidelines in, "Choosing the Appropriate Cleanup Solution".
- Disconnect the Dionex ASRS 300, Dionex ACES 300 or Dionex AMMS 300 from the Dionex IonPac AS25 Analytical/Capillary Column.
- If your system is configured with both a guard column and an analytical/capillary column, reverse the order of the guard and analytical/capillary column in the eluent flow path.
- Double check that the eluent flows in the direction designated on each of the column labels.



CAUTION

When cleaning an analytical column and a guard column (or capillary and capillary guard) in series, ensure that the guard column is placed after the analytical/capillary column in the eluent flow path. If not, the contaminants that have accumulated on the guard column can be eluted onto the analytical/capillary column and irreversibly damage it. If in doubt, clean each column separately.

- Set the pump flow rate to 1.0 mL/min for an Dionex IonPac AS25 4 mm Analytical or Guard Column or set the pump flow rate to 0.25 mL/min for a Dionex IonPac AS25 2 mm Analytical or Guard Column. Set the pump flow rate to 0.010 mL/min for a Dionex IonPac AS25 Capillary or Capillary Guard Column.
- Rinse the column for 10 minutes with deionized water before pumping the chosen cleanup solution over the column.
- Pump the cleanup solution through the column for at least 60 minutes.
- Rinse the column for 10 minutes with deionized water before pumping eluent over the column.
- Equilibrate the column(s) with eluent for at least 60 minutes before resuming normal operation.
- Reconnect the Dionex ASRS 300, Dionex ACES 300 or Dionex AMMS 300 to the Dionex IonPac AS25 Analytical or Capillary Column

Place the guard column in line between the injection valve and the analytical or capillary column if your system was originally configured with a guard column.

APPENDIX B – CONFIGURATION

Table B1
Configuration

CONFIGURATION	2 mm	4 mm	0.4 mm
Eluent Flow Rate	0.25 mL/min	1.0 µL/min	0.010 µL/min
SRS Suppressor	Dionex ASRS 300 (P/N 061562)	Dionex ASRS 300 (P/N 061561)	N/A
MMS Suppressor	Dionex AMMS 300 (P/N 056751)	Dionex AMMS 300 (P/N 056750)	N/A
ACES Suppressor	N/A	N/A	Dionex ACES 300 (P/N 072052)
NOTE: <i>Do not run suppressors over 40°C. If application requires a higher temperature, place suppressor outside of chromatographic oven.</i>			
Injection Loop	2 - 15 µL Use the Rheodyne Microinjection Valve, Model No. 9126 P/N 044697) for full loop injections <15 µL.	10 - 50 µL	0.4 µL (typical)
System Void Volume	Eliminate switching valves, couplers and the Dionex GM-3 Gradient Mixer. Use only the 2 mm Dionex GM-4 Mixer (P/N 049135).	Minimize dead volumes. Switching valves, couplers can be used. Use the Dionex GM-2, GM-3 or recommended gradient mixers.	Use only in an IC system equipped for capillary analysis.
Pumps	Use the Dionex ICS 2100/5000, or Dionex GS50/GP50/GP40/IP20/IP25 in Microbore Configuration with a Microbore Dionex GM-4 (2 mm) Gradient Mixer. The Dionex GPM-2 can be used for 2 mm isocratic chromatography at flow rates of 0.5 mL/min or greater but cannot be used for 2 mm gradient chromatography	Use the Dionex ICS 2100/5000, or Dionex GP40/GP50/IP20/IP25 in Standard-Bore Configuration. The Dionex GM-3 Gradient Mixer should be used for gradient analysis on systems other than the Dionex GP50. The Dionex GP40 has an active mixer.	Use only a pump designed for capillary flow rates such as the Dionex ICS-5000 capillary pump.
NOTE: <i>Use of a Dionex EGC-KOH cartridge (P/N 074532 or 072076 in conjunction with a Dionex CR-ATC P/N 060477 or 072078) for gradient applications is highly recommended for minimum baseline change when performing eluent step changes or gradients.</i>			
Chromatographic Module	A thermally controlled column oven such as the Dionex LC25,LC30,ICS-10,11,15,16,20,2100,3000,5000 DC	A thermally controlled column oven such as the Dionex LC25,LC30,ICS-10,11,15,16,20,2100,3000,5000 DC	A thermally controlled column compartment such as the Dionex ICS-5000 DC or Dionex IC-Cube.

CONFIGURATION	2 mm	4 mm	0.4 mm
Detectors	<p>Dionex Conductivity Detector P/N 061830</p> <p>Dionex AD20/AD25 Cell (6 mm, 7.5 μL, P/N 046423)</p> <p>Dionex VDM-2 Cell (3 mm, 2.0 μL) (P/N 043120)</p> <p>Dionex CD20, CD25, CD25A, ED40, ED50, or ED50A</p> <p>Dionex Conductivity Cell with Dionex DS3 P/N 044130 or Dionex Conductivity Cell with shield P/N 044132</p> <p>Dionex CDM-2/CDM-3 Cell P/N 042770</p> <p>Replace the Dionex TS-1 with the Dionex TS-2 (P/N 043117) on the Dionex CDM-2 or the Dionex CDM-3. The Dionex TS-2 has been optimized for 2 mm operation. Do not use the Dionex TS-2 or the Dionex TS-1 with the Dionex ED40/ED50/ED50A or the Dionex CD20/CD25/CD25A.</p> <p>Ensure 30–40 psi back pressure.</p>	<p>Dionex Conductivity Detector P/N 061830</p> <p>Dionex AD20/AD25 Cell (10 mm, 9 μL, P/N 049393)</p> <p>Dionex VDM-2 Cell (6 mm, 10 μL) P/N 043113</p> <p>Dionex CD20, CD25, CD25A, ED40, ED50, or ED50A</p> <p>Dionex Conductivity Cell with Dionex DS3 P/N 044130 or Dionex Conductivity Cell with shield P/N 044132</p> <p>Dionex CDM-2/CDM-3 Cell P/N 042770</p> <p>Either the Dionex TS-1 with the Dionex TS-2 can be used with the Dionex CDM-2 or the Dionex CDM-3. Do not use the Dionex TS-2 or the Dionex TS-1 with the Dionex ED40/ED50/ED50A or the Dionex CD20/CD25/CD25A.</p> <p>Ensure 30–40 psi back pressure.</p>	<p>Use only a conductivity detector designed for capillary flow rates such as the Dionex ICS-5000 Capillary CD.</p>

Table B2
Tubing Back Pressures

Color	Part Number	I.D. inch	I.D. cm	Volume mL/ft	Back Pressure Psi/ft. at 1 mL/min	Back Pressure Psi/ft. at 0.25 mL/min	Back Pressure Psi/cm. at 1 mL/min
Green	044777	0.030	0.076	0.137	0.086	0.021	0.003
Orange	042855	0.020	0.051	0.061	0.435	0.109	0.015
Blue	049714	0.013	0.033	0.026	2.437	0.609	0.081
Black	042690	0.010	0.025	0.015	6.960	1.740	0.232
Red	044221	0.005	0.013	0.004	111.360	27.840	3.712
Yellow	049715	0.003	0.008	0.001	859.259	214.815	28.642
Light Blue	071870	0.0025	0.006	0.0009	1766.0	441.0	58.0

ATTACHMENT A – DIONEX IONPAC AS25 ANALYTICAL, 2X250 MM

**Dionex IonPac® AS25 2-mm
Analytical (2 x 250 mm)
Product No. 076016**

Eluent: 36 mM KOH
Eluent Source: Dionex EGC II KOH Cartridge
Flow Rate: 0.25 mL/min
Temperature: 30 °C
Detection: Suppressed Conductivity
Suppressor: Dionex Anion Self-Regenerating Suppressor (ASRS® 300 2-mm)
 Dionex AutoSuppression® Recycle Mode
Applied Current: 23 mA
Injection Volume: 2.5 µL
Storage Solution: 100 mM Sodium Tetraborate

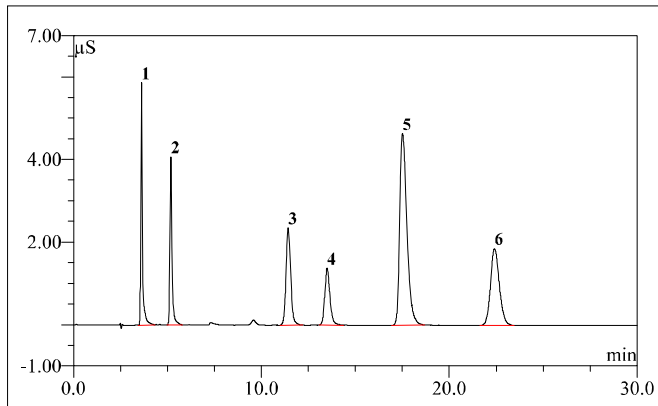

No.	Peak Name	Ret.Time (min)	Asymmetry (AIA)	Resolution (EP)	Efficiency (EP)	Concentration (mg/L)
1	Fluoride	3.62	1.6	9.60	10289	2.0
2	Chloride	5.19	1.4	20.00	12621	3.0
3	Sulfate	11.43	1.2	4.49	10727	5.0
4	Iodide	13.51	1.3	6.94	12428	20.0
5	Thiocyanate	17.52	1.8	6.44	10785	20.0
6	Thiosulfate	22.41	1.3	n.a.	11144	10.0

QA Results:

Analyte	Parameter	Specification	Results
Sulfate	Efficiency	>=5850	Passed
Sulfate	Asymmetry	1.0-2.2	Passed
Sulfate	Retention Time	10.88-13.63	Passed
	Pressure	<=1980	907

Production Reference:

Datasource: QAR
 Directory: Anion\AS25
 Sequence: AS25_2X250MM
 Sample No.: 1

ATTACHMENT B – DIONEX IONPAC AS25 ANALYTICAL, 4X250 MM

**Dionex IonPac® AS25
Analytical (4 x 250 mm)
Product No. 076014**

Eluent: 36 mM KOH
Eluent Source: Dionex EGC II KOH Cartridge
Flow Rate: 1.0 mL/min
Temperature: 30 °C
Detection: Suppressed Conductivity
Suppressor: Dionex Anion Self-Regenerating Suppressor (ASRS® 300 4-mm)
 Dionex AutoSuppression® Recycle Mode
Applied Current: 92 mA
Injection Volume: 10 µL
Storage Solution: 100 mM Sodium Tetraborate

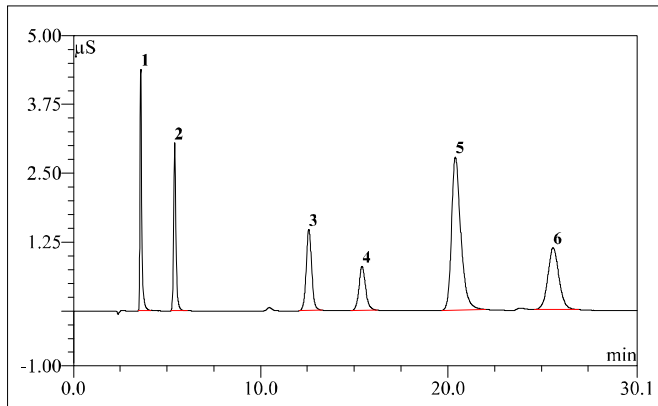

No.	Peak Name	Ret.Time (min)	Asymmetry (AIA)	Resolution (EP)	Efficiency (EP)	Concentration (mg/L)
1	Fluoride	3.59	1.7	10.11	8865	2.0
2	Chloride	5.40	1.5	19.90	10957	3.0
3	Sulfate	12.57	1.1	4.99	9498	5.0
4	Iodide	15.42	1.2	6.66	9697	20.0
5	Thiocyanate	20.40	1.6	5.43	8713	20.0
6	Thiosulfate	25.63	1.1	n.a.	9424	10.0

QA Results:

Analyte	Parameter	Specification	Results
Sulfate	Efficiency	>=5850	Passed
Sulfate	Asymmetry	1.0-2.2	Passed
Sulfate	Retention Time	10.88-13.63	Passed
	Pressure	<=1980	1356

Production Reference:

Datasource: QAR
 Directory: Anion\AS25
 Sequence: AS25_4X250MM
 Sample No.: 1

ATTACHMENT C – DIONEX IONPAC AS25 CAPILLARY, 0.4X250 MM

**Dionex IonPac® AS25
Capillary (0.4 x 250 mm)
Product No. 076012**

Eluent: 36 mM KOH
Eluent Source: Dionex EGC-KOH Capillary
Flow Rate: 0.010 mL/min
Temperature: 30 °C
Detection: Suppressed Conductivity
Suppressor: Dionex Anion Capillary Electrolytic Suppressor (ACES 300)
 Dionex AutoSuppression® Recycle Mode
Applied Current: 10 mA
Injection Volume: 400 nL
Storage Solution: 100 mM Sodium Tetraborate

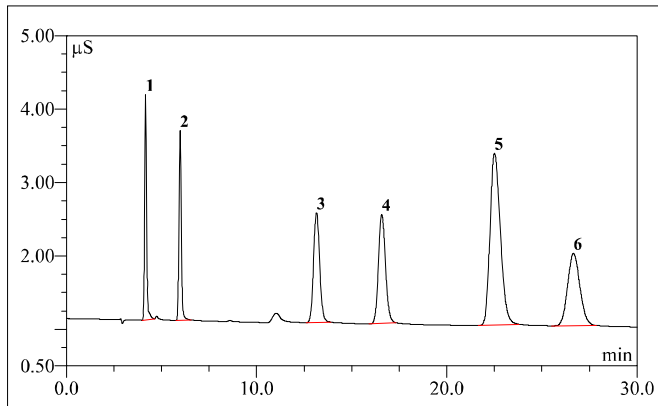

No.	Peak Name	Ret.Time (min)	Asymmetry (AIA)	Resolution (EP)	Efficiency (EP)	Concentration (mg/L)
1	Fluoride	4.16	1.2	8.86	8220	0.4
2	Chloride	5.98	1.1	17.54	11048	1.0
3	Sulfate	13.15	1.1	5.41	7880	2.0
4	Iodide	16.58	1.2	7.08	9534	4.0
5	Thiocyanate	22.51	1.4	3.80	8130	4.0
6	Thiosulfate	26.66	1.2	n.a.	8015	6.0

QA Results:

Analyte	Parameter	Specification	Results
Sulfate	Efficiency	>=5850	Passed
Sulfate	Asymmetry	1.0-2.2	Passed
Sulfate	Retention Time	10.88-13.63	Passed
	Pressure	<=1980	1270

Production Reference:

Datasource: QAR
 Directory: Cap\AS25
 Sequence: AS25_0p4X250MM
 Sample No.: 1