

Errata

Product Manual for Dionex IonPac™ AS20 and AG20 Columns
065044-05

For new orders of the following parts discussed in this manual, please use the updated part numbers listed below.

Part	Old Part Number in this manual	Updated Part Number to use for new orders
<i>PROD,COL,IP,ATC-3,4X35MM</i>	<i>059661</i>	<i>079932</i>
<i>PROD,COL,IP,UTAC-LP2,4X35MM</i>	<i>072779</i>	<i>079917</i>
<i>PROD,COL,IP,UTAC-ULP2,5X23MM</i>	<i>072780</i>	<i>079918</i>



Thermo Scientific

Dionex IonPac AS20 Columns

Product Manual

P/N: 065044-05 June 2012

Product Manual

for

IonPac[®] AG20 Guard Column

4x50 mm (P/N 063154)

2x50 mm (P/N 063066)

0.4x50 mm (PN: 075400)

IonPac[®] AS20 Analytical Column

4x250 mm (P/N 063148)

2x250 mm (P/N 063065)

0.4x250 mm (PN 075399)

© 2012 Thermo Fisher Scientific

Document No. 065044

Revision 05

June 2012

TABLE OF CONTENTS

SECTION 1 – INTRODUCTION.....	4
SECTION 2 – ION CHROMATOGRAPHY SYSTEMS.....	6
SECTION 3 – INSTALLATION.....	7
3.1. System Requirements	7
3.1.1. System Requirements for 0.4 mm Operation.....	7
3.1.2. System Requirements for 2-mm Operation	7
3.1.3. System Requirements for 4-mm Operation	7
3.1.4. System Void Volume.....	7
3.2. The Sample Concentrator	7
3.3. The Injection Loop	8
3.3.1. The 2-mm System Injection Loop, 2 - 15 μ L	8
3.3.2. The 4-mm System Injection Loop, 10 - 50 μ L	8
3.3.3. The 0.4-mm System Injection Loop, 0.4 μ L Internal Loop	8
3.4. The IonPac AG20 Guard Column	8
3.5. CR-ATC Trap Column Installation with EGC	9
3.6. Eluent Storage	9
3.7. Anion Self-Regenerating Suppressor Requirements	9
3.8. Anion MicroMembrane Suppressor Requirements	9
3.9. Using Displacement Chemical Regeneration (DCR) in the Chemical Suppression Mode	9
3.10. Detector Requirements	10
3.11. Using the EGC-KOH with AS20.....	10
3.12. Detector Requirements	10
3.13. Installation of the Capillary Column	10
SECTION 4 – OPERATION	14
4.1. General Operating Conditions	14
4.2. IonPac AS20 Operation Precautions	14
4.3. Chemical Purity Requirements.....	14
4.3.1. Inorganic Chemicals	14
4.3.2. Deionized Water	14
4.3.3. Solvents	15
4.4. Making Eluents that Contain Solvents	16
4.5. Eluent Preparation	16
4.5.1. Sodium Hydroxide Eluent Concentration.....	16
4.6. Regenerant Preparation for the AMMS 300.....	17

SECTION 5 – EXAMPLE APPLICATIONS	18
5.1. Recommendations for Optimum System Performance	18
5.2. Production Test Chromatograms	19
5.3. Isocratic Separation of Polarizable Anions and 4 - Chlorobenzene Sulfonate	20
5.4. Isocratic Separation of Common Anions and Polarizable Anions	21
5.5. Separation of Polarizable Anions and Inorganic Anions Using Gradient Elution	22
5.6. Separation of Polyphosphate Anions Using the Eluent Generator	23
5.7. Determination of Trace Perchlorate in Drinking Water Using the AS20 Column and the Cryptand C1 Concentrator Column	24
5.8. Analysis of Anions Using the AS20 Capillary Column	26
5.9. Determination of Trace Concentrations in Bromate Using the IonPac AS20 with Two-Dimensional Ion Chromatography	27
SECTION 6 – TROUBLESHOOTING GUIDE	28
6.1. High Back Pressure	29
6.1.1. Finding the Source of High System Pressure	29
6.1.2. Replacing Column Bed Support Assemblies	30
6.1.3. Filter Eluent	31
6.1.4. Filter Samples	31
6.2. High Background or Noise	31
6.2.1. Preparation of Eluents	31
6.2.2. A Contaminated Trap Column	31
6.2.3. Contaminated CR-ATC Column	31
6.2.4. A Contaminated Guard or Analytical Column	31
6.2.5. Contaminated Hardware	32
6.2.6. A Contaminated ASRS 300, ACES 300 or AMMS 300 Suppressor	32
6.3. Poor Peak Resolution	32
6.3.1. Loss of Column Efficiency	32
6.3.2. Poor Resolution Due to Shortened Retention Times	33
6.3.3. Loss of Front End Resolution	34
6.3.4. Spurious Peaks	34
6.3.5. Poor Efficiency Using Capillary Columns	35
APPENDIX A - COLUMN CARE	36
A.1 Recommended Operating Pressure	36
A.2 Column Start-Up	36
A.3 Column Storage	36
A.4 Column Cleanup	36
A.4.1 Choosing the Appropriate Cleanup Solution	37
A.4.2 Column Cleanup Procedure	37
APPENDIX B - Configuration	38
ATTACHMENT A - IonPac AS20 2-mm Analytical 2x250 mm	40
ATTACHMENT B - IonPac AS20 4-mm Analytical 4x250 mm	41
ATTACHMENT C - IonPac AS20 4-mm Analytical 0.4x250 mm	42

SECTION 1 – INTRODUCTION

The IonPac® AS20 Analytical Column is a high capacity, hydroxide selective anion exchange column designed for the isocratic separation of polarizable anions including iodide, thiocyanate, thiosulfate, and perchlorate in a variety of sample matrices. The key application for the AS20 column is the determination of trace perchlorate in drinking water matrices.

The AS20 column has a capacity of approximately 310 µeq/column which allows large loop injections without column overloading. Under isocratic conditions, the polarizable anions can easily be separated in approximately 20 minutes. Trace concentrations of perchlorate in drinking water, surface water, and ground water matrices can easily be determined using a large loop injection. The AG20 guard column is packed with a microporous resin with a lower capacity. The microporous resin ensures optimum long term performance of the guard column.

The IonPac AS20 Capillary Column (0.4 x 250 mm) is packed with the same material as the equivalent standard bore version (producing the same performance as a 4 mm column), but requires only one-hundredth (1/100) the eluent flow rate. The capillary format has the advantage of less eluent consumption, providing reduced costs.

Table 1
IonPac AS20/AG20 Packing Specification

Column	Particle Diameter µm	Substrate X-linking %	Column Capacity µeq/column	Functional Group	Hydrophobicity
AS20* 4x250 mm	7.5	55	310	Alkanol quaternary ammonium	Ultralow
AG20** 4x50 mm	11	55	6	Alkanol quaternary ammonium	Ultralow
AS20* 2x250 mm	7.5	55	77.5	Alkanol quaternary ammonium	Ultralow
AG20** 2x50mm	11	55	1.5	Alkanol quaternary ammonium	Ultralow
AS20* 0.4 x 250 mm	7.5	55	3.1	Alkanol quaternary ammonium	Ultralow
AG20** 0.4 x 250 mm	11	55	0.06	Alkanol quaternary ammonium	Ultralow

* Analytical Column resin composition: supermacroporous polyvinylbenzyl ammonium polymer cross-linked with divinylbenzene.

** Guard Column resin composition: microporous polyvinylbenzyl

Table 2
AS20/AG20 Operating Parameters

Column	Typical Back Pressure psi (MPa)	Standard Flow Rate mL/min	Maximum Flow Rate mL/min
AS20 4-mm Analytical	< 1,800 (12.41)	1	2
AG20 4-mm Guard	< 300 (2.07)	1	2
AS20 and AG20 4-mm columns	< 2,100 (14.48)	1	2
AS20 2-mm Analytical	< 1,800 (12.41)	0.25	0.5
AG20 2-mm Guard	< 300 (2.07)	0.25	0.5
AS20 and AG20 2-mm columns	< 2,100 (14.48)	0.25	0.5
AS20 0.4-mm Capillary	< 2,200 (15.17)	0.010	0.020
AG20 0.4-mm Capillary Guard	< 300 (2.28)	0.010	0.020
AS20 and AG20 0.4-mm Capillary and Capillary Guard	< 2500 (17.45)	0.010	0.020

Assistance is available for any problem during the shipment or operation of Dionex instrumentation and columns through the Dionex North America Technical Call Center at 1-800-DIONEX-0 (1-800-346-6390) or through any of the Dionex Offices listed in “Dionex Worldwide Offices” on the Dionex Reference Library CD-ROM.

SECTION 2 – ION CHROMATOGRAPHY SYSTEMS

The proper configuration of an Ion Chromatography System (ICS) in 2-mm or 4-mm format is based on the ratio of the 2-mm to 4-mm column cross-sectional area (a factor of 1/4). The selected format will affect the type of pump recommended. A gradient pump is designed to blend and pump isocratic, linear, or gradient mixtures of up to four mobile phase components at precisely controlled flow rates. An isocratic pump is for applications not requiring gradient and multi-eluent proportioning capabilities. Both are offered in either standard bore or microbore options.

- For an ICS in 2-mm format, Dionex recommends a microbore isocratic pump, standard bore isocratic pump, microbore gradient pump, or standard bore gradient pump.
- For an ICS in 4-mm format, Dionex recommends a standard bore isocratic pump or standard bore gradient pump.
- For an ICS in 0.4 mm format, Dionex recommends a Capillary IC system such as the ICS-5000 system.

See Appendix B, "Configuration" for specific recommended settings and parts including pumps, eluent flow rate, Self-Regenerating Suppressor (SRS), MicroMembrane Suppressor (MMS), Capillary Electrolytic Suppressor (CES), injection loop, system void volume, detectors, and tubing back pressure.



NOTE *Do not operate suppressors over 40 °C. If application requires a higher temperature, place the suppressor outside of the chromatographic oven. Use of an EG40 (P/N 053920) or EG50 (P/N 060585) with an EGC III KOH (P/N 074532) or EGC III NaOH (P/N 074533) cartridge for gradient applications is highly recommended for minimum baseline change when performing eluent step changes or gradients.*

SECTION 3 – INSTALLATION

3.1. System Requirements

3.1.1. System Requirements for 0.4 mm Operation

The IonPac AS20 0.4 mm Capillary Guard and Capillary Column are designed to be run on a capillary ion chromatograph system equipped with suppressed conductivity detection. It is recommended to run the capillary column only on the ICS-5000 capillary system for best performance.

3.1.2. System Requirements for 2-mm Operation

The IonPac AS20 2-mm Guard and Analytical Columns are designed to run on Dionex Ion Chromatographs equipped with suppressed conductivity detection. Isocratic analyses at flow rates of 0.5 mL/min or greater can be performed on a pump with standard (1/8" pistons) pump heads. For isocratic analyses at flow rates below 0.5 mL/min and gradient analyses, a microbore pump (1/16" pistons) is recommended.

3.1.3. System Requirements for 4-mm Operation

The IonPac AS20 4-mm Guard and Analytical Columns are designed to run on any Dionex Ion Chromatograph equipped with suppressed conductivity detection. Gradient methods and methods requiring solvent containing eluents should be performed on a system having a pump with a standard pump heads (1/8" pistons). Isocratic analysis can also be performed on a pump with standard bore pump heads (1/8" pistons).

3.1.4. System Void Volume

When using 2-mm columns, it is particularly important to minimize system void volume. The system void volume should be scaled down to at least 1/4 of the system volume in a standard 4 mm system. For best performance, all of the tubing installed between the injection valve and detector should be 0.005" ID PEEK tubing (P/N 044221).

0.010" ID PEEK tubing (P/N 042260) may be used but peak efficiency will be compromised which may also result in decreased peak resolution. Minimize the lengths of all connecting tubing and remove all unnecessary switching valves and couplers.

3.2. The Sample Concentrator

- For Trace Perchlorate work on an analytical scale system, use the Cryptand C1 Concentrator Column (P/N 062893) when the sample is delivered with a syringe or autosampler.

The Trace Anion Concentrator Low Pressure Column (TAC-LP1, P/N 046026), the Trace Anion Concentrator Ultra Low Pressure Column (TAC-ULP1, P/N 061400), the Ultra Trace Anion Concentrator Low Pressure Column (UTAC-LP1, P/N 063079) or (UTACL2, P/N 072779), the Ultra Trace Anion Concentrator Ultra Low Pressure Column (UTAC-ULP1, P/N 063475) or (UTAC-ULP2, P/N 072780), the Ultra Trace Anion Concentrator Extremely Low Pressure Column (UTAC-XLP1, P/N 063459) or (UTAC-XLP2, P/N 072781), or the IonPac AG20 Guard Column can be used for trace anion concentration work with the 2 mm and 4 mm AS20 columns. The function of a concentrator column in these applications is to strip ions from a measured volume of a relatively clean aqueous sample matrix. This process “concentrates” the desired analyte species onto the concentrator column, lowering detection limits by 2-5 orders of magnitude. The concentrator column is used in lieu of the sample loop.

Pump the sample onto the concentrator column in the OPPOSITE direction of the eluent flow. When using concentration techniques, do not overload the concentrator column by concentrating an excessive amount of sample. Concentrating an excessive amount of sample can result in inaccurate results being obtained. It is possible during the concentration step for the polyvalent anions such as phosphate and sulfate to elute the weakly retained anions such as fluoride and acetate off the concentrator column. For Trace Anion Concentration work with the 0.4 mm AS20 column use the IonSwift MAC-100 or MAC-200 Concentrator Column.

For more detailed information on sample concentration techniques for high sensitivity work and a detailed discussion of anion concentration techniques refer to:

- Section 3, “Operation,” of the Trace Anion Concentrator Low Pressure (TAC-LP1) and Ultra Low Pressure (TACULP1) Column Product Manual (Document No. 034972),
- Section 3, “Operation,” of the Ultra Trace Anion Concentrator Low Pressure (UTAC-LP1), Ultra Low Pressure (UTAC-ULP1), and Extremely Low Pressure (UTAC-XLP1) Column Product Manual (Document No. 065091.)
- Section 4, “Operation,” of the Ultra Trace Anion Concentrator 2 Low Pressure (UTAC-LP2), Ultra Low Pressure (UTAC-ULP2), and Extremely Low Pressure (UTAC-XLP2) Column Product Manual (Document No. 065376.)



CAUTION

IonPac Trace Anion Concentrator Column, TAC-2 (P/N 043101), is not optimized for use with hydroxide eluents and should not be used for concentrator work with the AS20. Instead, Concentrators (Cryptand C1, TAC-LP1, TAC-ULP1, UTAC 1 or UTAC 2) or Guards (AG20 4-mm or AG20 2-mm) should be used.

3.3. The Injection Loop

3.3.1. The 2-mm System Injection Loop, 2 - 15 μL

For most applications on a 2-mm analytical system, a 2 - 15 μL injection loop is sufficient. Generally, do not inject more than 12.5 nanomoles of any one analyte onto a 2-mm analytical column. Injecting larger number of moles of a sample can result in overloading the column which can affect the detection linearity. For low concentrations of analytes, larger injection loops can be used to increase sensitivity. The AS20 2-mm requires a microbore HPLC system configuration. Install an injection loop one-fourth or less (<15 μL) of the loop volume used with a 4 mm analytical system.

3.3.2. The 4-mm System Injection Loop, 10 - 50 μL

For most applications on a 4-mm analytical system, a 10 - 50 μL injection loop is sufficient. Generally, do not inject more than 50 nanomoles of any one analyte onto the 4-mm analytical column. Injecting larger number of moles of a sample can result in overloading the column which can affect the detection linearity. For low concentrations of analytes, larger injection loops can be used to increase sensitivity.

3.3.3. The 0.4-mm System Injection Loop, 0.4 μL Internal Loop

For most applications on a 0.4-mm capillary system, a 0.4 μL injection loop is sufficient. For samples containing low concentrations of analytes, larger injection loops can be used to increase sensitivity.

3.4. The IonPac AG20 Guard Column

An IonPac AG20 Guard Column is normally used with the IonPac AS20 Analytical Column. Retention times will increase by approximately 4% when a guard column is placed in-line prior to the analytical column. A guard is placed prior to the analytical column to prevent sample contaminants from eluting onto the analytical column. It is easier to clean or replace a guard column than it is an analytical column. Replacing the AG20 Guard Column at the first sign of peak efficiency loss or decreased retention time will prolong the life of the AS20 Analytical Column.

3.5. CR-ATC Trap Column Installation with EGC

For IonPac AS20 applications using the EGC KOH cartridge, a CR-ATC Continuously Regenerated Trap Column (P/N 060477 or 072078) should be installed at the EGC eluent outlet to remove trace level anionic contaminants from the carrier deionized water. See the CR-TC Product Manual (Document No. 031910) for instructions. As an alternative, the ATC-HC Trap Column (P/N 059604) should be installed between the pump outlet and the inlet of the EluGen Cartridge in the Module to remove anionic contaminants from the carrier deionized water. See the ATC-HC Product Manual (Document No. 032697) for instructions.

If the lower capacity ATC-3 Trap Column (P/N 059660 and 059661) is used, it should be installed between the gradient pump and the injection valve to remove anionic contaminants from the eluent. The ATC-3 column is used when performing sodium hydroxide gradient anion exchange applications using hand-prepared bottled eluents. See the ATC-3 Product Manual (Document No. 032697) for instructions.

The ATC-HC (P/N 059604) and ATC-3 Trap Columns will require off-line regeneration. To use the ATC-HC or ATC-3 Anion Trap Columns, refer to the Product Manuals.

3.6. Eluent Storage

IonPac AS20 columns are designed to be used with hydroxide eluent systems. Storage under a helium atmosphere ensures contamination free operation and proper pump performance. Nitrogen can be used if eluents do not contain solvents.

3.7. Anion Self-Regenerating Suppressor Requirements

An Anion Self-Regenerating Suppressor should be used for applications that require suppressed conductivity detection. It is compatible with solvent containing eluents and aqueous ionic eluents of all concentrations with which the systems and columns are compatible. Aqueous ionic eluents can be used in all ASRS 300 modes of operation.



Solvent containing eluents should be used in the AutoSuppression External Water Mode.

CAUTION

- For IonPac AS20 4-mm Analytical Column, use the ASRS 300 4-mm (P/N 061561).
- For IonPac AS20 2-mm Analytical Column, use the ASRS 300 2-mm (P/N 061562).
- For IonPac AS20 0.4-mm Capillary Column, use the ACES 300 0.4-mm (P/N 072052).

For detailed information on the operation of the Anion Self-Regenerating Suppressor 300, see the Product Manual for the ASRS 300 (Document No. 031956).

For detailed information on the operation of the Anion Capillary Electrolytic Suppressor 300, see the Product Manual for the ACES 300 (Document No. 065386).

3.8. Anion MicroMembrane Suppressor Requirements

An Anion MicroMembrane Suppressor (AMMS 300) may be used instead of an ASRS 300 4-mm for applications that require suppressed conductivity detection. Use an AMMS 300 4-mm (P/N 064558) with the IonPac AS20 4-mm Analytical Column. It is compatible with all solvents and concentrations with which the systems and columns are compatible. For 2-mm operation, use the AMMS 300 2-mm (P/N 064559).

For detailed information on the operation of the Anion MicroMembrane Suppressor, see Document No. 031727, the Product Manual for the AMMS 300.

3.9. Using Displacement Chemical Regeneration (DCR) in the Chemical Suppression Mode

Dionex recommends using the Displacement Chemical Regeneration (DCR) Mode for chemical suppression using sulfuric acid and the Anion MicroMembrane Suppressor (AMMS 300). See the DCR kit manual, Document P/N 031664, for details.



Use proper safety precautions in handling acids and bases.

SAFETY

3.10. Detector Requirements

See Section 2, "Ion Chromatography Systems," for 2-mm, 4-mm and 0.4-mm system detector, cell and thermal stabilizer requirements.

3.11. Using the EGC-KOH with AS20

Please refer to the EG40 manual, Document No. 031373, for information on the operation of the EG40. Please refer to the EG50 Product Manual, Document No. 031908, for information on the operation of the EG50. The AS20 column is recommended for use with ICS-2000, or ICS-3000 IC Systems equipped with an Eluent Generator. The AS20 can be used with older Dionex IC Systems equipped with an EG40 Eluent Generator or an RFC-30 Reagent Free Controller. The Eluent Generator is used to automatically produce potassium hydroxide gradients from deionized water.

3.12. Detector Requirements

See Section 2, "Ion Chromatography Systems," for 2-mm, 4-mm and 0.4-mm system detector, cell and thermal stabilizer requirements.

3.13. Installation of the Capillary Column

1. Before installing the new separator column, tear off the column label and slide it into the holder on the front of the cartridge (see Figure 1).
2. For reference, Figure 1 shows the column cartridge after installation of both a capillary guard column and a capillary separator column. Figure 2 shows the column cartridge after installation of only a capillary separator column.

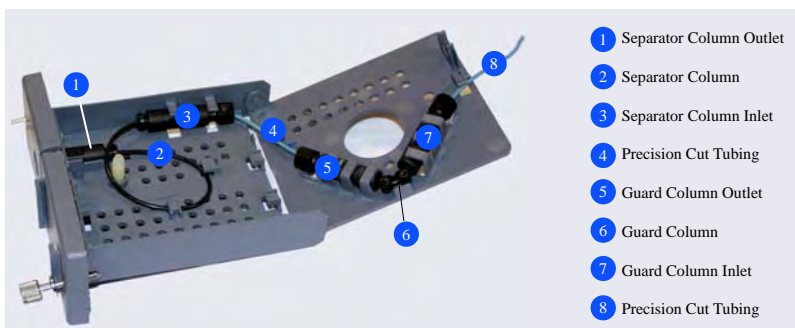

Figure 1
Separator and Guard Columns Installed in Column Cartridge

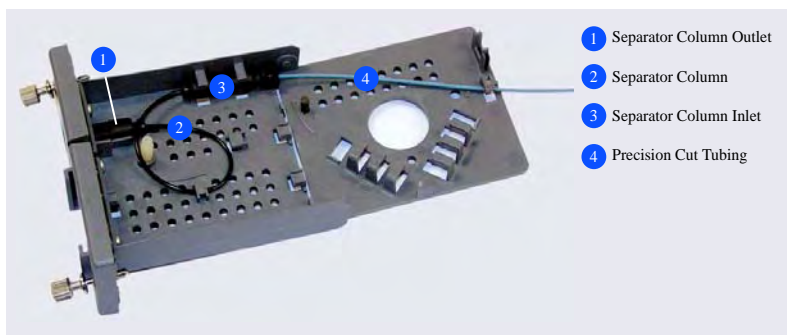

Figure 2
Separator Column Only Installed in Column Cartridge

3. Locate the IC Cube Tubing Kit (P/N 072186) that is shipped with the IC Cube. The tubing kit includes the following items:

Table 3
Contents of the IC Cube Tubing Kit (P/N 072186)

Part	Length / Quantity	Part Number	Used To Connect...
Precision cut 0.062-mm (0.0025-in) ID PEEK tubing, blue	65 mm (2.56 in)	072188	50 mm guard column outlet to 250 mm separator column inlet
Precision cut 0.062-mm (0.0025-in) ID PEEK tubing, blue, labeled VALVE PORT 3	115 mm (4.53 in)	072189	Guard column inlet to injection valve
Precision cut 0.062-mm (0.0025-in) ID PEEK tubing, blue	75 mm (2.93 in)	074603	35 mm guard column outlet to 150 mm separator column inlet
Precision cut 0.062-mm (0.0025-in) ID PEEK tubing, blue, labeled VALVE PORT 3	210 mm (8.27 in)	072187	Separator column inlet to injection valve (if a guard column is not present)
0.25-mm (0.010-in) ID PEEK tubing, black	610 mm (24 in)	042690	EG degas cartridge REGEN OUT to waste (if an EG is not present)
Fitting bolt, 10-32 hex double-cone (smaller), black	3	072949	Connect precision cut 0.062-mm (0.0025-in) ID PEEK tubing
Fitting bolt, 10-32 double-cone (larger), black	1	043275	Connect 0.25-mm (0.010-in) ID PEEK tubing (black)
Ferrule fitting, 10-32 double-cone, tan	4	043276	Use with both sizes of fitting bolts

4. Refer to the following figures for the precision cut tubing required for your configuration:

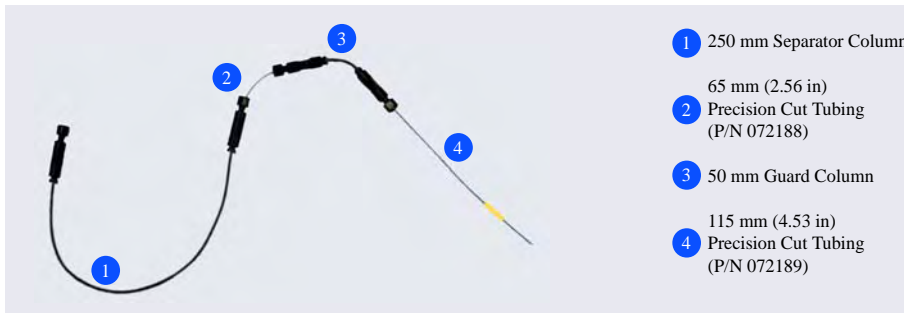

Figure 3
Tubing Connections for 250-mm Separator Column and 50-mm Guard Column

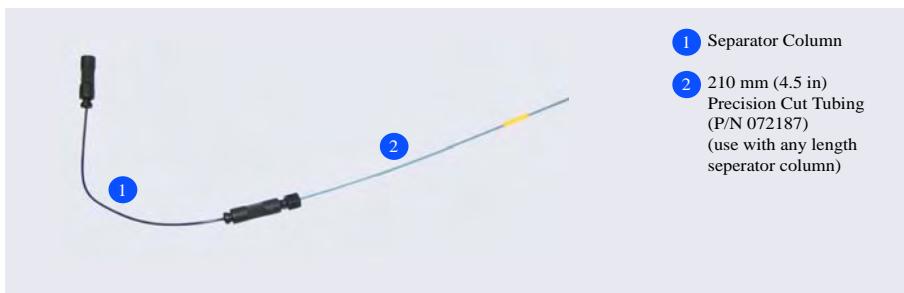

Figure 4
Tubing Connections for Separator Column Only

- Lift up the lid of the column cartridge to open it.
- Remove the fitting plug from the outlet fitting on the separator column. Orient the fitting with a flat side up (see Figure 5) and push the fitting into the opening at the front of the column cartridge until it stops.



Figure 5
Column Outlet Fitting Installed in Column Cartridge

- Coil the separator column tubing inside the cartridge as shown in Figure 1 or Figure 2. Secure the column tubing and the inlet fitting in the clips on the column cartridge.
- Secure the inlet and outlet fittings on the guard column (if used) in the column clips on the lid of the column cartridge.
- Route the guard column inlet tubing (if used) or the separator column inlet tubing through the clip on the top edge of the column cartridge lid.
- Close the lid (you should hear a click) and route the tubing into the slot on the front of the column cartridge (see Figure 6).



NOTE

If the columns are installed correctly, the cartridge lid snaps closed easily. If the lid does not close easily, do not force it. Open the lid and verify that the columns and tubing are installed correctly and secured in the clips.



Figure 6
Column Cartridge Closed

SECTION 4 – OPERATION

4.1. General Operating Conditions

Sample Volume:	2-mm: 2.5 μ L Loop + 0.8 μ L Injection valve dead volume 4-mm: 10 μ L Loop + 0.8 μ L Injection valve dead volume 0.4-mm: 0.4 μ L Loop
Column:	2-mm: AS20 2-mm Analytical Column + AG20 2-mm Guard Column 4-mm: AS20 4-mm Analytical Column + AG20 4-mm Guard Column 0.4-mm: AS20 0.4-mm Capillary Column + AG20 0.4-mm Capillary Guard Column
Eluent:	35 mM KOH
Eluent Source:	EGC III KOH
Eluent Flow Rate:	2-mm: 0.25 mL/min 4-mm: 1.0 mL/min 0.4-mm: 0.010 mL/min
Temperature:	30 °C
SRS Suppressor:	Anion Self-Regenerating Suppressor, ASRS 300 (2-mm or 4-mm) Anion Capillary Electrolytic Suppressor, ACES 300 (0.4-mm) AutoSuppression Recycle Mode
or MMS Suppressor:	Anion MicroMembrane Suppressor, AMMS 300 (2-mm or 4-mm)
MMS Regenerant:	50 mN H ₂ SO ₄
Expected Background Conductivity:	< 1 μ S
Long-term Storage Solution (> 1 week):	100 mM Sodium Borate
Short-term Storage Solution (< 1 week):	Eluent

4.2. IonPac AS20 Operation Precautions

- a) Filter and Degas Eluents

Table 4
Filter and Degas Eluents

FILTER SAMPLES	
Eluent pH	Between 0 and 14
Sample pH	Between 0 and 14
Maximum Flow Rate for 2-mm Columns	0.5 mL/min
Maximum Flow Rate for 4-mm Columns	2.0 mL/min
Maximum Flow Rate for 0.4-mm Columns	0.02 mL/min
Maximum Operating Pressure	3,000 psi (20.68 MPa)

4.3. Chemical Purity Requirements

Obtaining reliable, consistent and accurate results requires eluents that are free of ionic impurities. Chemicals, solvents and deionized water used to prepare eluents must be of the highest purity available. Low trace impurities and low particle levels in eluents also help to protect your ion exchange columns and system components. Dionex cannot guarantee proper column performance when the quality of the chemicals, solvents and water used to prepare eluents has been compromised.

4.3.1. Inorganic Chemicals

Reagent Grade inorganic chemicals should always be used to prepare ionic eluents. Whenever possible, inorganic chemicals that meet or surpass the latest American Chemical Society standard for purity should be used. These inorganic chemicals will detail the purity by having an actual lot analysis on each label.

4.3.2. Deionized Water

The deionized water used to prepare eluents should be Type I Reagent Grade Water with a specific resistance of 18.2 megohm-cm. The deionized water should be free of ionized impurities, organics, microorganisms and particulate matter larger than 0.2 μ m. Bottled HPLC-Grade Water (with the exception of Burdick & Jackson) should not be used since most bottled water contains an unacceptable level of ionic impurities.

4.3.3. Solvents

Solvents can be added to the ionic eluents used with IonPac AS20 columns to modify the ion exchange process or improve sample solubility. The solvents used must be free of ionic impurities. However, since most manufacturers of solvents do not test for ionic impurities, it is important that the highest grade of solvents available be used. Currently, several manufacturers are making ultra high purity solvents that are compatible for HPLC and spectrophotometric applications. These ultra high purity solvents will usually ensure that your chromatography is not affected by ionic impurities in the solvent. Currently at Dionex, we have obtained consistent results using High Purity Solvents manufactured by Burdick and Jackson and Optima[®] Solvents by Fisher Scientific.

When using a solvent in an ionic eluent, column generated back pressures will depend on the solvent used, concentration of the solvent, the ionic strength of the eluent and the flow rate used. The column back pressure will vary as the composition of water-methanol and water-acetonitrile mixture varies. The maximum back pressure limit for the IonPac AS20 columns is 3,000 psi (20.68 MPa).

The AS20 can withstand common HPLC solvents in a concentration range of 0-100%. Solvents and water should be premixed in concentrations which allow proper mixing by the gradient pump and to minimize outgassing. Ensure that all of the inorganic chemicals are soluble in the highest solvent concentration to be used during the analysis.

Table 5
HPLC Solvents for Use with IonPac AS20 Columns

Solvent	Maximum Operating Concentration
Acetonitrile	100%
Methanol	100%
2-Propanol	100%
Tetrahydrofuran	20%*

*Higher concentration may only be used for limited duration applications such as column clean up at pressures < 2000 psi.



CAUTION

The ASRS 300 and the ACES 300 must be operated in the AutoSuppression External Water Mode when using eluents containing solvents. Do not use > 40% solvent on the ASRS 300 and the ACES 300 in the electrolytic mode (power on).

4.4. Making Eluents that Contain Solvents

Remember to mix on a volume to volume basis when mixing solvents with water. If a procedure requires an eluent of 90% acetonitrile, prepare the eluent by adding 900 mL of acetonitrile to an eluent reservoir. Then add 100 mL of deionized water or eluent concentrate to the acetonitrile in the reservoir. Using this procedure to mix solvents with water will ensure that a consistent true v/v eluent is obtained. Premixing water with solvent will minimize the possibility of outgassing.



NOTE

When purging or degassing eluents containing solvents, do not purge or degas the eluent excessively since it is possible that a volatile solvent can be “boiled” off from the solution.



NOTE

Always degas and store all eluents in glass or plastic eluent bottles pressurized with helium. Only helium can be used to purge and degas ionic eluents containing solvents, since nitrogen is soluble in solvent containing eluents.



NOTE

Acetonitrile (ACN) hydrolyzes to ammonia and acetate when left exposed to basic solutions. To prevent eluent contamination from acetonitrile hydrolysis, always add acetonitrile to basic aqueous eluents by proportioning the acetonitrile into the basic eluent with the gradient pump. Keep the acetonitrile in a separate eluent bottle containing only acetonitrile and water.



SAFETY

Never add the acetonitrile directly to the basic carbonate or hydroxide eluent Solutions.

4.5. Eluent Preparation

4.5.1. Sodium Hydroxide Eluent Concentration

4.5.1.1. Weight Method

When formulating eluents from 50% sodium hydroxide, Dionex recommends weighing out the required amount of 50% sodium hydroxide. Use Fisher Grade 50% sodium hydroxide. Do not use pellets.

Example: To make 1 L of 35 mM NaOH use 2.80 g of 50% sodium hydroxide:

$$\text{For 35 mM: } \frac{0.035 \text{ mole/L} \times 40.00 \text{ g/mole}}{50\%} = 2.8 \text{ g diluted to 1 L}$$

4.5.1.2. Volume Method

Although it is more difficult to make precise carbonate-free eluents for gradient analysis volumetrically, you may choose to use the following formula to determine the correct volume of 50% sodium hydroxide to be diluted.

$$g = dvr$$

Where: g = weight of sodium hydroxide required (g)
 * d = density of the concentrated solution (g/mL)
 v = volume of the 50% sodium hydroxide required (mL)
 r = % purity of the concentrated solution

Example: To make 1 L of 35 mM NaOH use 1.83 mL of 50% sodium hydroxide:

$$\text{For 35 mM: } \frac{0.035 \text{ mole/L} \times 40.00 \text{ g/mole}}{50\% \times 1.53 \text{ g/mL}} = 1.83 \text{ mL diluted to 1 L}$$

* This density applies to 50% NaOH. If the concentration of the NaOH solution is significantly different from 50%, the upper (weight method) calculation should be used instead.

4.5.1.3. Sodium Hydroxide Eluents

Dilute the amount of 50% (w/w) NaOH (in water) specified in Table 6, "Dilution of 50% (w/w) NaOH to make standard AS20 eluents" with degassed, deionized water (with a specific resistance of 18.2 megohm-cm) to a final volume of 1,000 mL using a volumetric flask. Avoid the introduction of carbon dioxide from the air into the aliquot of 50% (w/w) NaOH or the deionized water being used to make the eluent. Do not shake the 50% (w/w) NaOH or pipette the required aliquot from the top of the solution where sodium carbonate may have formed.

Table 6
Dilution of 50% (w/w) NaOH to Make Standard AS20 Eluents

50% (w/w) NaOH g (mL)	Concentration of NaOH Eluent (mM)
0.40 (0.26)	5
2.8 (1.83)	35
8.00 (5.25)	100
160.00 (104.6)	2 M

4.6. Regenerant Preparation for the AMMS 300

The Anion MicroMembrane Suppressor 300 (AMMS 300) requires the use of a regenerant solution. If you are using the AMMS 300 instead of the Anion Self-Regenerating Suppressor 300 (ASRS 300), see the Product Manual for the AMMS 300 (Document No. 031727).

SECTION 5 – EXAMPLE APPLICATIONS

5.1. Recommendations for Optimum System Performance

The chromatograms in this section were obtained using columns that reproduced the Production Test Chromatogram (see Attachments, “QUALITY ASSURANCE REPORT”) on optimized Ion Chromatographs. Different systems will differ slightly in performance due to slight differences in column sets, system void volumes, liquid sweep-out times of different components and laboratory temperatures.

The IonPac AS20 is designed for the determination of trace concentrations of perchlorate using eluent delivered with an EGC KOH or EGC NaOH cartridge. Resolution of specific analytes can be further optimized if necessary by using gradient elution. In any type of gradient elution system it is important to use eluents that produce a minimum shift in baseline conductivity during the run, as well as a fast equilibration time from one run to the next. Because sodium or potassium hydroxide is converted to water in the suppressor, it is the best choice for an eluent. As long as the capacity of the suppressor is not exceeded, the eluent hydroxide concentration has little effect on background conductivity. For example, a gradient run could begin at 1.0 mM KOH and end at 80 mM KOH, with a resulting total baseline change of 1 to 2 μS .

DOWNWARD SHIFT IN BASELINE

Ensure that adequate equilibration time is allowed between runs. If downward shift in baseline is observed during the isocratic section of the chromatogram, increase the equilibration time.

INCREASE THE SENSITIVITY

You can increase the sensitivity of your system by using sample concentration techniques (see Section 3).



CAUTION

Carbon dioxide readily dissolves in dilute basic solutions forming carbonate. Carbonate contamination of eluents can affect the retention times of the anions being analyzed. Eluents should be maintained under an inert helium atmosphere to avoid carbonate contamination.

5.2. Production Test Chromatograms

Isocratic elution of inorganic anions including polarizable anions on the IonPac AS20 Analytical Column has been optimized utilizing a hydroxide eluent. By using this eluent, common inorganic anions including polarizable anions can be used to test the performance of the AS20 Column. The IonPac AS20 Analytical Column should always be used with the IonPac AG20 Guard Column. To guarantee that all IonPac AS20 Analytical Columns meet high quality and reproducible performance specification standards, all columns undergo the following production control test. An operating temperature of 30 °C is used to ensure reproducible resolution and retention. Note that the AG20 Guard is packed with a microporous resin of proportionally lower capacity and contributes approximately 4 % increase in retention times when a guard column is placed in-line prior to the analytical column.

Sample Volume: 2-mm: 2.5 μ L Loop + 0.8 μ L Injection valve dead volume
 4-mm: 10 μ L Loop + 0.8 μ L Injection valve dead volume

Column: See chromatogram

Eluent: 35 mM KOH

Eluent Flow Rate: 0.25 mL/min (2-mm), 1.0 mL/min (4-mm)

Operating Temperature: 30°C

SRS Suppressor: Anion Self-Regenerating Suppressor, ASRS 300
 (2-mm or 4-mm) ACES 300 AutoSuppression[®] Recycle Mode

or MMS Suppressor: Anion MicroMembrane Suppressor, AMMS 300
 (2-mm or 4-mm)

MMS Regenerant: 50 mN H₂SO₄

Expected Background Conductivity: < 3 μ S

Long-term Storage Solution (> 1 week): 100 mM Sodium Borate

Short-term Storage Solution (< 1 week): Eluent

Analyte	mg/L
1. Fluoride	2
2. Chloride	3
3. Sulfate	5
4. Thiosulfate	10
5. Iodide	20
6. Thiocyanate	20
7. Perchlorate	30

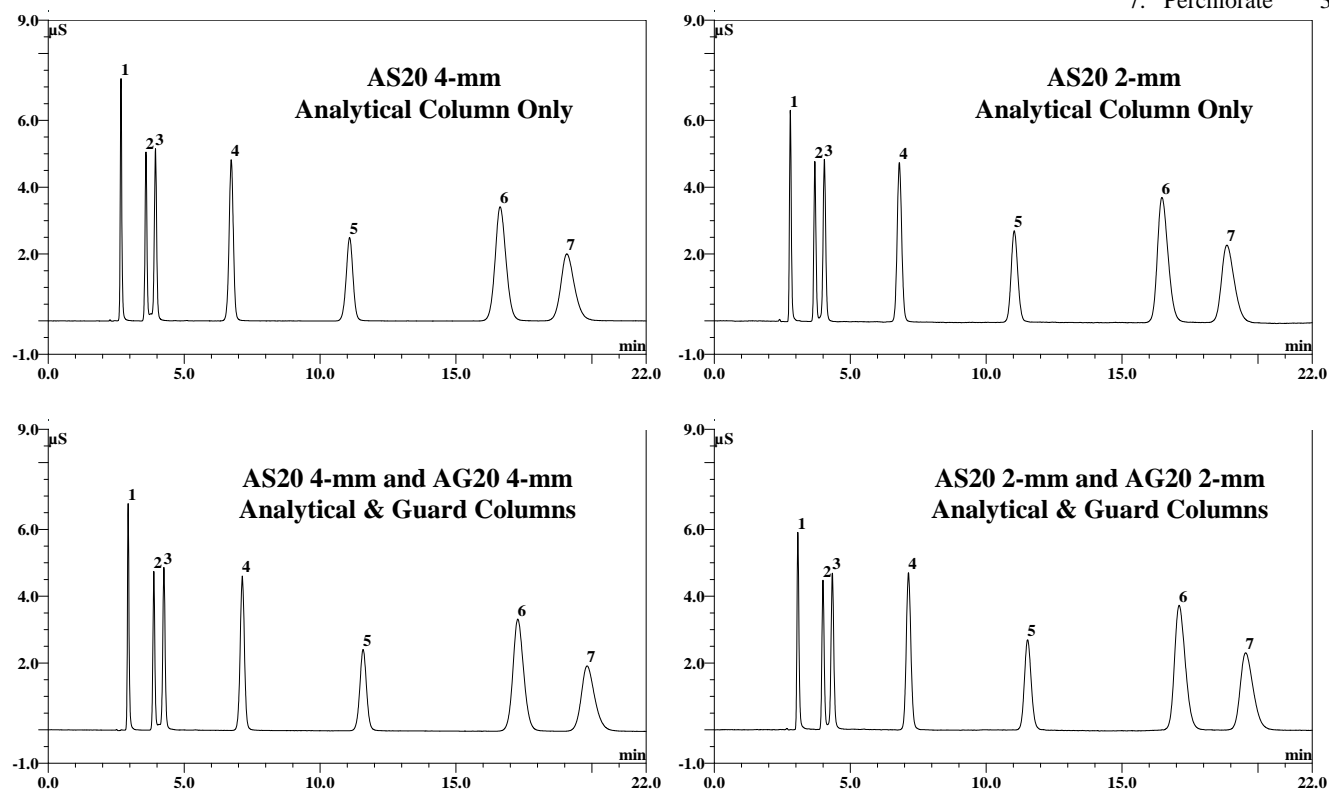

Figure 7
Production Test Chromatograms

5.3. Isocratic Separation of Polarizable Anions and 4 - Chlorobenzene Sulfonate

Aromatic sulfonates such as 4-chlorobenzene sulfonate, which can be found in leachates from some hazardous waste sites, can potentially interfere with the IonPac AS16 column. The presence of the 4-chlorobenzene sulfonate in an environmental sample may result in false positives for perchlorate. The IonPac AS20 has unique selectivity in that its resin substrate (aliphatic backbone) is different from the AS16 (aromatic backbone) and can resolve potential interferences from perchlorate.

Figure 8 shows the separation of common anions, hydrophobic anions, and 4-chlorobenzene sulfonate on the AS20 column. The unique selectivity of the AS20 resolves this potential interference from the perchlorate peak.

Injection volume: 2.5 μ L
Column: IonPac AS20 2 mm Analytical + AG20 2 mm Guard
Eluent: 35 mM NaOH
Eluent Source: EGC III NaOH Cartridge with CR-ATC
Flow Rate: 0.25 mL/min
Temperature: 30 $^{\circ}$ C
Suppressor: Anion Self-Regenerating Suppressor (ASRS, 2-mm)
Suppressor Mode: AutoSuppression Recycle

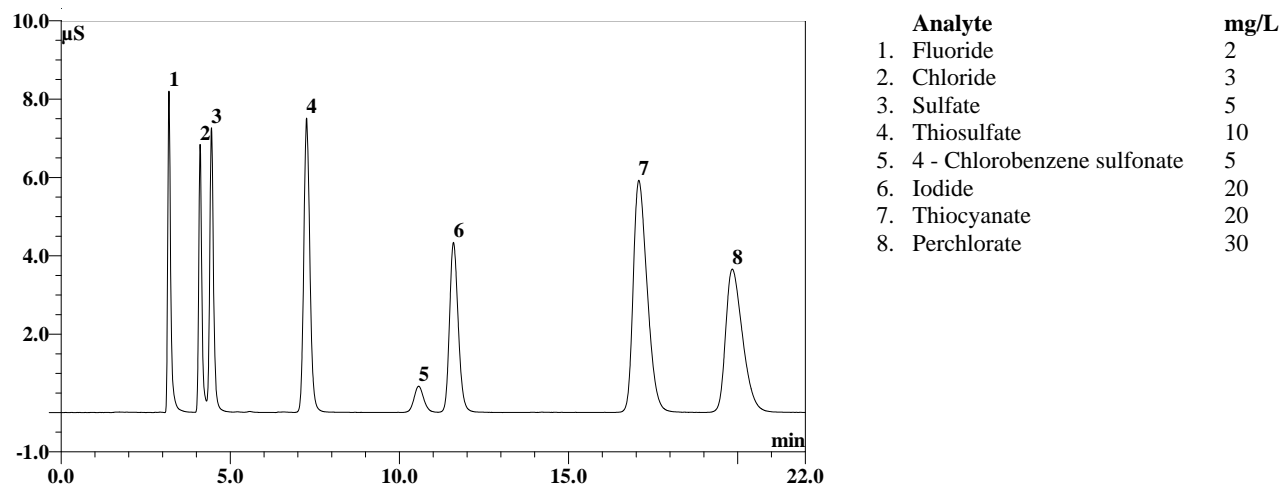

Figure 8
Isocratic Separation of Polarizable Anions and 4 - Chlorobenzene Sulfonate

5.4. Isocratic Separation of Common Anions and Polarizable Anions

The following chromatogram demonstrates the separation of common anions and polarizable anions using a hydroxide step change.



Bromide and Nitrate are baseline resolved with the AS20 column.

NOTE

Injection volume: 10 μ L
 Column: IonPac AS20 4-mm Analytical + AG20 4-mm Guard
 Eluent : Potassium hydroxide: 15 mM from 0 to 11 min and step change from 15 to 45 mM at 11.1 minutes
 Eluent Source: EGC III KOH Cartridge with CR-ATC
 Flow Rate: 1 mL/min
 Temperature: 30 °C
 Suppressor: Anion Self-Regenerating Suppressor (ASRS, 4-mm)
 Suppressor Mode: AutoSuppression Recycle

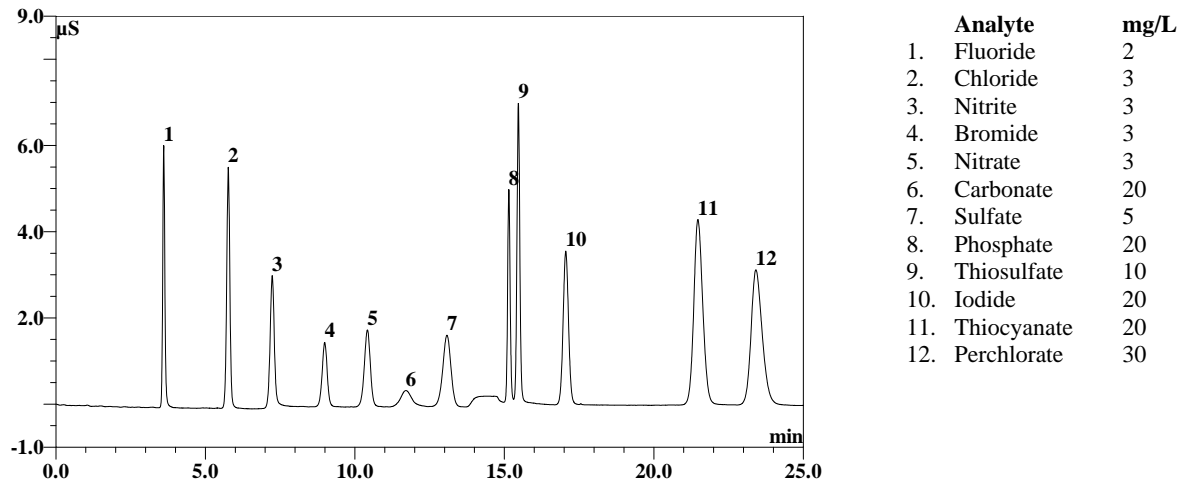

Figure 9
Isocratic Separation of 7 Anions and Polarizable Anions

5.5. Separation of Polarizable Anions and Inorganic Anions Using Gradient Elution

Figure 10 shows the separation of a wide variety of inorganic anions including polarizable anions. Weakly retained anions such as acetate, butyrate, and formate are resolved using an isocratic hydroxide eluent and the highly retained anions such as thiosulfate, thiocyanate, and perchlorate are eluted with a hydroxide gradient. Peak shape and efficiency are greatly improved for the polarizable anions on the IonPac AS20 column.

Sample Volume: 10 μ L
 Column: IonPac AS20 4-mm Analytical + AG20 4-mm Guard
 Eluent : Potassium hydroxide: 5 mM from 0 to 5 min, 5 to 30 mM from 5 to 15 minutes, and 30 to 55 mM from 15 to 30 minutes
 Eluent Source: EGC III KOH Cartridge with CR-ATC
 Eluent Flow Rate: 1 mL/min
 Operating Temperature: 30 $^{\circ}$ C
 SRS Suppressor: Anion Self-Regenerating Suppressor, ASRS (4-mm)
 AutoSuppression[®] Recycle Mode
 or MMS Suppressor: Anion MicroMembrane Suppressor, AMMS (4-mm)
 MMS Regenerant: 50 mN H₂SO₄

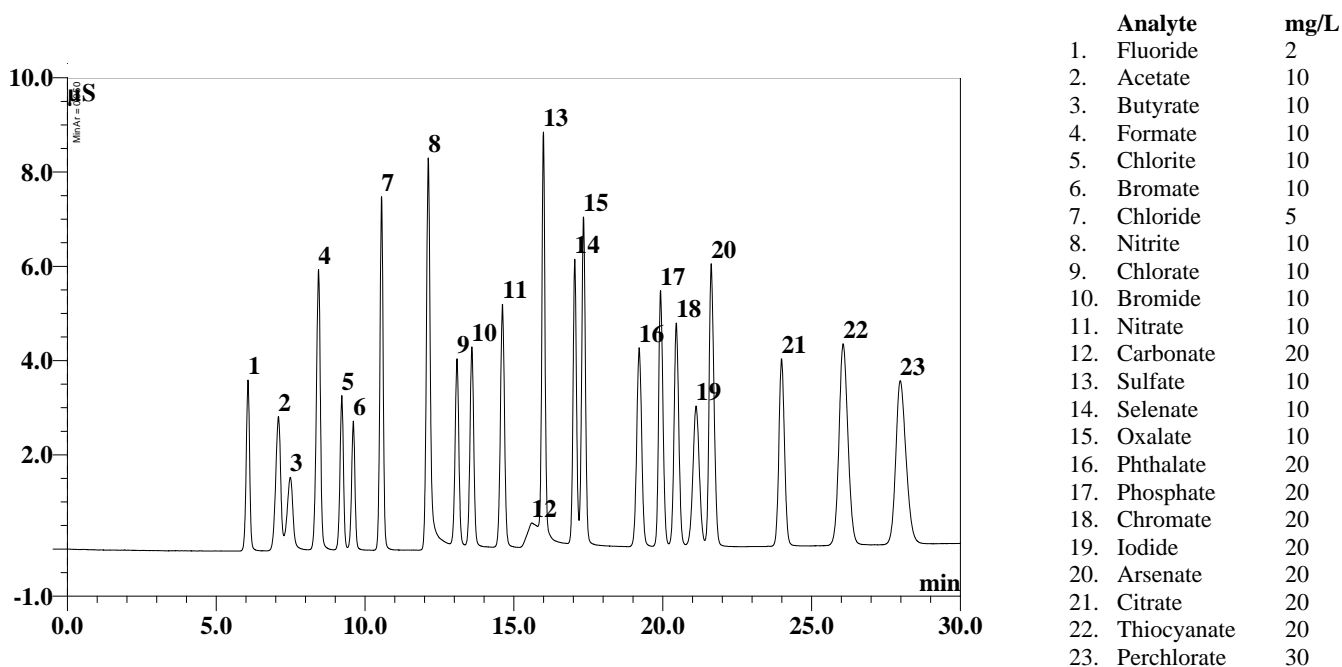
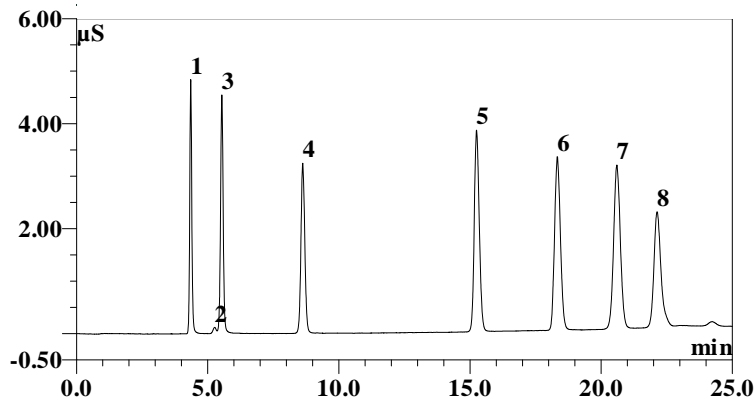

Figure 10
 Separation of Polarizable Anions and Inorganic Anions Using Gradient Elution

5.6. Separation of Polyphosphate Anions Using the Eluent Generator

Figures 11 and 12 show the separation of polyvalent phosphates using the Eluent Generator for eluent delivery. Notice the excellent separation of polyvalent phosphates using a gradient from 30 mM KOH to 55 mM KOH. In spite of the steep gradient, a minimum baseline shift is observed which facilitates quantitation of trace components as demonstrated in the dishwasher detergent chromatogram.

Sample Volume: 10 µL
 Column: IonPac AS20 4-mm Analytical + AG20 4-mm Guard
 Eluent : Potassium hydroxide: 25 to 55 mM from 0 to 20 minutes
 Eluent Source: EGC III KOH Cartridge with CR-ATC
 Eluent Flow Rate: 1 mL/min
 Operating Temperature: 30 °C
 SRS Suppressor: Anion Self-Regenerating Suppressor, ASRS (4-mm)
 AutoSuppression® Recycle Mode
 or MMS Suppressor: Anion MicroMembrane Suppressor, AMMS (4-mm)
 MMS Regenerant: 50 mN H₂SO₄



Analyte	mg/L
1. Chloride	3
2. Carbonate	*UNK
3. Sulfate	5
4. Phosphate	10
5. Pyrophosphate	15
6. Tripolyphosphate	15
7. Trimetaphosphate	15
8. Tetrametaphosphate	15

* UNK = Unknown

Figure 11

Separation of Polyphosphate Anions Using the Eluent Generator

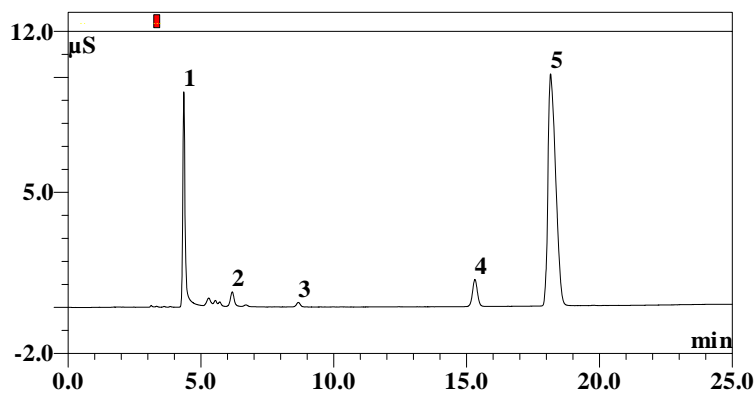

Analyte
1. Chloride
2. Unknown
3. Phosphate
4. Pyrophosphate
5. Tripolyphosphate

Figure 12

Dishwashing Detergent Sample, 500 mg/L

5.7. Determination of Trace Perchlorate in Drinking Water Using the AS20 Column and the Cryptand C1 Concentrator Column

Perchlorate, initially ammonium perchlorate, widely used in the manufacture of rocket propellants, munitions, fireworks, and road flares, has been found in drinking water in areas where aerospace materials and munitions have been manufactured and tested. Perchlorate is a potential health concern because it interferes with the production of thyroid hormones. The IonPac AS20 column was designed to determine trace perchlorate in groundwater and drinking water matrices. Figure 13 shows the determination of trace perchlorate in a drinking water sample using sample preconcentration with the Cryptand C1 Concentrator Column and a sodium hydroxide eluent coupled with suppressed conductivity detection. The Cryptand C1 Concentrator Column is used with sodium hydroxide eluent to allow optimum concentrator capacity control. At high concentrations of sodium, the Cryptand C1 has high capacity, but at lower concentrations the capacity decreases and the analytes can be eluted. Figure 14 shows the system flow path for the determination of trace perchlorate according to U.S. EPA Method 314.1.

Low- $\mu\text{g/L}$ (ppb) levels of perchlorate can easily be quantified using the AS20 column and a 2-mL sample preconcentration, as shown in Figure 13.

Column: IonPac[®] AG20, AS20, 2-mm
 Column: IonPac Cryptand C1, 4x35 mm
 Eluent: Sodium hydroxide: 0.5 mM from 0–12 min, 65 mM from 12.1–28 min, 100 mM from 28.1–30 min.
 Eluent Source: EGC III NaOH Cartridge with CR-ATC
 Temperature: 35 °C
 Flow Rate: 0.25 mL/min
 Inj. Volume: 2 mL
 Rinse Volume: 1 mL (10 mM NaOH)
 Detection: Suppressed conductivity, ASRS, 2 mm, AutoSuppression[®] external water mode, external water flow rate, 1-3 mL/min, 100 mA

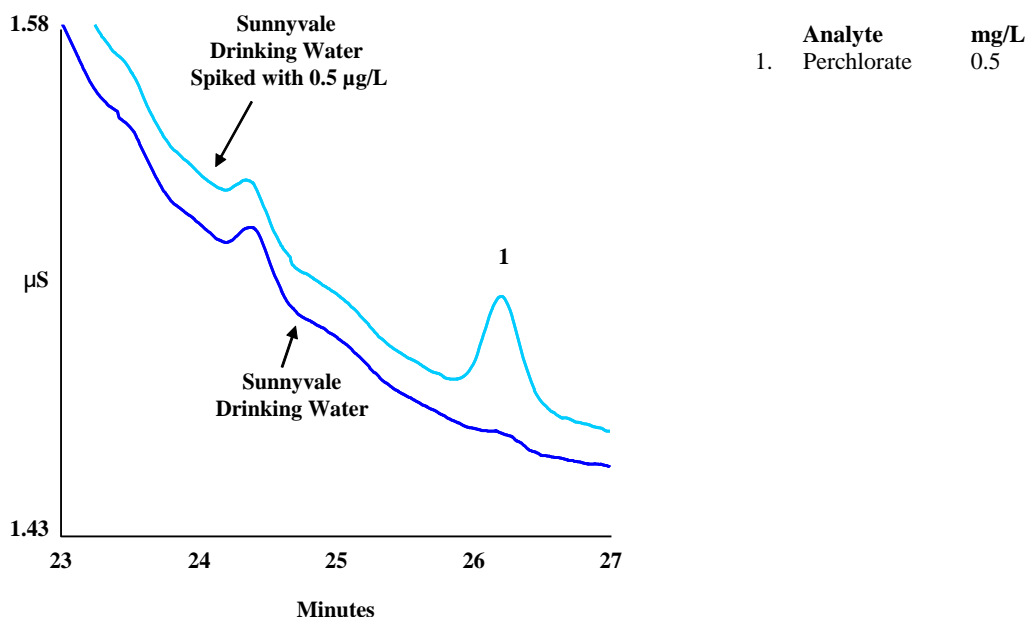
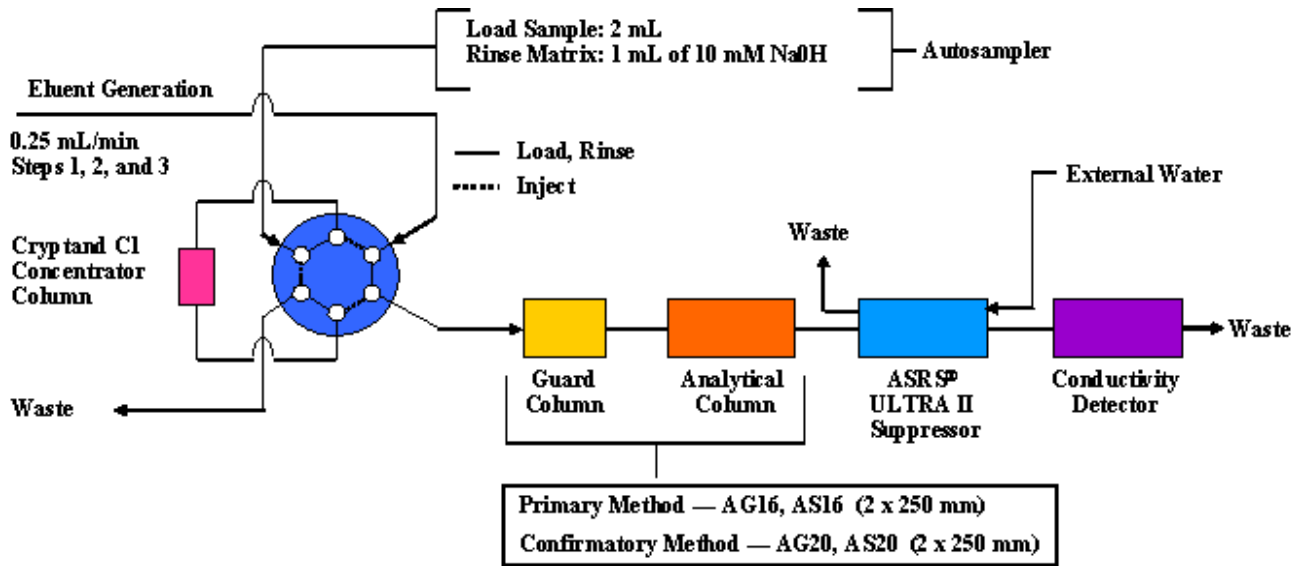

Figure 13
Determination of Trace Perchlorate in Drinking Water Using the AS20 Column and the Cryptand C1 Concentrator Column

NaOH Eluent Generation			
Steps	Function	Conc.	Time
1	Perchlorate Transfer	0.5 mM	12 min
2	Analysis	65 mM	16 min
3	Column Cleanup	100 mM	2 min



Autosampler must be capable of loading concentrator columns.

NOTE

Figure 14
 Perchlorate Analysis Using RFIC with Preconcentration
 and Matrix Rinse—EPA Method 314.1

5.8. Analysis of Anions Using the AS20 Capillary Column

Column: IonPac® AS20 (0.4 mm x 250 mm)
Eluent Source: Capillary EGC-KOH cartridge
Eluent: 35 mM KOH
Flow Rate: 10 μ L/min
Temperature: 30 $^{\circ}$ C
Suppressor: ACES 300 Anion Capillary Electrolytic Suppressor
Detection: Suppressed conductivity
Injection Volume: 0.4 μ L

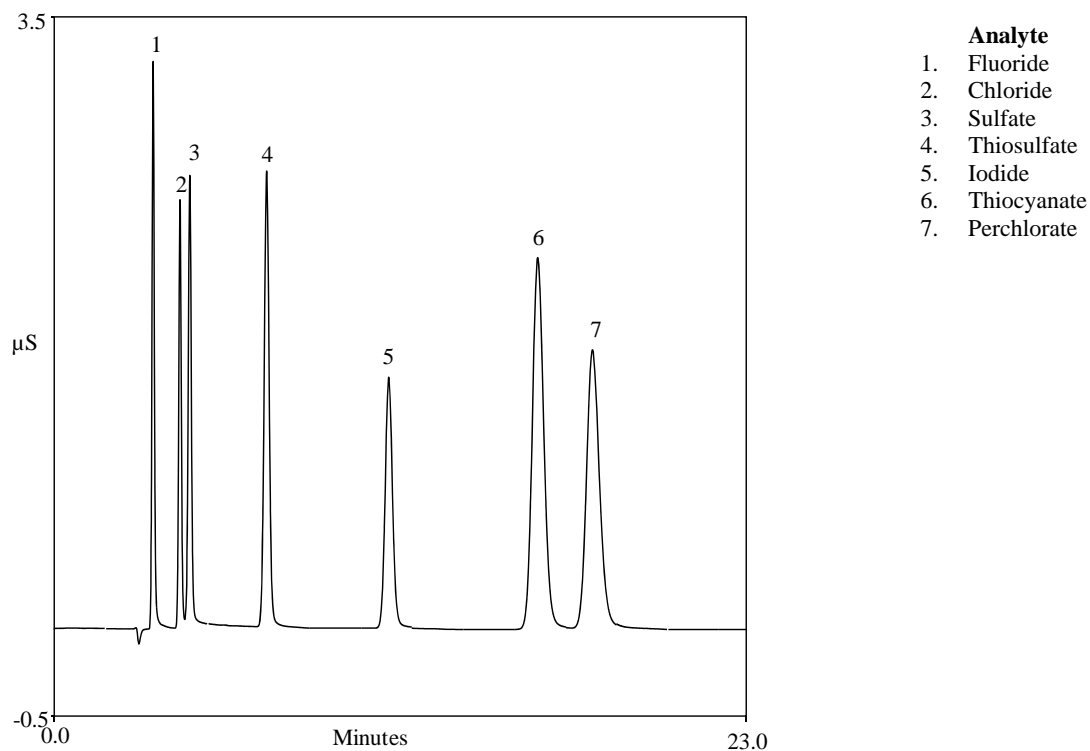

Figure 15
Analysis of Anions Using the AS20 Capillary Column

5.9. Determination of Trace Concentrations in Bromate Using the IonPac AS20 with Two-Dimensional Ion Chromatography

A. First-Dimension Conditions

Column: IonPac® AG19, AS19, 4 mm
Flow Rate: 1.0 mL/min
Eluent Source: EGC-KOH Cartridge
Eluent: 10 to 60 mM KOH
Suppressor: SRS 300, 4-mm
Inj. Volume: 1000 µL
Temperature: 30 °C

B. Second-Dimension Conditions

Column: IonPac AS20 Capillary Column (0.4 x 250 mm)
Flow Rate: 10 µL/min
Eluent Source: Capillary EGC-KOH Cartridge
Eluent: 35 mM KOH
Suppressor: ACES 300 Anion Capillary Electrolytic Suppressor
Temperature: 30 °C
Concentrator: IonSwift MAC-200 concentrator (0.75 x 80 mm),
2500 µL of 1st dimension suppressed effluent (7.5 to 10 minutes)

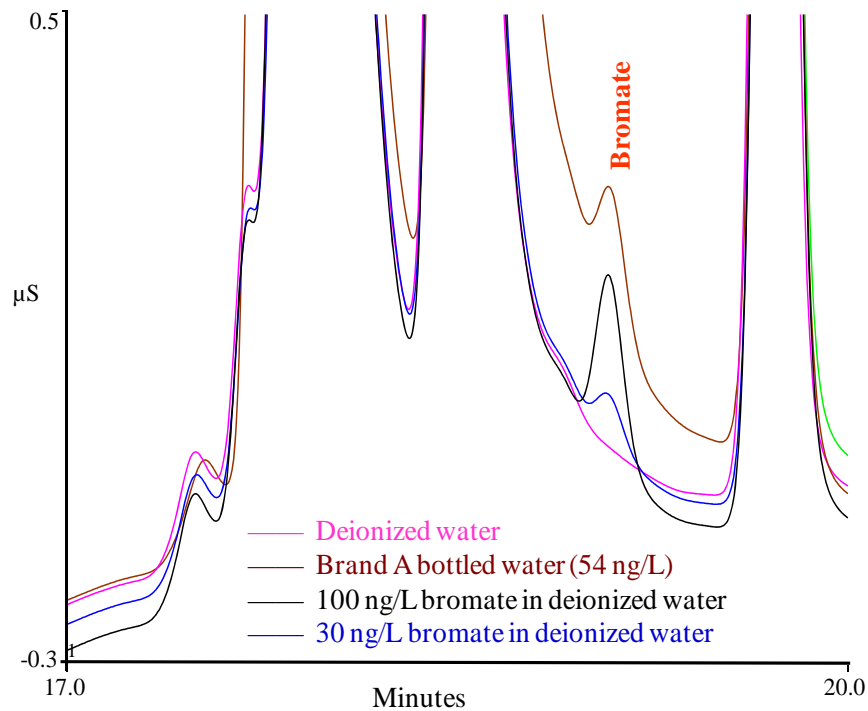

Figure 16
Determination of Trace Concentrations in Bromate Using the IonPac AS20 with Two-Dimensional Ion Chromatography

SECTION 6 – TROUBLESHOOTING GUIDE

The purpose of the Troubleshooting Guide is to help you solve operating problems that may arise while using IonPac AS20 columns. For more information on problems that originate with the Ion Chromatograph (IC) or the suppressor, refer to the Troubleshooting Guide in the appropriate operator's manual. If you cannot solve the problem on your own, contact the Dionex North America Technical Call Center at 1-800-DIONEX-0 (1-800-346-6390) or the nearest Dionex Office (see, "Dionex Worldwide Offices" on the Dionex Reference Library CD-ROM).

Table 7
AS20/AG20 Troubleshooting Summary

Observation	Cause	Action	Reference Section
High Back Pressure	Unknown	Isolate Blocked Component	6.1.1
	Plugged Column Bed Supports	Replace Bed Supports, Filter Eluents, and Filter Samples	6.1.2, 6.1.3, 6.1.4
	Other System Components	Unplug, Replace	Component Manual
High Background Conductivity	Contaminated Eluents	Remake Eluents	6.2, 6.2.1
	Contaminated Trap Column	Clean Trap Column	6.2.2, Component Manual
	Contaminated ASRS, ACES or AMMS	Clean Suppressor	6.2.6, Component Manual
	Contaminated Hardware	Clean Component	Component Manual
Poor Resolution	Poor Efficiency Due to Large System Void Volumes	Replumb System	6.3.1.A,
	Column Headspace	Replace Column	6.3.1.B
Short Retention Times	Flow Rate Too fast	Recalibrate Pump	6.3.2.A
	Conc. Incorrect Eluents	Remake Eluents	6.3.2.B
	Column Contamination	Clean Column	6.3.2.C, 6.3.2.D,
Poor Front End	Conc. Incorrect Eluents	Remake Eluents	6.3.3.A
Resolution	Column Overloading	Reduce Sample Size	6.3.3.B, 3.3.1, 3.3.2
	Sluggish Injection Valve	Service Valve	6.3.3.C, Component Manual
	Large System Void Volumes	Replumb System	6.3.3.D, Component Manual
Spurious Peaks	Sample Contaminated	Pretreat Samples	6.3.4.A, 6.3.4.B
	Sluggish Injection Valve	Service Valve	6.3.3.C, Component Manual

6.1. High Back Pressure

6.1.1. Finding the Source of High System Pressure

Total system pressure for the IonPac AG20 (4-mm) Guard Column plus the AS20 (4-mm) Analytical Column when using the test chromatogram conditions should be equal or less than 2,100 psi. If the system pressure is higher than 2,100 psi, determine the cause of the high system pressure. The system should be operated with a High-Pressure In-Line Filter (P/N 044105) which is positioned between the Gradient Pump pressure transducer and the injection valve. Make sure you have one in place and that it is not contaminated. The maximum flow rate is 2 mL/min and the maximum pressure is 3,000 psi (20.68 MPa).

- A. Ensure that the pump is set to the correct eluent flow rate. Higher than recommended eluent flow rates will cause higher pressure. Measure the pump flow rate if necessary with a stop watch and graduated cylinder.
- B. Determine which part of the system is causing the high pressure. High pressure could be due to a plugged tubing or tubing with collapsed walls, an injection valve with a clogged port, a column with particulates clogging the bed support, a clogged High-Pressure In-Line Filter, the Suppressor or the detector cell.

To determine which part of the chromatographic system is causing the problem, disconnect the pump eluent line from the injection valve and turn the pump on. Watch the pressure; it should not exceed 50 psi. Continue adding system components (injection valve, column(s), suppressor and detector) one by one, while monitoring the system pressure. The pressure should increase up to a maximum when the Guard and Analytical columns are connected (see Table 8, "Typical AS20/AG20 Operating Back Pressures").

The Anion Self-Regenerating Suppressor 300 may add up to 100 psi (0.69 MPa). No other components should add more than 100 psi (0.69 MPa) of pressure. Refer to the appropriate manual for cleanup or replacement of the problem component.

Table 8
Typical AS20/AG20 Operating Back Pressures

Column	Typical Back Pressure psi (MPa)	Flow Rate mL/min
AS20 4-mm Analytical	< 1800 (12.41)	1
AG20 4-mm Guard	< 300 (2.07)	1
AS20 + AG20 4-mm columns	< 2100 (14.48)	1
AS20 2-mm Analytical	< 1800 (12.41)	0.25
AG20 2-mm Guard	< 300 (2.07)	0.25
AS20 + AG20 2-mm columns	< 2100 (14.48)	0.25
AS20 0.4-mm Capillary	< 2200 (15.17)	0.01
AG20 0.4-mm Capillary Guard	< 300 (2.28)	0.01
AS20 + AG20 0.4-mm Columns	< 2500 (17.45)	0.01

6.1.2. Replacing Column Bed Support Assemblies

If the column inlet bed support is determined to be the cause of the high back pressure, it should be replaced. To change the inlet bed support assembly, refer to the following instructions, using one of the two spare inlet bed support assemblies included in the Ship Kit.

- a) Disconnect the column from the system.
- b) Carefully unscrew the inlet (top) column fitting. Use two open-end wrenches.
- c) Remove the bed support.
- d) Turn the end fitting over and tap it against a bench top or other hard, flat surface to remove the bed support and seal assembly. If the bed support must be pried out of the end fitting, use a sharp pointed object such as a pair of tweezers, but be careful that you do not scratch the walls of the end fitting.
- e) Discard the old bed support assembly.
- f) Place a new bed support assembly into the end fitting.
- g) Ensure that the end of the column tube is clean and free of any particulate matter so that it will properly seal against the bed support assembly.
- h) Use the end of the column to carefully start the bed support assembly into the end fitting.

Table 9
Product Information

Product	IonPac AS20 4-mm Columns (P/N)	IonPac AS20 2-mm Columns (P/N)	IonPac AS20 0.4-mm Columns (P/N)
Analytical Column	063148	063065	075399
Guard Column	063154	063066	075400
Bed Support Assembly	042955	044689	N/A
End Fitting	052809	043278	N/A



CAUTION

If the column tube end is not clean when inserted into the end fitting, particulate matter may obstruct a proper seal between the end of the column tube and the bed support assembly. If this is the case, additional tightening may not seal the column but instead damage the column tube or the end fitting.

- i) Screw the end fitting back onto the column. Tighten it finger tight, then an additional 1/4 turn (20 in. lb. for the 4-mm, 10 in.oz. for the 2-mm). Tighten further only if leaks are observed.
- j) Reconnect the column to the system
- k) Resume operation.



NOTE

Replace the outlet bed support ONLY if high pressure persists after replacement of the inlet fitting.

6.1.3. Filter Eluent

Eluents containing particulate material or bacteria may clog the column inlet bed support. Filter water used for eluents through a 0.45 μm filter.

6.1.4. Filter Samples

Samples containing particulate material may clog the column inlet bed support. Filter samples through a 0.45 μm filter prior to injection.

6.2. High Background or Noise

In a properly working system, the background conductivity level for the standard eluent system is shown below:

Table 10
Background Conductivity

Eluent	Expected Background Conductivity
35 mM NaOH (Bottle Eluent)	< 3 μS
35 mM EGC III KOH	< 1.0 μS

6.2.1. Preparation of Eluents

- Check the eluents and the regenerant (if used) are made correctly; specifically, check that eluents were made from chemicals with the recommended purity.
- Ensure the deionized water, used to prepare the reagents, has a specific resistance of 18.2 megohm-cm.

6.2.2. A Contaminated Trap Column

High background may be caused by contamination of the ATC-HC or ATC-3 with carbonate or other anions from the eluent.

- Clean the ATC-HC or 4-mm ATC-3 with 100 mL of 2.0 M NaOH or 50 mL for the 2-mm ATC-3.
- Rinse the ATC-HC or 4-mm ATC-3 immediately with 20 mL of eluent or 10 mL of eluent for the 2-mm ATC-3 into a beaker prior to use.

6.2.3. Contaminated CR-ATC Column

- Install a CR-TC Anion Trap Column (P/N 060477 or 072078) if using an Eluent Generator with EGC KOH or EGC NaOH cartridge.

If the CR-ATC becomes contaminated, please refer to Section 6, Clean-Up, in the CR-ATC Product Manual (Document No. 031910).

6.2.4. A Contaminated Guard or Analytical Column

- Remove the IonPac AG20 Guard and AS20 Analytical Columns from the system.
- Install a back pressure coil that generates approximately 1,500 psi and continue to pump eluent.
 - If the background conductivity decreases, the column(s) is (are) the cause of the high background conductivity.
- To eliminate downtime, clean or replace the AG20 at the first sign of column performance degradation.
 - Clean the column as instructed in, "Column Cleanup" (See "Column Care").

6.2.5. Contaminated Hardware

Eliminate the hardware as the source of the high background conductivity.

- a) Bypass the columns and the suppressor.
- b) Install a back pressure coil that generates approximately 1,500 psi and continue to pump eluent.
- c) Pump deionized water with a specific resistance of 18.2 megohm-cm through the system.
- d) The background conductivity should be less than 2 μ S. If it is not, check the detector/conductivity cell calibration by injecting deionized water directly into it. See the appropriate manual for details.

6.2.6. A Contaminated ASRS 300, ACES 300 or AMMS 300 Suppressor

If the above items have been checked and the problem persists, the Anion Self-Regenerating Suppressor, the Anion Capillary Electrolytic Suppressor or the Anion MicroMembrane Suppressor is probably causing the problem. For details on Anion Self-Regenerating Suppressor operation, refer to the Anion Self-Regenerating Suppressor 300 Product Manual (Document No. 031956). For details on Anion Membrane Suppressor 300 operation, refer to the Product Manual (Document No. 031727) for assistance. For details on the Anion Capillary Electrolytic Suppressor (ACES 300) operation, refer to the product manual (Document No. 065388) for assistance.

- a) Check the power level and alarms on the SRS Control.
- b) Check the regenerant flow rate at the REGEN OUT port of the ASRS if operating in the AutoSuppression External Waster mode or the Chemical Suppression mode or the AMMS.
- c) Check the eluent flow rate.
- d) If you are using an AutoRegen accessory with the ASRS in the Chemical Suppression Mode or the AMMS, prepare fresh regenerant solution.
- e) Test both the suppressor and the AutoRegen Regenerant Cartridge for contamination.
 - If the background conductivity is high after preparing fresh regenerant and bypassing the AutoRegen Regenerant Cartridge, you probably need to clean or replace your ASRS, ACES or AMMS.

If the background conductivity is low when freshly prepared regenerant is run through the ASRS or AMMS without an AutoRegen accessory in-line, test the AutoRegen Regenerant Cartridge to see if it is expended.

- a) Connect the freshly prepared regenerant to the AutoRegen Regenerant Cartridge.
- b) Pump approximately 200 mL of regenerant through the AutoRegen Regenerant Cartridge to waste before recycling the regenerant back to the regenerant reservoir.
 - If the background conductivity is high after placing the AutoRegen accessory in-line, you probably need to replace the AutoRegen Regenerant Cartridge. Refer to the “AutoRegen Regenerant Cartridge Refill Product Manual” (Document No. 032852) for assistance.

6.3. Poor Peak Resolution

Poor peak resolution can be due to any or all of the following factors.

6.3.1. Loss of Column Efficiency

6.3.1.1. Peak Fronting:

- a) Check to see if headspace has developed in the guard or analytical column.
 - This is usually due to improper use of the column such as submitting it to high pressures.
- b) Remove the column's top end fitting (see Section 6.1.2, “Replacing Column Bed Support Assemblies”).
 - If the resin does not fill the column body all the way to the top, it means that the resin bed has collapsed, creating a headspace. The column must be replaced.

6.3.1.2. Symmetric Inefficient Peaks:

- Extra-column effects can result in sample band dispersion, making the peaks' elution less efficient.
- a) Ensure you are using PEEK tubing with an ID of no greater than 0.010" for 4-mm systems or greater than 0.005" for 2-mm systems.
- b) Check all eluent liquid line connections between the injection valve and the detector cell inlet.
- c) Cut the tubing lengths as short as possible.
- d) Check for leaks.

6.3.2. Poor Resolution Due to Shortened Retention Times

**NOTE**

Even with adequate system and column efficiency, resolution of peaks will be compromised if analytes elute too fast.

6.3.2.1. Flow Rate:

- a) Check the flow rate to see if the eluent flow rate is equivalent to the flow rate specified by the analytical protocol.
- b) Measure the eluent flow rate after the column using a stopwatch and graduated cylinder.

6.3.2.2. Compositions and Concentrations:

- a) Check to see if the eluent compositions and concentrations are correct.
 - An eluent that is too concentrated will cause the peaks to elute faster.
- b) Prepare fresh eluent.

**NOTE**

If you are using a gradient pump to proportion the eluent, or components from two or three different eluent reservoirs, the resulting eluent composition may not be accurate enough for the application. This may be a problem when one of the proportioned eluents is less than 5%.

- c) Use one reservoir containing the correct eluent composition.

6.3.2.3. Column Contamination:

- Column contamination can lead to a loss of column capacity. This is because all of the anion exchange sites will no longer be available for the sample ions. For example, polyvalent anions from the sample or metals may concentrate on the column. Refer to, "Column Cleanup" (see "Column Care"), for recommended column cleanup procedures.

**NOTE**

Possible sources of column contamination are impurities in chemicals and in the deionized water used for eluents or components of the sample matrix. Be especially careful to make sure that the recommended chemicals are used. The deionized water should have a specific resistance of 18.2 megohm-cm.

6.3.2.4. Diluting the Eluent:

- Diluting the eluent will improve peak resolution, but will also increase the analytes' retention times. If a 10% dilution of the eluent is not sufficient to obtain the desired peak resolution, or if the resulting increase in retention times is unacceptable, clean the column (see, "Column Cleanup" in "Column Care").
 - a) After cleaning the column, reinstall it in the system.
 - b) Let the column equilibrate with eluent for about 30 minutes.
- No water wash is necessary. The column is equilibrated when consecutive injections of the standard give reproducible retention times. The original column capacity should be restored by this treatment, since the contaminants should be eluted from the column. If you need assistance in solving resolution problems, contact the Dionex North America Technical Call Center at 1-800-DIONEX-0 (1-800-346-6390) or the nearest Dionex Office (see, "Dionex Worldwide Offices" on the Dionex Reference Library CD-ROM).

6.3.3. Loss of Front End Resolution

If poor resolution or efficiency is observed for the peaks eluting near the system void volume compared to the later eluting peaks, check the following:

6.3.3.1. Improper Eluent Concentration

- a) Remake the eluent as required for your application.
- b) Ensure that the water and chemicals used are of the required purity.

6.3.3.2. Column Overloading

- a) Reduce the amount of sample ions being injected onto the analytical column by either diluting the sample or injecting a smaller volume onto the column.

6.3.3.3. Sluggish Operation of the Injection Valve

- a) Check the air pressure.
- b) Ensure there are no gas leaks.
- c) Check that the port faces are not partially plugged. Refer to the valve manual for instructions.

6.3.3.4. Improperly Swept Out Volumes

- a) Swap components, one at a time, in the system prior to the analytical column and test for front-end resolution after every system change. Remember to use the shortest tubing lengths possible.

6.3.4. Spurious Peaks

6.3.4.1. Contaminated Columns

- If the samples contain an appreciable level of polyvalent ions and the column is used with a weak eluent system, the retention times for the analytes will then decrease and be spurious, inefficient (broad) peaks that can show up at unexpected times.
 - a) Clean the column as indicated in "Column Cleanup" (see "Column Care").



NOTE

If you need assistance in determining the best way to clean strongly retained solutes in your specific sample matrix from the IonPac AS20 columns, contact the North America Technical Call Center at 1-800-DIONEX-0 (1-800-346-6390) or the nearest Dionex Office (see, "Dionex Worldwide Offices" on the Dionex Reference Library CD-ROM).

6.3.4.2. Injection Valve May Require Maintenance

- When an injection valve is actuated, the possibility of creating a baseline disturbance exists. This baseline upset can show up as a peak of varying size and shape. This will occur when the injection valve needs to be cleaned or retorqued (see valve manual).
- Check to see that there are no restrictions in the tubing connected to the valve.
 - Check the valve port faces for blockage and replace them if necessary. Refer to the Valve Manual for troubleshooting and service procedures.
- Small baseline disturbances at the beginning or at the end of the chromatogram can be overlooked as long as they do not interfere with the quantification of the peaks of interest.

6.3.5. Poor Efficiency Using Capillary Columns

Incorrectly installed fittings on capillary tubing can increase void volumes, causing chromatograms with tailing peaks.

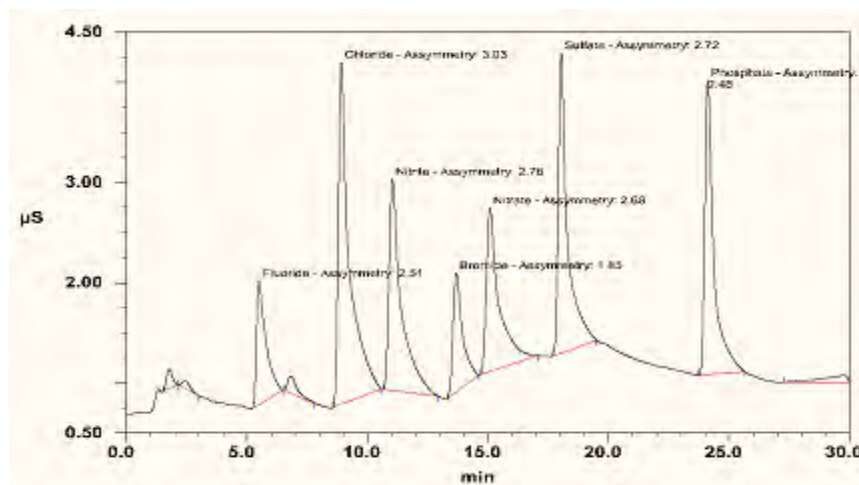

Figure 16
Tailing Peaks Caused by Incorrectly Installed
Capillary Tubing Fittings

When connecting a capillary tube fitting, make sure that the ferrule and fitting bolt are at least 2 mm (0.1 in) from the end of the tubing before you insert the tubing into the port. Do not place the ferrule and fitting bolt flush with the end of the tubing. Figure 17 illustrates the correct and incorrect placement of the ferrule and fitting bolt on the tubing.

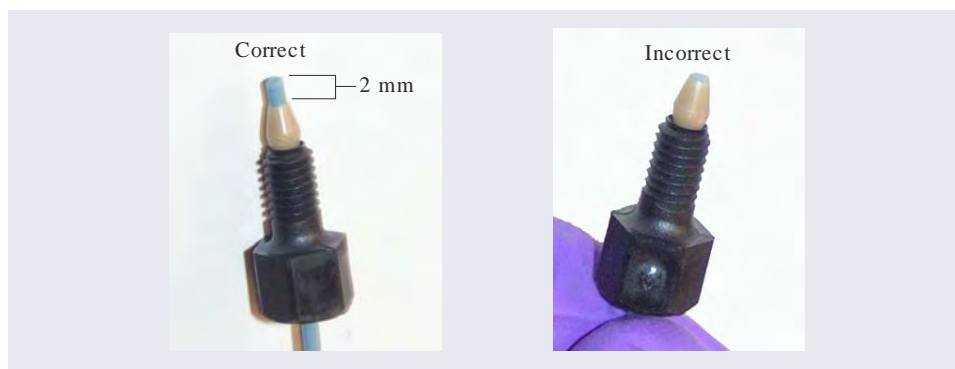

Figure 17
Correct and Incorrect Ferrule and
Fitting Bolt Placement for Capillary Tubing Connections

APPENDIX A - COLUMN CARE

A.1 Recommended Operating Pressure

Operating a column above its recommended pressure limit can cause irreversible loss of column performance. The maximum recommended operating pressure for IonPac AS20 columns is 3,000 psi (20.68 MPa).

A.2 Column Start-Up

The column is shipped using the column test eluent as the storage solution.

Prepare the eluent shown on the test chromatogram, install the column in the chromatography module and test the column performance under the conditions described in the test chromatogram. Continue making injections of the test standard until consecutive injections of the standard give reproducible retention times. Equilibration is complete when consecutive injections of the standard give reproducible retention times.

A.3 Column Storage

For short-term storage (< 1 week), use Eluent, for long-term storage (> 1 week), use 100 mM Sodium Borate for the column storage solution. Flush the column for a minimum of 10 minutes with the storage solution. Cap both ends securely, using the plugs supplied with the column.

A.4 Column Cleanup

The following column cleanup protocols have been divided into three general isocratic protocols to remove acid-soluble, base-soluble, or organic contaminants. They can be combined into one gradient protocol if desired; however, the following precautions should be observed.



WARNING

- *Always ensure that the cleanup protocol used does not switch between eluents which may create high pressure eluent interface zones in the column.*
- *High pressure zones can disrupt the uniformity of the packing of the column bed and irreversibly damage the performance of the column.*
- *High pressure zones in the column can be created by pumping successive eluents through the column that are not miscible, that have eluent components in one eluent that will precipitate out in the other eluent or by using an acid eluent followed by a base eluent which may create a neutralization pressure band.*
- *The precipitation of the salts in solvents during column rinses can result in very high pressure zones. High viscosity mixing zones can be created between two eluents having solvents with a very high energy of mixing.*

When in doubt, always include short column rinse steps to reduce the solvent content of the eluent to < 5% levels and the ionic strength of the eluent to < 50 mM levels to avoid creating high pressure zones in the column that may disrupt the uniformity of the column packing.

A.4.1 Choosing the Appropriate Cleanup Solution

Contamination	Solution
Hydrophilic Contamination of Low Valence	Concentrated hydroxide solutions such as a 10X concentrate of the most concentrated eluent used in the application is sufficient to remove hydrophilic contamination of low valence.
High Valence Hydrophilic Ions Contamination	Concentrated acid solutions such as 1 to 3 M HCl will remove high valence hydrophilic ions by ion suppression and elution by the chloride ion.
Metal Contamination	Metal contamination often results in asymmetric peak shapes and/or variable analyte recoveries. For example, iron or aluminum contamination often results in tailing of sulfate and phosphate. Aluminum contamination can also result in low phosphate recoveries.
	Concentrated acid solutions such as 1 to 3 M HCl remove a variety of metals. If after acid treatment, the chromatography still suggests metal contamination, treatment with chelating acids such as 0.2 M oxalic acid is recommended.
Nonionic and Hydrophobic Contamination	Organic solvents can be used alone if the contamination is nonionic and hydrophobic. The degree of nonpolar character of the solvent should be increased as the degree of hydrophobicity of the contamination within the range of acceptable solvents.
Ionic and Hydrophobic Contamination	Concentrated acid solutions such as 1 to 3 M HCl can be used with compatible organic solvents to remove contamination that is ionic and hydrophobic. The acid suppresses ionization and ion exchange interactions of the contamination with the resin.
	A frequently used cleanup solution is 200 mM HCl in 80% acetonitrile. This solution must be made immediately before use because the acetonitrile will decompose in the acid solution during long term storage.

A.4.2 Column Cleanup Procedure

Use the following cleanup procedures to clean the AG20 and AS20.

- Prepare a 500 mL solution of the appropriate cleanup solution using the guidelines in, "Choosing the Appropriate Cleanup Solution".
- Disconnect the ASRS 300, ACES 300 or AMMS 300 from the IonPac AS20 Analytical/Capillary Column.
- If your system is configured with both a guard column and an analytical or capillary column, reverse the order of the guard and analytical/capillary column in the eluent flow path.
- Double check that the eluent flows in the direction designated on each of the column labels.



CAUTION

When cleaning an analytical column and a guard column (or capillary and capillary guard) in series, ensure that the guard column is placed after the analytical/capillary column in the eluent flow path. If not, the contaminants that have accumulated on the guard column can be eluted onto the analytical/capillary column and irreversibly damage it. If in doubt, clean each column separately.

- Set the pump flow rate to 1.0 mL/min for an AS20 4-mm Analytical or Guard Column or set the pump flow rate to 0.25 mL/min for an AS20 2-mm Analytical or Guard Column. Set the pump flow rate to 0.010 mL/min for an AS20 Capillary or Capillary Guard Column.
- Rinse the column for 10 minutes with deionized water before pumping the chosen cleanup solution over the column.
- Pump the cleanup solution through the column for at least 60 minutes.
- Rinse the column for 10 minutes with deionized water before pumping eluent over the column.
- Equilibrate the column(s) with eluent for at least 60 minutes before resuming normal operation.
- Reconnect the ASRS 300, ACES 300 or AMMS 300 to the AS20 Analytical or Capillary Column
- Place the guard column in line between the injection valve and the analytical or capillary column if your system was originally configured with a guard column.

APPENDIX B - CONFIGURATION

Table B1
Configuration

CONFIGURATION	2-mm	4-mm	0.4-mm
Eluent Flow Rate	0.25 mL/min	1.0 µL/min	0.010 µL/min
SRS Suppressor	ASRS 300 (P/N 061562)	ASRS 300 (P/N 061561)	N/A
MMS Suppressor	AMMS 300 (P/N 056751)	AMMS 300 (P/N 056750)	N/A
ACES Suppressor	N/A	N/A	ACES 300 (P/N 072052)
NOTE:			
<i>Do not run suppressors over 40°C. If application requires a higher temperature, place suppressor outside of chromatographic oven.</i>			
Injection Loop	2 - 15 µL Use the Rheodyne Microinjection Valve, Model No. 9126 DIONEX P/N 044697) for full loop injections <15 µL.	10 - 50 µL	0.4 µL (typical)
System Void Volume	Eliminate switching valves, couplers and the GM-3 Gradient Mixer. Use only the 2 mm GM-4 Mixer (P/N 049135).	Minimize dead volumes. Switching valves, couplers can be used. Use the GM-2, GM-3 or recommended gradient mixers.	Use only in an IC system equipped for capillary analysis.
Pumps	Use the GS50/GP50/GP40/IP20/IP25 in Microbore Configuration with a Microbore GM-4 (2 mm) Gradient Mixer. The GPM-2 can be used for 2 mm isocratic chromatography at flow rates of 0.5 mL/min or greater but cannot be used for 2 mm gradient chromatography	Use the GP40/GP50/IP20/IP25 in Standard-Bore Configuration. The GM-3 Gradient Mixer should be used for gradient analysis on systems other than the GP50. The GP40 has an active mixer.	Use only a pump designed for capillary flow rates such as the ICS-5000 capillary pump.
NOTE:			
<i>Use of an EGC-KOH cartridge (P/N 074532 or 072076 in conjunction with a CR-ATC P/N 060477 or 072078) for gradient applications is highly recommended for minimum baseline change when performing eluent step changes or gradients.</i>			
Chromatographic Module	A thermally controlled column oven such as the LC25, LC30, ICS-10, 11, 15, 16, 20, 2100, 3000, 5000 DC	A thermally controlled column oven such as the LC25, LC30, ICS-10, 11, 15, 16, 20, 2100, 3000, 5000 DC	A thermally controlled column compartment such as the ICS-5000 DC or IC-Cube.

CONFIGURATION	2-mm	4-mm	0.4-mm
Detectors	AD20/AD25 Cell (6-mm, 7.5 μ L, P/N 046423) VDM-2 Cell (3-mm, 2.0 μ L) (P/N 043120) CD20, CD25, CD25A, ED40, ED50, or ED50A Conductivity Cell with DS3 P/N 044130 or Conductivity Cell with shield P/N 044132 CDM-2/CDM-3 Cell P/N 042770 Replace the TS-1 with the TS-2 (P/N 043117) on the CDM-2 or the CDM-3. The TS-2 has been optimized for 2-mm operation. Do not use the TS-2 or the TS-1 with the ED40/ED50/ED50A or the CD20/CD25/CD25A. Ensure 30–40 psi back pressure.	AD20/AD25 Cell (10-mm, 9 μ L, P/N 049393) VDM-2 Cell (6-mm, 10 μ L) P/N 043113 CD20, CD25, CD25A, ED40, ED50, or ED50A Conductivity Cell with DS3 P/N 044130 or with shield P/N 044132 CDM-2/CDM-3 Cell P/N 042770 Either the TS-1 with the TS-2 can be used with the CDM-2 or the CDM-3. Do not use the TS-2 or the TS-1 with the ED40/ED50/ED50A or the CD20/CD25/CD25A. Ensure 30–40 psi back pressure.	Use only a conductivity detector designed for capillary flow rates such as the ICS-5000 Capillary CD.

Table B2
Tubing Back Pressures

Color	Dionex P/N	I.D. inch	I.D. cm	Volume mL/ft	Back Pressure Psi/ft. at 1 mL/min	Back Pressure Psi/ft. at 0.25 mL/min	Back Pressure Psi/cm. at 1 mL/min
Green	044777	0.030	0.076	0.137	0.086	0.021	0.003
Orange	042855	0.020	0.051	0.061	0.435	0.109	0.015
Blue	049714	0.013	0.033	0.026	2.437	0.609	0.081
Black	042690	0.010	0.025	0.015	6.960	1.740	0.232
Red	044221	0.005	0.013	0.004	111.360	27.840	3.712
Yellow	049715	0.003	0.008	0.001	859.259	214.815	28.642
Light Blue	071870	0.0025	0.006	0.0009	1766.0	441.0	58.0

ATTACHMENT A - IONPAC AS20 2-MM ANALYTICAL 2X250 MM

IonPac® AS20
Analytical (2 x 250 mm)
Product No. 063065

Date: 09-Dec-04 08:23
Serial No. :
Lot No. :

Eluent: 35 mM KOH
Eluent Source: EGC-KOH II Cartridge
Flow Rate: 0.25 mL/min
Temperature: 30 °C
Detection: Suppressed Conductivity using a CD25
Suppressor: Anion Self-Regenerating Suppressor (ASRS®-ULTRA II, 2mm)
 AutoSuppression® Recycle Mode
Applied Current: 100 mA
Injection Volume: 2.5 µL
Long-term Storage Solution (> 1 week): 100 mM Sodium Borate
Short-term Storage Solution (< 1 week): Eluent

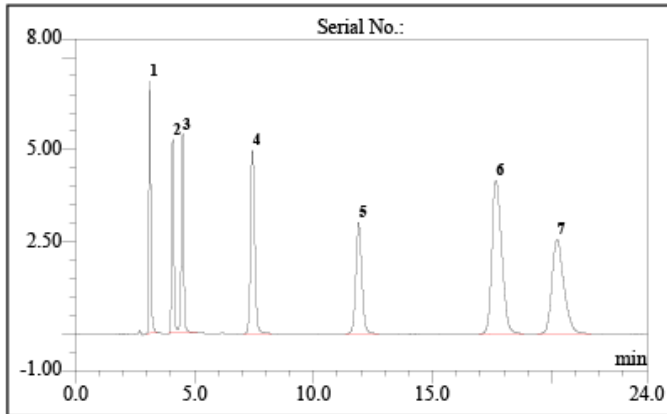

No.	Peak Name	Ret.Time (min)	Asymmetry (AIA)	Resolution (EP)	Efficiency (EP)	Concentration (mg/L)
1	Fluoride	3.12	1.25	6.69	8623	2.0
2	Chloride	4.09	1.10	2.31	11007	3.0
3	Sulfate	4.49	1.06	11.50	8864	5.0
4	Thiosulfate	7.44	1.10	11.30	8495	10.0
5	Iodide	11.89	1.14	9.54	10375	20.0
6	Thiocyanate	17.66	1.45	3.11	8975	20.0
7	Perchlorate	20.22	1.56	n.a.	8071	30.0

QA Results:

Analyte	Parameter	Specification	Results
Iodide	Efficiency	>=7650	Passed
Iodide	Asymmetry	1.00-1.76	Passed
Perchlorate	Retention Time	16.80-21.20	Passed
	Pressure	<=1980	1020

Production Reference:

Datasource: CON_SQL_local
 Sequence: AS20_2x250
 Sample No.: 1

6.50 SP4 Build 1000
 Chromeleon® Dionex Corp. 1996-2003

ATTACHMENT B - IONPAC AS20 4-MM ANALYTICAL 4X250 MM

IonPac® AS20
Analytical (4 x 250 mm)
Product No. 063148

Date: 16-Dec-04 11:16
Serial No. :
Lot No. :

Eluent: 35 mM KOH
Eluent Source: EGC-KOH II Cartridge
Flow Rate: 1.0 mL/min
Temperature: 30 °C
Detection: Suppressed Conductivity using a CD25
Suppressor: Anion Self-Regenerating Suppressor (ASRS®-ULTRA II, 4mm)
 AutoSuppression® Recycle Mode
Applied Current: 100 mA
Injection Volume: 10 µL
Long-term Storage Solution (> 1 week): 100 mM Sodium Borate
Short-term Storage Solution (< 1 week): Eluent

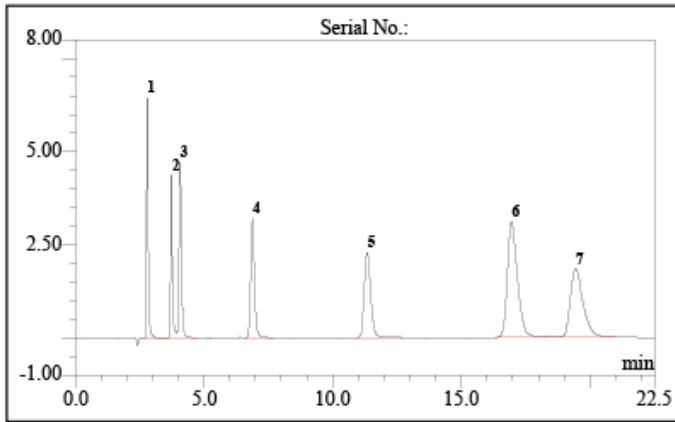

No.	Peak Name	Ret.Time (min)	Asymmetry (AIA)	Resolution (EP)	Efficiency (EP)	Concentration (mg/L)
1	Fluoride	2.79	1.65	8.26	12601	2.0
2	Chloride	3.72	1.49	2.39	13715	3.0
3	Sulfate	4.06	1.28	13.07	10987	5.0
4	Thiosulfate	6.88	1.18	12.53	9840	10.0
5	Iodide	11.34	1.22	9.86	10772	20.0
6	Thiocyanate	16.95	1.53	3.16	9271	20.0
7	Perchlorate	19.43	1.72	n.a.	7929	30.0

QA Results:

Analyte	Parameter	Specification	Results
Iodide	Efficiency	>=7650	Passed
Iodide	Asymmetry	1.00-1.76	Passed
Perchlorate	Retention Time	16.80-21.20	Passed
	Pressure	<=1980	1170

Production Reference:

Datasource: CON_SQL_local
 Sequence: AS20_4x250
 Sample No.: 1

6.50 SP4 Build 1000
 Chromeleon® Dionex Corp. 1996-2003

ATTACHMENT C - IONPAC AS20 CAPILLARY 0.4X250 MM

IonPac® AS20
Capillary (0.4 x 250 mm)
Product No. 075399

Date: 24-Sep-10 15:31
Serial No. : 000129
Lot No. :

Eluent: 35 mM KOH
Eluent Source: EGC-KOH (Capillary)
Flow Rate: 0.010 mL/min
Temperature: 30 °C
Detection: Suppressed Conductivity
Suppressor: Anion Capillary Electrolytic Suppressor (ACES 300)
 AutoSuppression® Recycle Mode
Applied Current: 9 mA
Injection Volume: 400 nL
Storage Solution: 100 mM Sodium Tetraborate

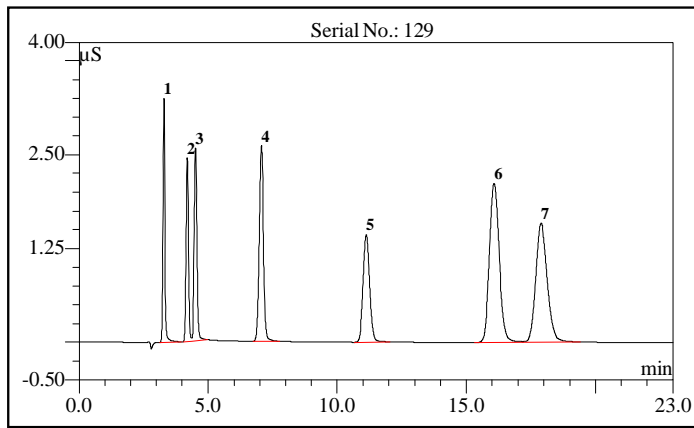

No.	Peak Name	Ret.Time (min)	Asymmetry (AIA)	Resolution (EP)	Efficiency (EP)	Concentration (mg/L)
1	Fluoride	3.28	1.1	6.07	8669	0.4
2	Chloride	4.19	1.0	1.88	11205	0.6
3	Sulfate	4.52	1.0	10.27	9010	1.0
4	Thiosulfate	7.06	1.0	10.79	8491	2.0
5	Iodide	11.12	1.1	8.76	9835	4.0
6	Thiocyanate	16.07	1.2	2.47	8813	4.0
7	Perchlorate	17.89	1.3	n.a.	8127	6.0

QA Results:

Analyte	Parameter	Specification	Results
Iodide	Efficiency	>=7650	Passed
Iodide	Asymmetry	1.0-1.8	Passed
Perchlorate	Retention Time	16.80-21.20	Passed
	Pressure	<=1980	1107

Production Reference:

Datasource: QAR
 Directory: Cap\AS20
 Sequence: AS20_p4X250MM
 Sample No.: 1

6.80 SR9a Build 2680 (163077) (Demo-Installation)

Chromleon® Dionex Corp. 1994-2010