

Now sold under the
Thermo Scientific brand

Thermo
SCIENTIFIC

Time Savings and Improved Reproducibility of Nitrate and Nitrite Ion Chromatography Determination in Milk Samples

INTRODUCTION

Cow's milk is of particular dietary value to infants, small children, and expectant mothers as it is an important source of calories, minerals (including calcium), fat-soluble vitamins A, D, E, and K, and protein. Because of its nutritional value, it is imperative that the commercial milk supply be free of contaminants such as nitrate and nitrite. The excessive consumption of nitrate can lead to underoxygenation of the blood and, consequently, underoxygenation of the tissues, which can cause numerous health problems, the most severe of which is death. With a much smaller total blood volume, infants and small children are more severely impacted than adults when consuming the same nitrate-contaminated product.

The most likely source of nitrate in the blood stream is drinking water. Drinking water can become contaminated in areas where there has been excessive application of nitrate-based fertilizers and where sodium or potassium nitrate is used in canisters designed to kill rodents. For an infant, the water used to prepare infant formula (baby food), the water consumed by the nursing mother, or the water consumed by dairy cattle whose milk is used to prepare milk-based infant formulas, are possible sources of nitrate. For most children, infant formula and mother's milk will eventually be replaced by cow's milk.

Nitrite is also a concern because it is easily oxidized to nitrate. Excessive consumption of nitrite and nitrate also has been implicated as a cause of other health problems.¹ For these reasons, the United States Environmental Protection Agency (U.S. EPA) regulates the amount of nitrite and nitrate in drinking water and has published an ion chromatography (IC) method for the determination of these two anions, along with fluoride, chloride, bromide, sulfate, and phosphate.² For the same reasons, the concentration of nitrite and nitrate should also be determined in milk.

The IC analytical technique is the most commonly used for simultaneously measuring nitrite and nitrate in samples. These two anions can be detected either by suppressed conductivity detection or by their absorbance at 210 nm.³ Unfortunately, milk samples cannot be injected directly onto the IC system to measure nitrite and nitrate because the milk fat will foul and eventually poison the column, and milk proteins will interfere with the chromatography and compromise the detection of nitrite and/or nitrate by either suppressed conductivity or absorbance detection. Even after one or more sample preparation steps, the remaining protein or other anionic molecules can interfere with nitrite and nitrate determination, or foul the column. The analyst must remove as many interfering compounds from the milk as possible while still achieving full recovery of nitrite and nitrate.

In this study, a milk sample is subjected to an acid precipitation step prior to loading the sample into an autosampler vial. The remainder of the sample preparation is completed in-line with an InGuard® HRP sample preparation cartridge. This saves the analyst time and reduces the possibility of sample contamination. Nitrite and nitrate are then separated on an IonPac® AS20 column set and detected by suppressed conductivity detection using a Reagent-Free™ IC (RFIC™) system. The RFIC system prepares the hydroxide eluent with high fidelity, which augments method reproducibility. The InGuard cartridge must be changed every 100 injections, which allows the column set to be used for approximately 1000 sample injections while still accurately determining the nitrite and nitrate contents of the milk sample with only minimal off-line sample preparation.

EQUIPMENT

Dionex ICS-3000 system* including:

DP Dual Pump

DC Detector/Chromatography module with dual-temperature zone equipped with two 6-port valves and a conductivity detector

EG Eluent Generator

AS Autosampler

EWP Electrolytic Water Purifier (P/N 071553)

AXP Auxiliary Pump (P/N 063973)

Chromeleon® Chromatography Data System (CDS) software Version 6.80 SR9

*This application can also be executed on an ICS-5000 system.

REAGENTS AND STANDARDS

Deionized water (DI), Type I reagent grade, 18 MΩ-cm resistivity or better

Concentrated acetic acid (CH₃COOH, Labscan)

Sodium Nitrite (NaNO₂, Fluka)

Sodium Nitrate (NaNO₃, Fluka)

Samples

Instant Powder Milk Sample #1 (containing 6.203% fat)

Instant Powder Milk Sample #2 (containing 1.799% fat)

PREPARATION OF SOLUTIONS AND REAGENTS

Eluent Solution

The eluent generator produces the eluent using the EluGen EGC II KOH cartridge and DI water supplied by the pump, with the eluent concentration controlled by the Chromeleon software. Backpressure tubing must be added to achieve 2000–2500 psi backpressure that will allow the EG degasser to function properly. See the ICS-3000 Ion Chromatography System Operator's Manual (P/N 065031-03) for instructions on adding backpressure.

Acetic Acid (3%)

Add 3 mL of concentrated acetic acid to approximately 50 mL of DI water in a 100 mL volumetric flask. Dilute to volume with DI water and mix.

Standard Solutions

Nitrite Stock Standard Solution (1000 mg/L)

Dissolve 0.150 g of sodium nitrite in a 100 mL volumetric flask with DI water.

Nitrate Stock Standard Solution (1000 mg/L)

Dissolve 0.137 g of sodium nitrate in a 100 mL volumetric flask with DI water.

Nitrite Standard Solution (10 mg/L)

Dilute 1 mL of 1000 mg/L nitrite standard in a 100 mL volumetric flask with DI water.

Nitrate Standard Solution (20 mg/L)

Dilute 2 mL of 1000 mg/L nitrate standard in a 100 mL volumetric flask with DI water.

Calibration Standard and Sample Preparation

Prepare calibration standard solutions by adding a known amount of standard solution into the sample during sample preparation. Weigh 1 g of milk powder into a 100 mL bottle, then add the appropriate volumes of 10 mg/L nitrite and 20 mg/L nitrate solutions to produce each calibration standard. Table 1 lists the volumes to be added of each standard and the subsequent concentrations in the sample.

Table 1. Volumes of 10 mg/L Nitrite, 20 mg/L Nitrate, 3% Acetic Acid, and DI Water Used for Each Preparation

Sample	Volume of Added Standard and Resulting Concentration (mL, mg/L)		Volume of 3% Acetic Acid Added (mL)	Volume of DI Water Added (mL)
	10 mg/L Nitrite	20 mg/L Nitrate		
Blank (no milk)	—	—	1	49.0
Unspiked*	—	—	1	49.0
Spiked 1*	0.1, 0.02	0.1, 0.04	1	48.8
Spiked 2*	0.2, 0.04	0.2, 0.08	1	48.6
Spiked 3*	0.4, 0.08	0.4, 0.16	1	48.2
Spiked 4*	0.8, 0.16	0.8, 0.32	1	47.4

*The preparation is for 1 g of milk sample. The total volume of the final samples is 50 mL.

Add the appropriate amount of DI water to bring the volume of each sample to 49 mL (Table 1), shake, and put in an ultrasonic bath for 10 min. Add 1 mL of 3% acetic acid and shake to precipitate protein. Let the sample sit for 20 min. Use a 3 mL syringe to remove 3 mL of sample solution and filter with a 0.45 µm syringe filter washed with DI water before use. Discard the first 1.5 mL of sample and collect the remaining sample into a 1.5 mL glass vial. Rinse the vials with DI water prior to adding sample. The sample solutions to which known amounts of standard are added are referred to as Spiked 1, Spiked 2, Spiked 3, and Spiked 4. Sample solution without added standard solution is referred to as Unspiked.

Spiked Sample Preparation for Recovery and MDL Studies

Prepare spiked samples for recovery and MDL studies in the same manner as described above. For the recovery study, prepare the spiked sample to yield the same concentration as Spiked 1. Due to the nitrate present in the sample, spike only nitrite into the sample for the MDL study. Spike in an amount to yield 0.01 mg/L after preparation.

Table 2. Gradient Program and Valve Switching

Time (min)	Eluent Conc. (mM)	InjectValve_1	InjectValve_2	Remark
-20.0	50	Inject	Inject	Wash column and concentrator
-7.1	50	Inject	Inject	
-7.0	7	Inject	Load	
-5.0	7	Load, Inject*	Load	Load sample and then begin in-line sample preparation
0.0	7	Inject	Inject	Begin separation
25.0	7	Inject	Inject	
25.1	50	Inject	Inject	

*InjectValve_1 is controlled by the AS so that the program clock will be held during loading of the sample into the sample loop. After loading, InjectValve_1 is immediately switched to the inject position and the program resumes.

CHROMATOGRAPHIC CONDITIONS

Column: IonPac AS20 Analytical, 4 × 250 mm (P/N 063148)
 IonPac AG20 Guard, 4 × 50 mm (P/N 063154)
 InGuard: InGuard* HRP, 9 × 24 mm (P/N 074034)
 Concentrator: IonPac UTAC-LP1, 4 × 35 mm (P/N 063079)
 Eluent Source: EGC II KOH (P/N 058900) with CR-ATC (P/N 060477)
 Gradient: See Table 2
 Flow Rate: 1.0 mL/min
 Sample Volume: 25 µL
 Column Temp.: 30 °C (both zones of the DC are set to 30 °)
 Detection: Suppressed conductivity ASRS® 300, 4 mm (P/N 064554), External water mode (AXP flow rate 1 mL/min), 125 mA

*Prewash the InGuard cartridge in the IC system with water for a few minutes before use.

RESULTS AND DISCUSSION

Milk is a challenging sample because it has high concentrations of protein and fat. The protein can consume column capacity and interfere with the detection of nitrite and nitrate either by suppressed conductivity or UV absorbance detection. The fat can damage the column by a number of mechanisms including the generation of excessive backpressure. Therefore, removing the protein and fat from the sample is required for a successful application and for extending column lifetime. In traditional sample treatment, off-line sample treatment with an OnGuard® RP cartridge should be done before sample injection. There are some disadvantages to off-line sample treatment. It requires analyst time and the sample can be contaminated. OnGuard cartridges are designed for a single use and, therefore, each study requires multiple cartridges. InGuard cartridges are designed for on-line sample treatment during which multiple injections can be made on a single InGuard cartridge. With on-line sample preparation, analyst time is reduced, sample contamination is minimized, and the cost of sample analysis is reduced.

In this application, protein was first precipitated using acetic acid and then fat was removed on-line with an InGuard HRP cartridge. The goal was to have the InGuard cartridge last for at least 50 sample injections. In this study, the InGuard cartridge was changed after 100 milk sample injections (previously treated with acetic acid). The InGuard cartridge was changed before failure to ensure that the column was protected. Without protein precipitation prior to sample injection, high backpressure caused the InGuard cartridge to fail after less than 50 injections, and the chromatography was compromised by a noisy baseline. The goal of this challenging application was to have the column set withstand 500 sample injections before failure. With this sample treatment, approximately 1000 milk sample injections were made before nitrite had too great a loss of retention to be resolved from other peaks. Figure 1 shows the loss of retention time of nitrite and nitrate after approximately 800 sample injections, which still yielded acceptable resolution of nitrite from the unknown peak.

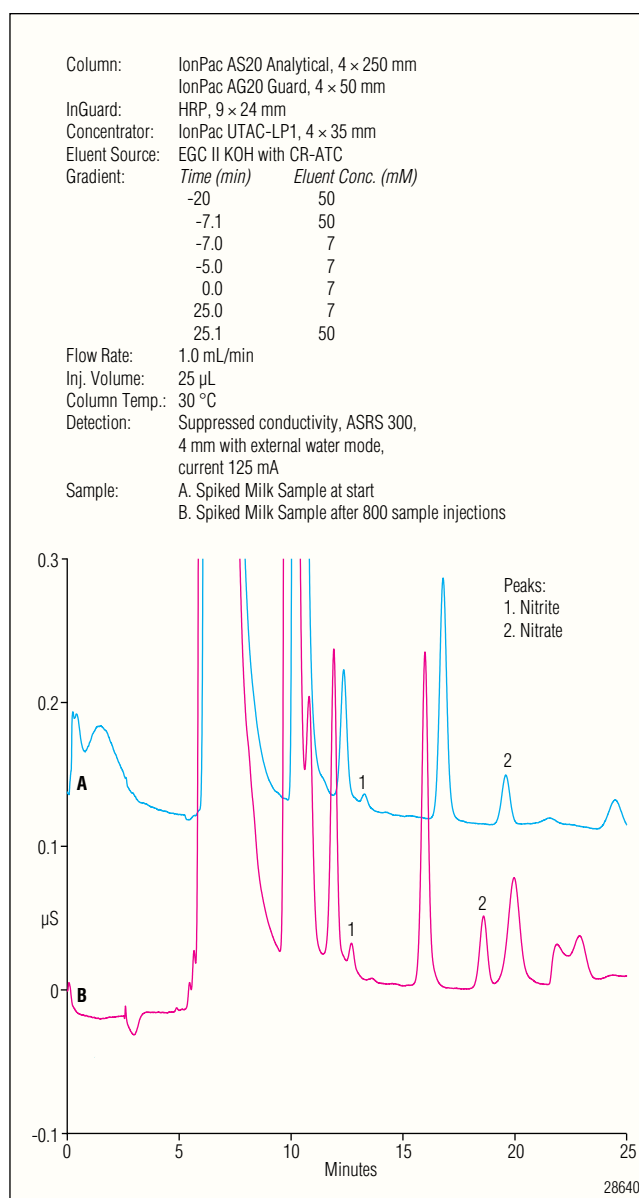

Figure 1. Chromatogram of Spiked Milk Sample #2 at the start and after 800 sample injections.

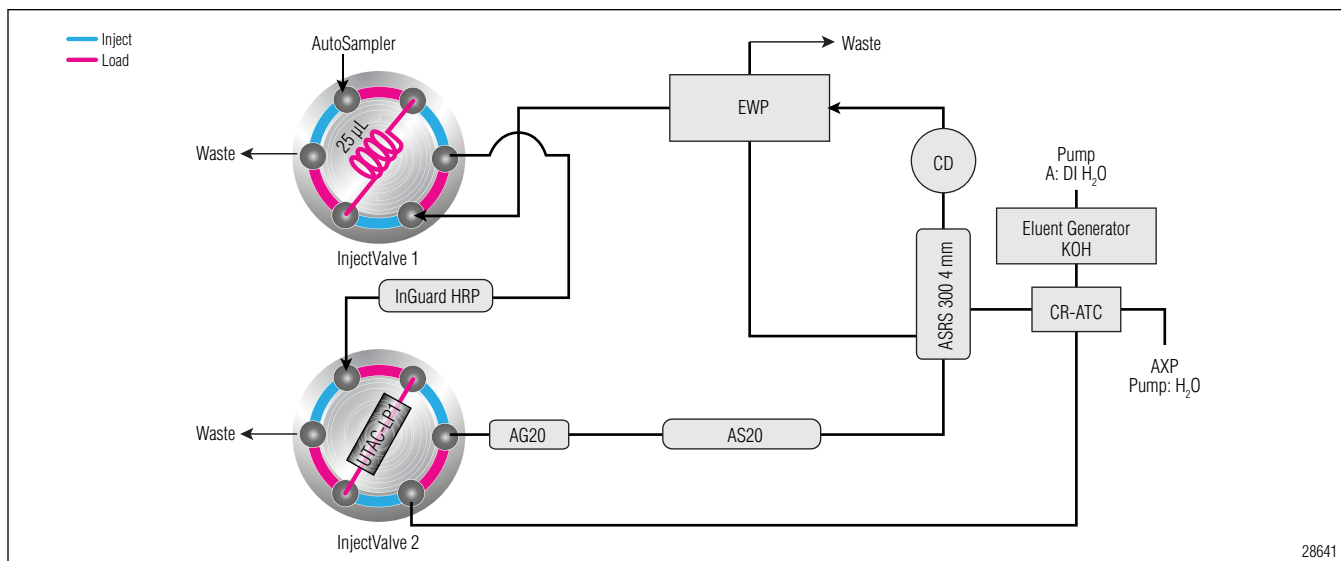

Figure 2. System configuration (both valves are in the load position).

Figure 2 shows the configuration of the system. After protein precipitation with 3% acetic acid, 25 µL of the sample were injected. Water from the outlet of the conductivity cell, purified by the EWP, was used to flush the sample from the sample loop to the InGuard cartridge. The sample compounds not bound by the InGuard cartridge, including nitrite and nitrate, were collected on the concentrator. The concentrator was then eluted onto the IonPac AS20 column set to separate nitrite and nitrate from the other bound sample components. Other hydroxide selective columns—including the IonPac AS11, AS11-HC, AS15, AS18, and AS19 columns—were tested, but the resolution on the AS20 column and its high capacity made it the most suitable column for this application.

To achieve the highest retention time reproducibility, this application was configured on an RFIC system. This system eliminates the labor and possible error of manual hydroxide eluent preparation. After a sample injection, the column and concentrator must be washed with 50 mM KOH for 13 min. This will remove the anionic compounds that were not eluted during the separation. The suppressed conductivity detection was configured with external water mode so that the effluent from the conductivity cell could be a source of water to move the sample from the sample loop to the InGuard cartridge.

When this configuration is used to execute the method in Table 2 on a blank sample (the acetic acid used for protein precipitation), the result is shown in Figure 3. The large peak between approximately 6 and 11 min is

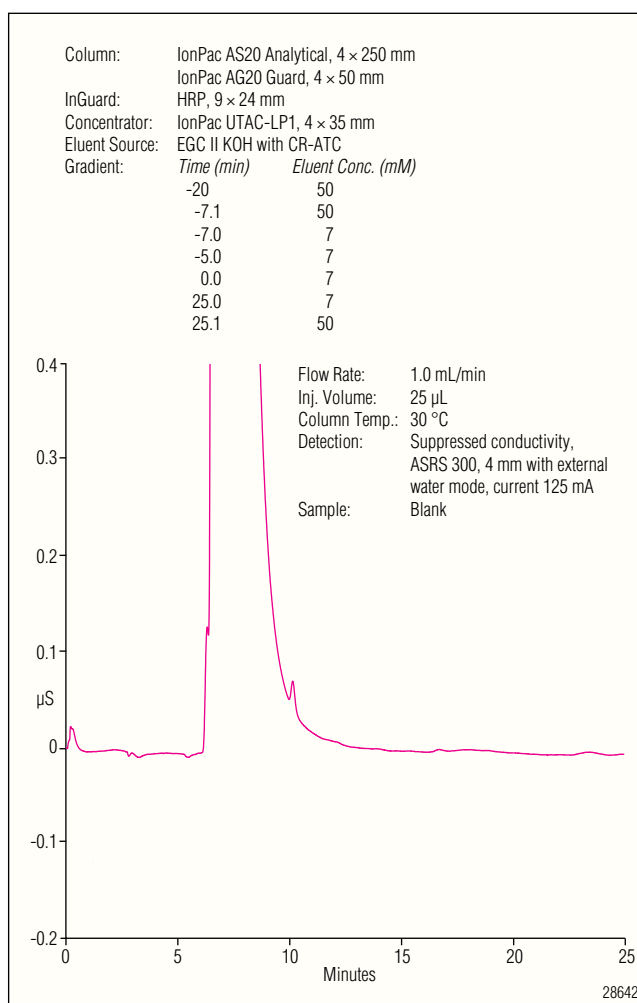

Figure 3. Chromatogram of an acetic acid blank.

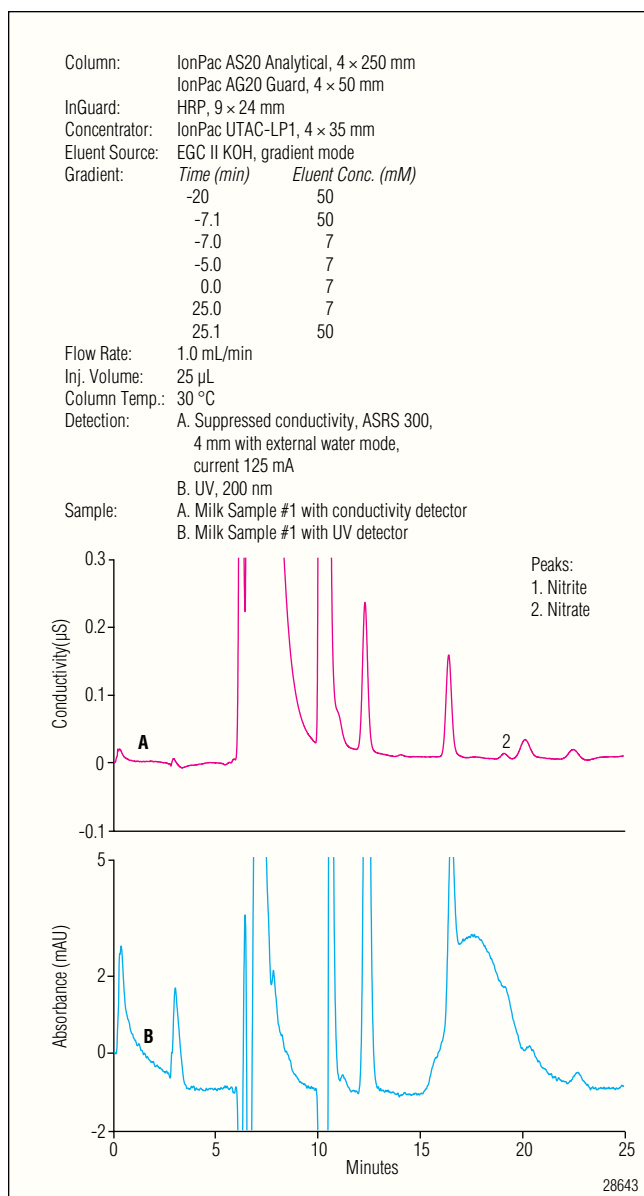

Figure 4. Overlay of chromatograms of Milk Sample #1 with (A) suppressed conductivity detection and (B) UV detection.

acetate, which does not interfere with nitrite or nitrate detection. A UV detector is placed after the conductivity detector to determine the best mode of detection for this analysis. Figure 4 shows chromatograms of Milk Sample #1 with conductivity and UV detections. The nitrate present in Sample #1 is difficult to determine with the UV detector, whereas it is readily determined by the conductivity detector.

This study showed that column temperature control is important to the success of this application. Specifically, if the column temperature was too high, the desired separation was not achieved. Figure 5 shows the effect

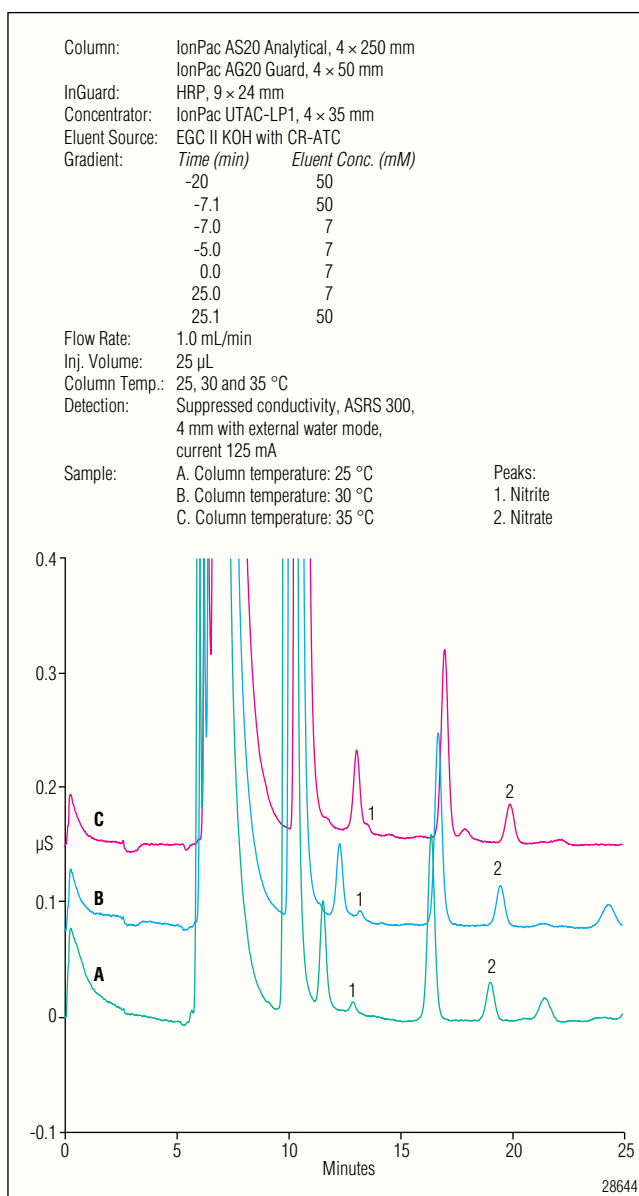

Figure 5. Overlay of chromatograms of prepared Milk Sample #2 analyzed at different column temperatures.

of column temperature on the separation of nitrite and nitrate in milk. At 35 °C, nitrite co-elutes with an unknown peak in the milk sample. For the remainder of the study, the column temperature was set at 30 °C, but 25 °C also yielded a good separation. These separation conditions were successful for the two samples studied. Some milk samples may require an adjustment of eluent concentration and/or column temperature to resolve nitrite and/or nitrate from unknown sample components.

6 Time Savings and Improved Reproducibility of Nitrate and Nitrite Ion Chromatography Determination in Milk Samples

Table 3. Calibration Results

Analyte	Sample #1				Sample #2			
	Points	r ²	Offset	Slope	Points	r ²	Offset	Slope
Nitrite	4	0.9990	-0.0002	0.1463	4	0.9991	-0.0008	0.1224
Nitrate	5	0.9995	0.0023	0.1268	5	0.9993	0.0101	0.1189

The method of standard additions was chosen for this application. Calibration standards were prepared in the sample and the added standard concentration was plotted versus the measured signal. Using this calibration curve, the amount of endogenous analyte in the sample can be determined. Two brands of milk purchased in a local supermarket are referred to as Sample #1 and Sample #2. Figure 6 shows the calibration chromatograms obtained for Sample #1 (chromatography of the calibration for Sample #2 is similar to Sample #1). Table 3 shows calibration results for both samples.

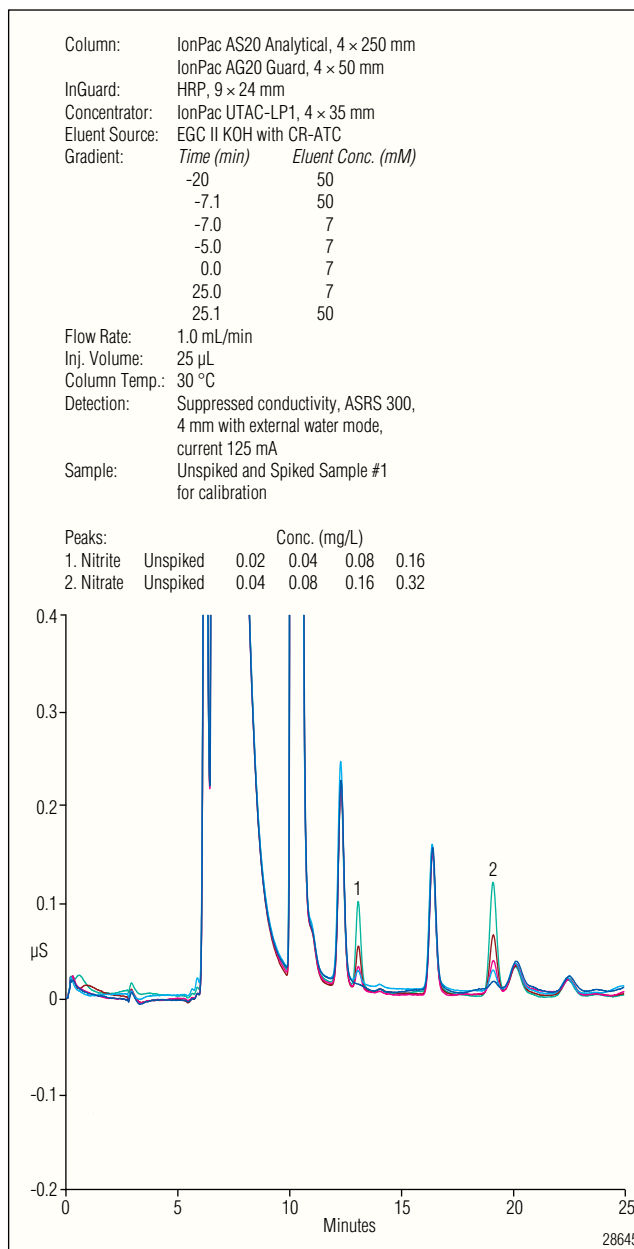

Figure 6. Overlay of five chromatograms of calibration standards of Sample #1 (chromatography of calibration standards for Sample #2 is similar).

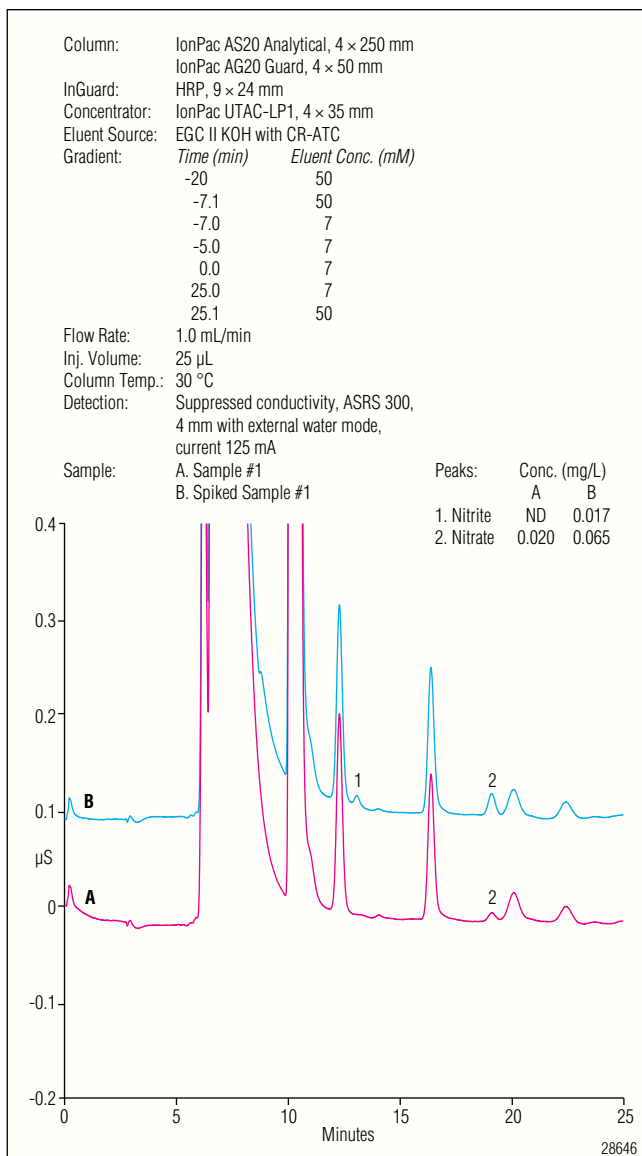

Figure 7. Overlay of chromatograms of Sample #1 and Spiked Sample #1.

To evaluate recovery, spiked samples were prepared to yield known concentrations of 0.02 mg/L nitrite and 0.04 mg/L nitrate; recoveries were calculated using the calibration curves prepared for each samples. Nitrate was found at 0.020 and 0.084 mg/L in Samples #1 and #2, respectively, and nitrite was absent in both samples.

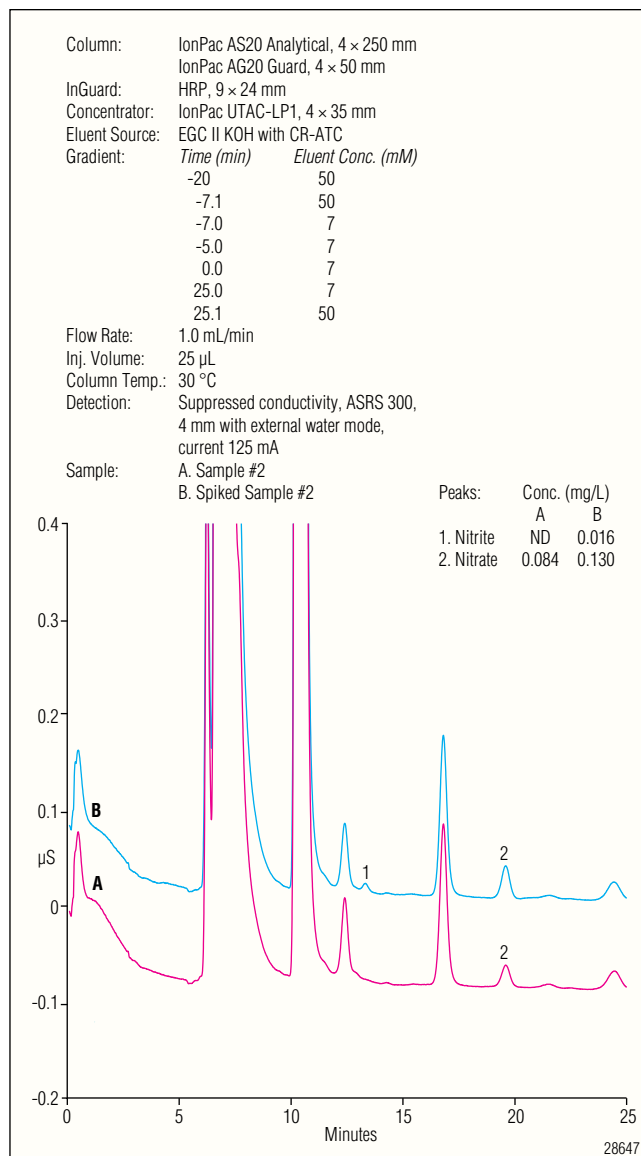

Figure 8. Overlay of chromatograms of Sample #2 and Spiked Sample #2.

Figures 7 and 8 show the chromatography from the spike recovery experiments. Note the difference in the number, size, and retention times of the unknown peaks in Samples #1 and #2. This again suggests that chromatography may need to be optimized for individual milk samples.

Table 4. Concentrations of Nitrite and Nitrate Determined in Sample #1, Spiked Sample #1, Sample #2, and Spiked Sample #2

Injection No.	Concentration in Milk Sample #1 (mg/L)				Concentration in Milk Sample #2 (mg/L)			
	Sample		Spiked Sample (Spiked 0.02 mg/L Nitrite and 0.04 mg/L Nitrate)		Sample		Spiked Sample (Spiked 0.02 mg/L Nitrite and 0.04 mg/L Nitrate)	
	Nitrite	Nitrate	Nitrite	Nitrate	Nitrite	Nitrate	Nitrite	Nitrate
1	ND	0.021	0.016	0.065	ND	0.084	0.016	0.126
2	ND	0.022	0.017	0.065	ND	0.085	0.016	0.127
3	ND	0.019	0.017	0.065	ND	0.084	0.016	0.135
Average	ND	0.020	0.017	0.065	ND	0.084	0.016	0.130
RSD f	ND	6.29	2.87	0.18	ND	0.93	2.84	3.81
Recovery (%)	—	—	84.0	111	—	—	80.0	113

The sample analysis and recovery results are shown in Table 4. To assess method sensitivity, the method detection limit (MDL) was determined. Due to the nitrate present in the sample, only nitrite was spiked into the sample to yield a concentration of 0.01 mg/L. The endogenous concentration of nitrate was used to estimate the MDL. Seven injections were made and the single-sided Student's *t* test at a 99% confidence level used to estimate the MDLs. This resulted in MDLs for nitrite and nitrate of 0.002 mg/L and 0.005 mg/L, respectively. During this study, the conductivity background and baseline noise were approximately 0.37 μ S and 0.25 nS, respectively. Chromatography of one of the seven injections from the MDL study is shown in Figure 9.

CONCLUSION

This application demonstrates the determination of nitrite and nitrate in milk by IC with suppressed conductivity detection using in-line sample preparation. This method uses a simple acid precipitation followed by additional in-line automated sample preparation to prepare the sample prior to chromatography. The prepared sample is separated on the high-capacity IonPac AS20 column to resolve nitrite and nitrate from the remaining sample components. The RFIC system automatically prepares the separation eluent to achieve high separation reproducibility. The automated sample and eluent preparation saves time and improves the reproducibility of the analysis.

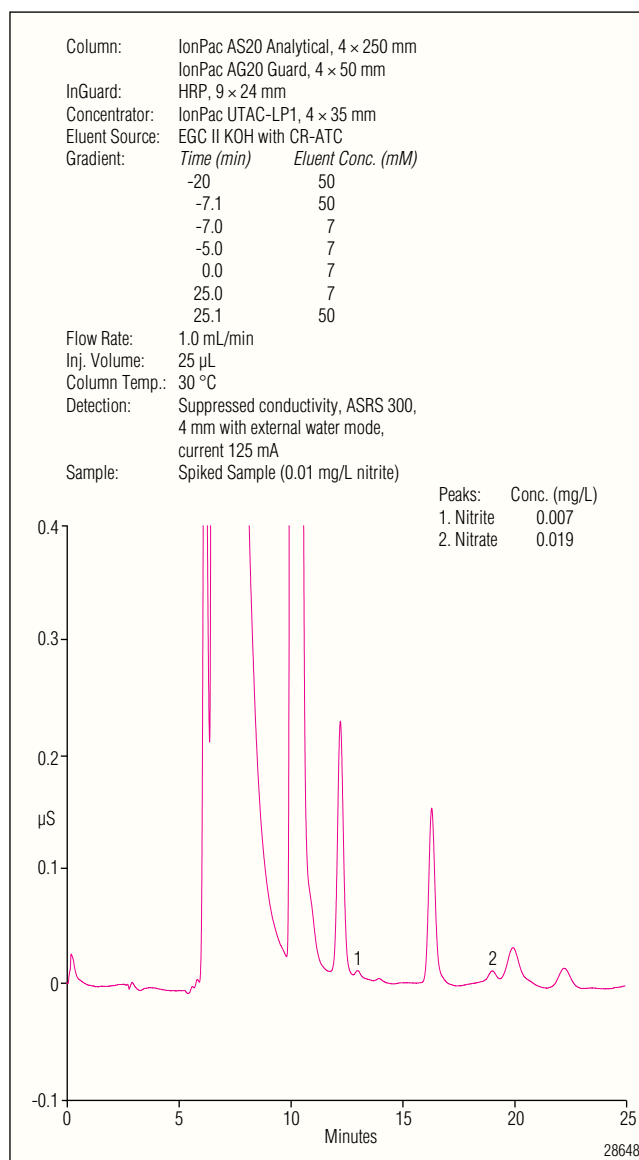

Figure 9. Chromatogram of a spiked sample for the MDL study.

REFERENCES

1. *Nitrates and Nitrites, TEACH Chemical Summary*, United States Environmental Protection Agency. http://www.epa.gov/teach/chem_summ/Nitrates_summary.pdf (accessed April 21, 2011).
2. *The Determination of Inorganic Anions in Water by Ion Chromatography*; Method 300.0; United States Environmental Protection Agency: Cincinnati, Ohio, 1993.
3. Dionex Corporation, *Determination of Nitrite and Nitrate in Drinking Water Using Ion Chromatography with Direct UV Detection*. Application Update 132, LPN 034527, 1991, Sunnyvale, CA.

InGuard, IonPac, Chromeleon, ASRS, and OnGuard are registered trademarks, and Reagent-Free and RFIC are trademarks of Dionex Corporation.

Speed • Simplicity • Solutions

Dionex Corporation

1228 Titan Way
P.O. Box 3603
Sunnyvale, CA
94088-3603
(408) 737-0700

North America

U.S./Canada (847) 295-7500

South America

Brazil (55) 11 3731 5140

Europe

Austria (43) 1 616 51 25 Benelux (31) 20 683 9768 (32) 3 353 4294
Denmark (45) 36 36 90 90 France (33) 1 39 30 01 10 Germany (49) 6126 991 0
Ireland (353) 1 644 0064 Italy (39) 02 51 62 1267 Sweden (46) 8 473 3380
Switzerland (41) 62 205 9966 United Kingdom (44) 1276 691722

Asia Pacific

Australia (61) 2 9420 5233 China (852) 2428 3282 India (91) 22 2764 2735
Japan (81) 6 6885 1213 Korea (82) 2 2653 2580 Singapore (65) 6289 1190
Taiwan (886) 2 8751 6655

www.dionex.com



LPN 2830 PDF 05/11
©2011 Dionex Corporation