

Errata

Product Manual for Dionex IonPac™ AC15 Concentrator Columns
031593-02

For new orders of the following parts discussed in this manual, please use the updated part numbers listed below.

Part	Old Part Number in this manual	Updated Part Number to use for new orders
<i>PROD,COL,IP,AC15,4X50MM</i>	<i>055694</i>	<i>079970</i>



PRODUCT MANUAL

IONPAC® AC15 CONCENTRATOR COLUMN

(4 x 50 mm, P/N 055694)

(2 x 50 mm, P/N 055695)

QUICKSTART STEPS AND LINKS

Click blue text below to get started.

1. See [Section 2, "Installation"](#) for IonPac AC15 Concentrator Column installation instructions.
2. See [Section 3, "Operation"](#) for IonPac AC15 Concentrator Column operation instructions.

Now sold under the
Thermo Scientific brand

Thermo
SCIENTIFIC

Part of Thermo Fisher Scientific

©DIONEX Corporation, 1999, 2002

Document No. 031593

Revision 02

5 November 2002

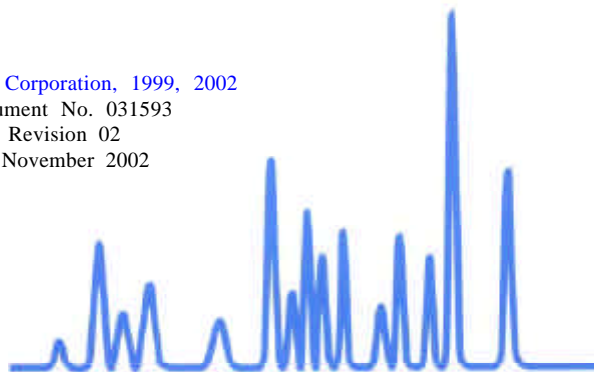

TABLE OF CONTENTS

SECTION 1 - INTRODUCTION	3
SECTION 2 - INSTALLATION	4
2.1 Column Description	4
2.2 System Requirements for the IonPac AC15 Concentrator Column	4
SECTION 3 - OPERATION	5
3.1 Sample Loading	5
3.2 Reagent and Sample Handling	5
3.2.1 Water Quality	5
3.2.2 Sample Collection and Storage	6
3.2.3 Standards	6
3.3 Concentrator Capacity	6
3.3.1 Capacity Considerations for Concentrators	6
3.3.2 Determination of Concentrator Column Breakthrough Volume	8
SECTION 4 - TROUBLESHOOTING GUIDE	10
4.1 High Back Pressure from a Contaminated Inlet Bed Support	10
4.2 Poor Recovery of Analytes	11
4.3 High Background, Noise or Baseline Instability	11

SECTION 1 - INTRODUCTION

The IonPac® AC15 Concentrator Column is designed primarily for high purity water analysis. The function of the AC15 is to strip ions from a measured volume of a relatively clean aqueous sample matrix. This process “concentrates” the desired analyte species onto the AC15 leading to a lowering of detection limits by 2-5 orders of magnitude. The unique advantage of the AC15 to the analytical chemist is the capability of performing routine trace analyses of sample matrix ions at µg/L - ng/L levels without extensive and laborious sample pretreatment.

For trace level analysis, the sample loop on the injection valve of the Ion Chromatograph is replaced with the AC15. A sample loading pump is required to pump sample through the AC15. The AC15 has been optimized for use with the IonPac AS15 Analytical Column to effectively concentrate anions from deionized water and high purity power plant waters. Sample volumes of 100 mL or more may be concentrated, depending on the matrix, to achieve detection limits for parts per trillion determinations. Concentrator column breakthrough volume needs to be determined (See Section 3.3.7).

The AC15 is packed with a solvent compatible, microporous ethylvinylbenzene/divinylbenzene resin that is coated with a quaternary amine functionalized latex. The capacity of the AC15 (4 x 50 mm) is 10 µeq/column with a void volume of approximately 150 µL. The physical rigidity of this resin allows the AC15 to be used at pressures up to 4,000 psi. The AC15 can be readily converted between the hydroxide and the salt form without significant changes in the operating pressure and is compatible with samples containing organic solvent. The recommended maximum flow rate is 3 mL/min for the AC15 4-mm.

The AC15 is available in a 2 x 50 mm format for operation with the IonPac AS15 2-mm and 3-mm Analytical Columns. This concentrator has been optimized to minimize the dead volume contributed by the concentrator during 2-mm and 3-mm operation. The recommended maximum flow rate is 1.25 mL/min for the AC15 2-mm and 3-mm. For more information on the installation and operation of 2-mm and 3-mm columns, see the Product Manual for the IonPac AS15 and AG15 (Document No. 031362).

The IonPac AS15, AG15 and AC15 Columns have 10-32 PEEK end fittings for use with ferrule/bolt liquid line fittings. If you have an Ion Chromatograph with Tefzel® liquid lines having 1/4-28 ThermoFlare fittings, it will be necessary to obtain one or more Tefzel liquid lines with a PEEK bolt and ferrule fitting on one end and a 1/4-28 ThermoFlare fitting on the other end. See “Installation of DIONEX Liquid Line Fittings,” for detailed instructions on purchasing or making these lines.

Table 1
IonPac AC15 Trap Column Packing Specifications

Column	Particle Diameter µm	Substrate X-Linking %	Latex Diameter nm	Latex X-Linking %	Column Capacity µeq/column	Functional Group	Hydrophobicity
IonPac AC15 4-mm	13	55	85	6	9	Alkanol Quaternary Ammonium	Very Low
IonPac AC15 2-mm	13	55	85	6	2.2	Alkanol Quaternary Ammonium	Very Low

Table 2
IonPac AC15 Trap Column Operating Parameters

Column	Typical Back Pressure psi (MPa)	Standard Flow Rate mL/min	Maximum Flow Rate mL/min
IonPac AC15 Trap Column 4-mm	≤ 140 (0.96)	1.0	3.0
IonPac AC15 Trap Column 2-mm	≤ 160 (1.10)	0.42	1.25

Always remember that assistance is available for any problem that may be encountered during the shipment or operation of DIONEX instrumentation and columns through the DIONEX North America Technical Call Center at 1-800-DIONEX-0 (1-800-346-6390) or through any of the DIONEX Offices listed in, “DIONEX Worldwide Offices.”

SECTION 2 - INSTALLATION

For information on the general installation of concentrator columns in a variety of systems, see DIONEX Technical Note No. 8, "The Use of Concentrator Columns in Ion Chromatography."

2.1 Column Description

The IonPac AC15 Concentrator Column consists of the following components:

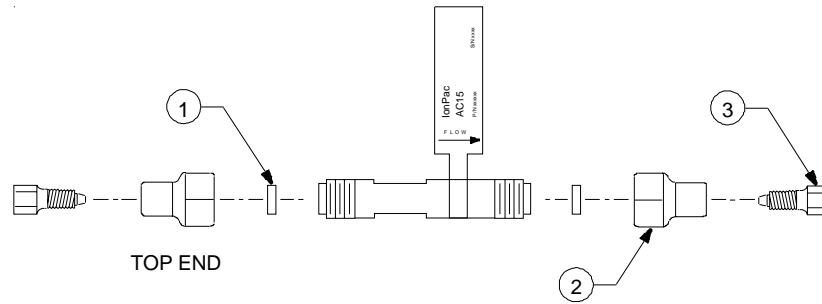

1. Bed Support Assembly
 2. 10-32 Ferrule Column End Fitting
 3. 10-32 Ferrule Plug
- (See Section 4.1, "High Back Pressure from a Contaminated Bed Support" for hardware part numbers)

Figure 1

AC15 Column Components

2.2 System Requirements for the IonPac AC15 Concentrator Column

Figure 2, "Configuration for Determining Trace Levels of Anions," shows the generalized flow schematic for trace level anion chromatography.

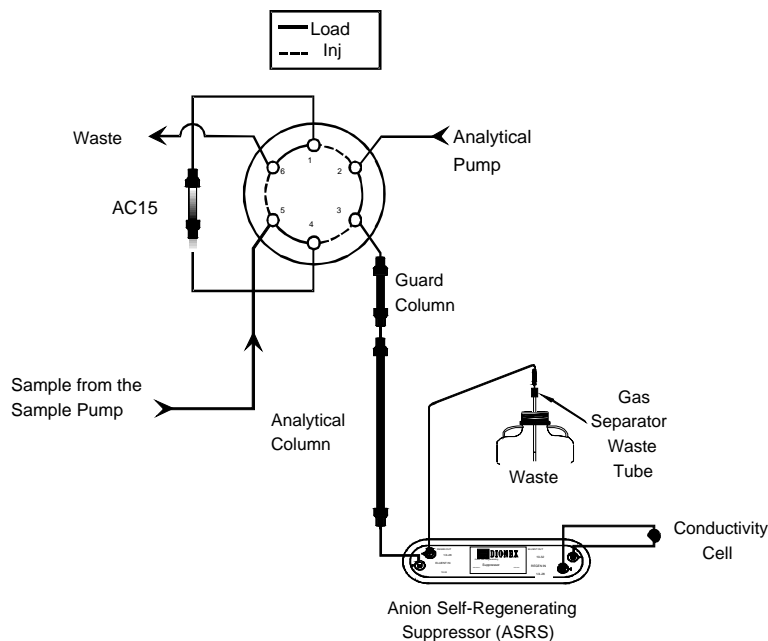

Figure 2

Configuration for Determining Trace Levels of Anions

SECTION 3 - OPERATION

3.1 Sample Loading

Sample loading is performed with a separate positive displacement pump such as the DIONEX DQP pump (P/N 035250), DXP Pump (P/N 043047) or the Reagent Pump (P/N 042043). Pump flow rates of approximately 3 mL/min can be used while maintaining sample concentration efficiencies high enough to ensure good quantification. To prevent overloading of the AC15 and/or the loss of sample analytes, concentration linearity over the desired analytical concentration range should be determined (see Section 3.4.1, “Capacity Considerations for Concentrators”).

The flow direction during the concentration step is critical. After the sample has been loaded onto the AC15 in the direction opposite to the eluent flow, it is then “backflushed” with eluent onto the guard and analytical columns (see Figure 3, “Loading the IonPac AC15 Concentrator Column”). This configuration concentrates the anions in a compact band at the bottom of the AC15. When the valve is switched for injection, all of the ions are rapidly eluted off the AC15 and onto the guard and analytical columns.

If the sample is loaded onto the AC15 in the same flow direction as the eluent flow, the anions are concentrated at the head of the column rather than at the bottom. When injected, the anions begin chromatographic separation on the concentrator before reaching the guard and analytical columns. Normally the function of the concentrator is to strip the ions of interest from the sample matrix and not to act as an analytical column. In order to ensure maximum system performance, it is recommended that concentration always be performed in a “backflush” manner.

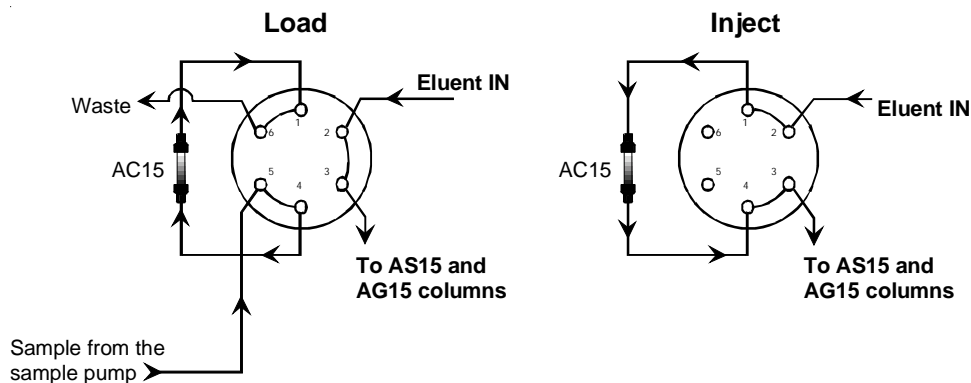

Figure 3

Loading the IonPac AC15 Concentrator Column

3.2 Reagent and Sample Handling

The use of the IonPac AC15 Concentrator Column has certain limitations. At trace analyte concentration levels ($\mu\text{g/L}$), the results of the analysis depend on carefully following good laboratory practices. All sources of contamination must be eliminated. The following sections focus on critical points that must be observed when using concentrator columns. Proper consideration of these points will enable the analyst to obtain accurate and reproducible results for trace analyte concentrations.

3.2.1 Water Quality

All water used in the preparation of standards and eluents should be **Type I Reagent Grade Water** with a specific resistance of 18.2 megohm-cm. The quality of the dilution water must be determined by Ion Chromatography since even deionized water with a specific resistance of 18.2 megohm-cm may contain trace levels of the ions of interest. To do this, analyze your water in exactly the same manner as you would your sample.

3.2.2 Sample Collection and Storage

At trace analyte concentration levels (where, $1 \mu\text{g/L} = 1 \text{ ppb}$), chances of contamination during collection or storage are high. Every container and every procedural step constitutes a potential source of contamination. Polystyrene containers with leak-tight caps can be used to store 1 to $5 \mu\text{g/L}$ levels of inorganic and organic anions for up to 8 days. Recommended storage vessels are Corning tissue culture flasks (should not have cap seal). The following procedure should be used for storage of $\mu\text{g/L}$ level samples.

Use gloves for critical work.

- A. Rinse the polystyrene container and cap twice with deionized water having a specific resistance of 18.2 megohm-cm. Fill the container until it overflows, cap it securely, and soak for 4 hours.
- B. Empty the container and refill it with deionized water having a specific resistance of 18.2 megohm-cm. Cap the container securely. It should remain filled at least 24 hours before sample collection.
- C. Empty the container and rinse it twice with the sample to be collected. Fill the container with the sample until it overflows and then cap the container securely.

NOTE

Never use plastic syringes with rubber pistons for any loading of trace ions. These materials cause non-reproducible results.

3.2.3 Standards

It is good practice to run standards at the beginning, middle, and end of each day to ensure constant instrument response. Because external standard quantification is used, it is critical that standard solutions are correctly prepared.

- A. 1,000 mg/L stock standard solutions should be prepared by accurately weighing amounts of salts as described in your instrument manual. These solutions are stable over a period of several months when refrigerated.
- B. 1 mg/L stock standard solutions may be prepared by diluting 1 mL of 1,000 mg/L stock standard to 1,000 mL in a volumetric flask. These solutions should then be transferred to clean polystyrene containers. They may be stored for one month if refrigerated.
- C. $1 \mu\text{g/L}$ working standard solutions may be prepared by diluting 1 mL of the 1 mg/L stock standard to 1,000 mL. These working standards are stored in polystyrene containers. They are stable up to 8 days but it is recommended that they be prepared daily since standard response is critical in the results of your analysis.

3.3 Concentrator Capacity

3.3.1 Capacity Considerations for Concentrators

As in all ion exchange systems, the resin has a finite capacity. It can strip a given amount of ions from water. When the capacity of the concentrator is exceeded, the stripping will not be quantitative. This condition is referred to as column overload. The presence of any anionic component can contribute to column overload.

When estimating the capacity of a concentrator, one must remember that the column is used in a dynamic state where the liquid containing the analytes is flowing over the resin at a finite rate. This reduces the capacity since the analyte ions have less time to interact with the resin surface.

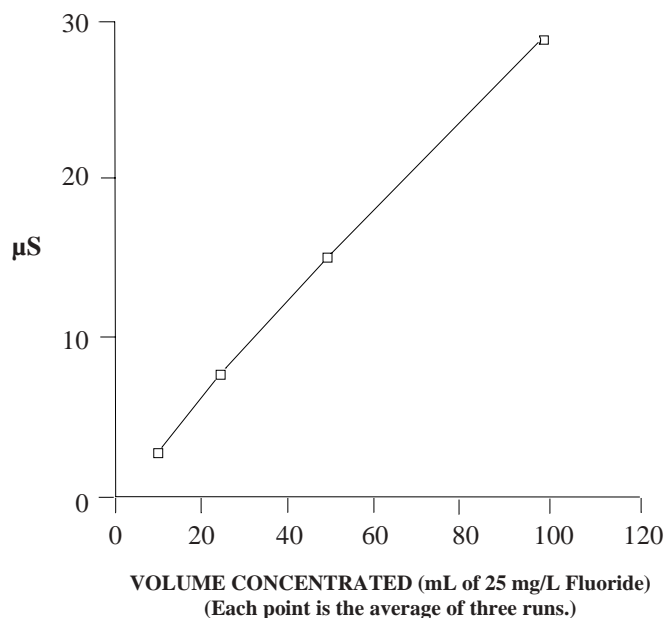

Figure 4

Response versus Volume Concentrated

Low concentrator column capacity creates the following practical implications:

- A. Trace analysis of an analyte is difficult in the presence of mg/L concentrations of species which exhibit higher or similar affinities for the resin (e.g. SO_4^{2-} , NO_3^- , S^{2-} , OH^- , etc.). If the dynamic column capacity is exceeded, high affinity ions will displace the weakly retained analytes on the ion exchange sites and result in their elution to waste during the loading process.

NOTE

At higher concentrations, all ions which are ion-exchanged on the resin may be potential sources of interference. This includes ions which are not detected by the conductivity detector (e.g., S^{2-} , OH^- , CN^-). The dynamic column capacity should serve as a guideline in evaluating potential interferences.

- B. Conversely, qualitative analysis of ions with higher affinities for the resin in the presence of high concentrations of ions with low affinities is possible (e.g., analysis of SO_4^{2-} in the presence of high concentrations of F^- or acetate). Again, the key to successful analysis is that the total ionic content of the sample may not exceed the effective column capacity.
- C. Do not dilute samples to be concentrated in eluent because the eluent ions elute the ions of interest from the AC15 Concentrator.
- D. A plot of response versus volume concentrated, similar to Figure 4, "Response versus Volume Concentrated," should be generated for determination of the maximum amount of sample or standards that can be quantitatively loaded. The curve loses linearity above 100 mL volume concentrated. Therefore volume greater than 100 mL should not be used for quantification. For practical purposes the volume concentrated for this series of samples should be 75% of this value. This will ensure that there is a safety margin for samples in the series having slightly higher ionic concentrations. See Figure 4, "Response versus Volume Concentrated."

3.3.2 Determination of Concentrator Column Breakthrough Volume

The breakthrough volume of an analyte ion is that volume of sample which causes an ion of interest to be eluted from, rather than remain retained or concentrated on, the concentrator column.

The breakthrough is dependent upon the following:

- A. The volume of sample loaded
- B. The rate at which the sample is loaded
- C. The pH of the sample
- D. The ionic strength of the sample
- E. The amount and capacity of resin in the column

The breakthrough volume is determined as follows:

- A. Prepare 1 L of a solution that closely simulates the type of sample to be analyzed.** For example, if the sample contains high levels of ammonia, the simulated sample should also contain ammonia. Ammonia in typical solutions usually exists as ammonium hydroxide ions. The resulting hydroxide ion will act as an eluent.
- B. Prepare a 1 mg/L standard of the first eluting ion of interest (e.g., F⁻).**
- C. Set up the Ion Chromatograph,** as shown in Figure 5, “Instrument Setup for the Determination of the Breakthrough Volume,” and equilibrate the concentrator column with eluent at the concentration flow rate needed to achieve a stable baseline.
- D. Switch to the simulated sample as an eluent and manually inject a 50 µL portion of the 1 mg/L standard.**
- E. Record the resulting chromatogram and calculate the breakthrough volume,** as shown in the example in Figure 6, “Example Determination of the Breakthrough Volume.”
- F. For practical purposes, the volume concentrated should be below 75% of the breakthrough volume.

NOTE

Additional information on breakthrough can be found in DIONEX Technical Note No. 8, “The Use of Concentrator Columns in Ion Chromatography.”

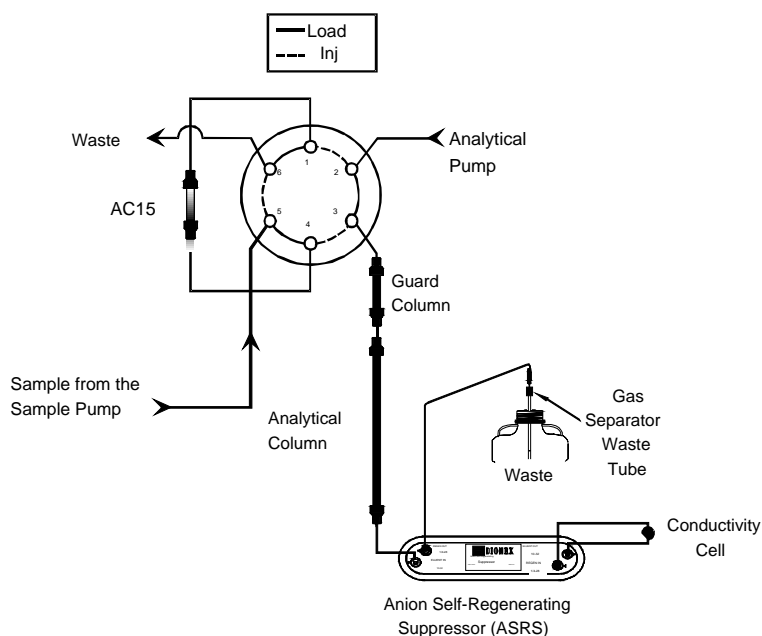

Figure 5

Instrument Setup for the Determination of the Breakthrough Volume

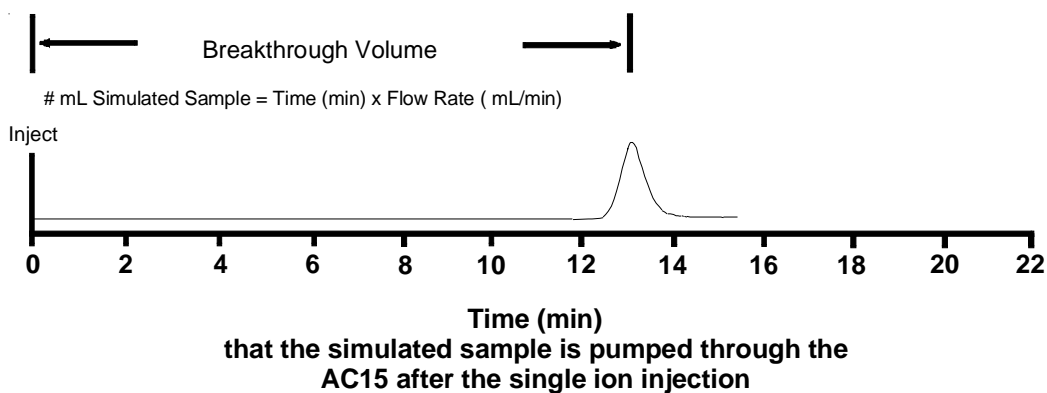

Figure 6

Example Determination of the Breakthrough Volume

SECTION 4 - TROUBLESHOOTING GUIDE

The purpose of the Troubleshooting Guide is to help you solve operating problems that may arise while using the IonPac AC15 Concentrator Column. For more information on problems that originate with the Ion Chromatograph, refer to the Troubleshooting Guide in the appropriate operator's manual. If you cannot solve the problem on your own, call the nearest DIONEX Office (see, "DIONEX Worldwide Offices").

4.1 High Back Pressure from a Contaminated Inlet Bed Support

If the AC15 displays high back pressure, the bed support in the column inlet may be contaminated. Follow the instructions below to change the bed support assembly using one of the two spare bed support assemblies included in the ship kit provided with the column.

- A. **Disconnect the column from the system.**
- B. **Carefully unscrew the inlet (top) column end fitting**, using two open-end wrenches.
- C. **Remove the bed support.** Turn the end fitting over and tap it against a benchtop or other hard, flat surface to remove the bed support and seal assembly. If the bed support must be pried out of the end fitting, use a sharp pointed object such as a pair of tweezers, but be careful that you **DO NOT SCRATCH THE WALLS OF THE END FITTING**. Discard the old assembly.
- D. **Place a new bed support assembly in the end fitting.** Use the end of the column to carefully start the bed support assembly into the end fitting.

	IonPac AS15/AG15/AC15		
	4-mm Columns (P/N)	3-mm Columns (P/N)	2-mm Columns (P/N)
Analytical Column (AS15)	053940	057594	053941
Guard Column (AG15)	053942	057597	053943
Concentrator Column (AC15)	055694	055695	055695
Bed Support Assembly	043275	056823	044689
End Fitting	052809	052809	043278

- E. **Screw the end fitting back onto the column.** Tighten it fingertight and then using two open-end wrenches, tighten it an additional 1/4 turn (25 in x lb). Tighten further only if leaks are observed.

NOTE

If any of the column packing becomes lodged between the end of the column and the bed support washer assembly, no amount of tightening will seal the column. Make sure that the washer and the end of the column are clean before screwing the end fitting back onto the column.

- F. **Reconnect the column to the system and resume operation.**

4.2 Poor Recovery of Analytes

- A. Ensure that the sample volume does not exceed the recommended volume.
- B. Ensure that the sample flow rate does not exceed the recommended flow rate.
- C. Matrix components may reduce column capacity available to concentrate the analytes of interest.

4.3 High Background, Noise or Baseline Instability

Normally, problems such as high background, noise or baseline instability will not be attributable to the IonPac AC15 Concentrator Column. These problems usually originate in either the analytical column or the post-column detection method. Before checking the AC15 as the source of system background noise, consult the appropriate troubleshooting sections in the analytical column Product Manual, the Ion Chromatograph Operator's Manual and the detector manual.

If the source of the high background noise is isolated to the AC15, then proceed with the following steps:

- A. Make sure that the eluents and the regenerant concentrations are correctly formulated.**
 - B. Make sure that the eluents are made from chemicals with the recommended purity** (see Section 3, "Operation").
 - C. Make sure that deionized water used to prepare the reagents has a specific resistance of 18.2 megohm-cm.**
 - D. If you cannot solve the problem on your own, call the nearest DIONEX Office (see, "DIONEX Worldwide Offices").
-