

Thermo Scientific
BioLC Columns



Monoclonal antibody **characterization**

Innovative technologies and workflows
for increasing productivity and throughput

Thermo
SCIENTIFIC



Table of Contents

Characterization of Monoclonal Antibodies	3
Affinity Titer Determination of mAbs	6
Charge Variant Analysis Using Ion Exchange Chromatography.....	7
Size Exclusion Chromatography for Aggregate Screening	11
Hydrophobic Interaction Chromatography (HIC) in mAb Analysis.....	12
Analysis of Intact and Reduced Antibodies	13
Glycan Profiling for mAb Variant Characterization	15
Bringing Biomolecule Characterization Towards UHPLC.....	17
LC-MS Workflows for mAb Separation and Characterization	19
Ordering Information	21–23

Characterization of Monoclonal Antibodies

Protein and monoclonal antibody (mAb) biopharmaceuticals form a major part of the growing biologics drug market, and have been transforming the biotechnology and biopharmaceutical industries in the last decade. MAb treatment is amongst the most effective methods of diagnosis and treatment of a broad range of diseases, including autoimmune disorders, cardiovascular diseases, infectious diseases, cancer, and inflammation.

There is an extensive development pipeline for protein and mAb therapeutics, further emphasizing the need for innovative and efficient analytic tools. During development and production of these products it is essential to detect, characterize and quantify impurities as well as structural variants and modifications, and to monitor product stability. This is key to demonstrating safety and efficacy and is required by the U.S. FDA, EMEA, CFDA and other regulatory agencies.

Requirements for mAb Characterization

Protein Property	Technique Required for Characterization	Recommended Column	LC Technique Required for Batch Release	Recommended Column	Further Characterization Requirements	Recommended Column
Size	SEC MS (Intact Mass)	MABPac SEC-1	SEC	MABPac SEC-1	Impurities; Fragments/ Aggregates	MABPac SEC-1
Charge	IEC pH-IEC	MABPac SCX-10 MABPac SCX-10 RS pH Gradient Buffers	IEC pH-IEC	MABPac SCX-10 MABPac SCX-10 RS pH Gradient Buffers	Acylation, Deamidation, Sialylation Variants	MABPac SCX-10 MABPac SCX-10 RS
Hydrophobicity	HIC	ProPac HIC-10			Deamidation, Oxidation	ProPac HIC-10
Structural Characterization (2^o, 3^o Structure)	Reversed-Phase	ProSwift RP-2H ProSwift RP-4H			Disulfide Mapping	ProSwift RP-2H ProSwift RP-4H
Identification (Peptide Mapping)	Reversed-Phase	Accucore 150-C18 PepMap 100 C18	Reversed-Phase	Accucore 150-C18 PepMap 100 C18		
Glycan Analysis	Fluorescent Tags: Mixed Mode AX-HILIC Mixed Mode AX-Reversed Phase HILIC Native Glycans: Mixed Mode AX-HILIC Mixed Mode AX-Reversed Phase	GlycanPac AXH-1 GlycanPac AXR-1 Accucore Amide-HILIC GlycanPac AXH-1 GlycanPac AXR-1	 Mixed Mode AX-HILIC Mixed Mode AX-Reversed Phase HILIC	 GlycanPac AXH-1 GlycanPac AXR-1 Accucore Amide-HILIC	 Heterogeneity	 GlycanPac AXH-1 GlycanPac AXR-1

Physicochemical Characteristics

N-terminal heterogeneity

- Pyroglutamate formation

Amino acid modifications

- Deamidation, oxidation, glycosylation, isomerization

Fragmentation

- Cleavage in hinge region

Oligosaccharides

- Fucosylation, galactosylation, sialylation

Disulfide bonds

- Free thiols, disulfide shuffling, thioether

C-terminal heterogeneity

- Lysine processing, Proline amidation

Biological Characteristics

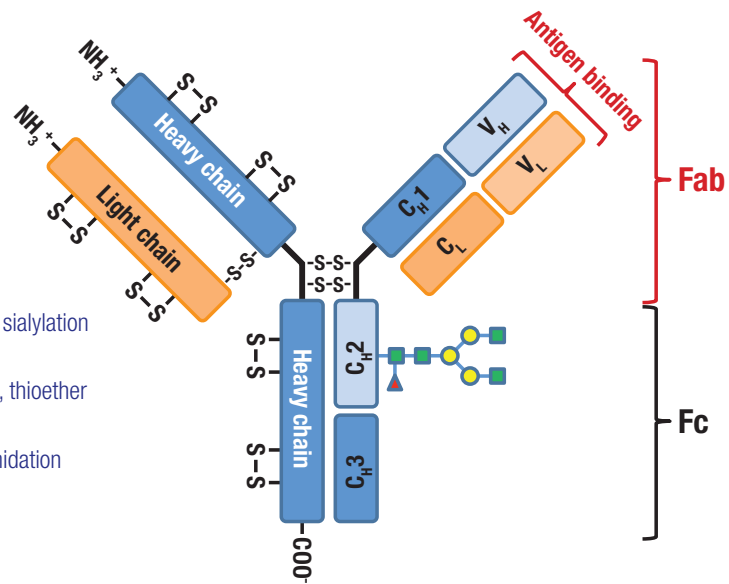

Monoclonal antibodies usually display complex microheterogeneity. With such potential for post-translational modifications (PTMs), quality control and stability assessment of monoclonal antibodies are very challenging tasks.

Liquid chromatography has established itself as an essential tool in the characterization of mAb biotherapeutics and others.

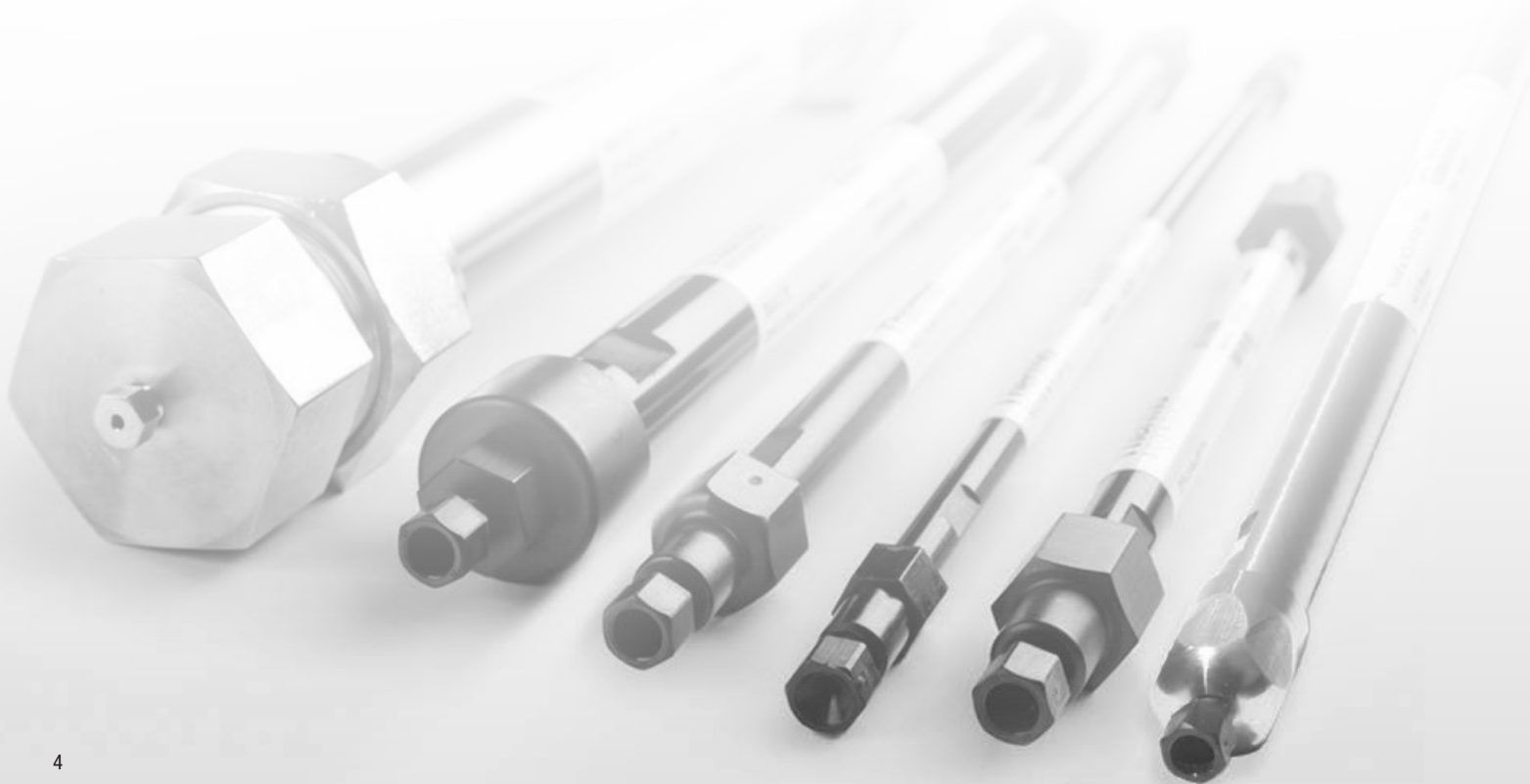

Typical mAb Characterization Workflow

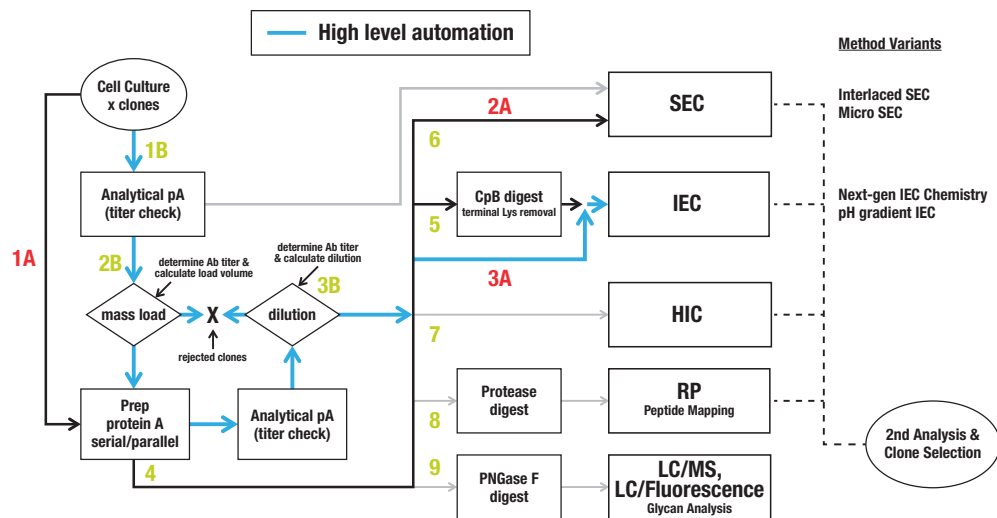

Purification of mAb or IgG from harvested cell culture fluid (HCCF) using Protein A is typically the first step (1A), followed by SEC for aggregate profiling (2A) and IEC for charge variants analysis (3A). For this reason, these separation modes make up a substantial portion of the analysis performed during mAb development.

Variations in the workflows usually include:

- Performing the initial IgG titer check by analytical Protein A (1B), with appropriate mass load calculations (2B) and dilution (3B) prior to the prep Protein A step (4).
- An optional carboxypeptidase B (CpB) digest for terminal Lysine removal (5) prior to IEC separation.
- Pre-fractionation tool for further PTM profiling by interlaced SEC (6) or HIC (7).
- Purified IgG sample digestion for peptide mapping for more detailed characterization and Mass Spectrometry (8).
- Purified IgG samples are treatment with PNGase F (or other glycosidase) for glycan profiling (9).

A combination of these separation techniques allows users to achieve a wide range of analytical tasks, such as:

- Purity and titer check
- Aggregation analysis
- Charge variant analysis
- Fermentation monitoring
- Clips and truncations
- Light chain/heavy chain analysis
- Peptide mapping
- Glycan profiling
- Post-translational modification analysis (Amino acid substitutions/truncations, deamidation, phosphorylation, etc.)

Each of these tasks requires careful selection of the chromatographic method to achieve optimum results. We can support scientists in the biopharmaceutical industry in achieving these goals with a range of total solutions capable of creating excellent reliable results.

Affinity Titer Determination of mAbs



Early in the development of recombinant mAbs, a large number of harvest cell culture (HCC) samples must be screened for IgG titer. The high degree of specificity offered by affinity chromatography employing Protein A provides a powerful alternative to immunoaffinity methods such as ELISA.

Protein A is often used due to its strong affinity to bind a wide range of antibodies. By linking Protein A to a chromatographic media, an affinity column can be created to determine the mAb concentration in HCC.

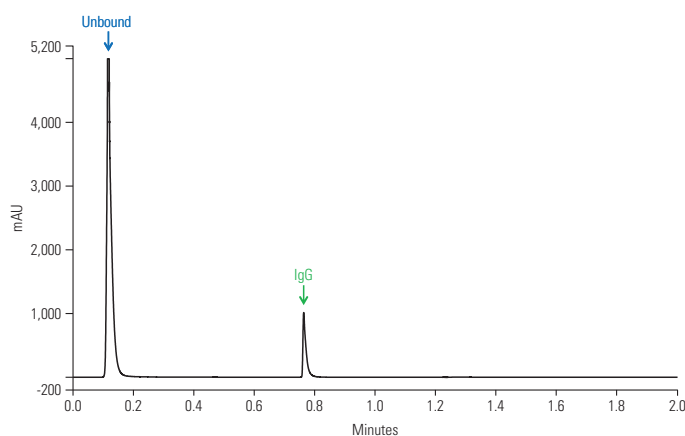

Column:	MABPac Protein A , 12 μ m 4.0 \times 35 mm
Mobile Phase A:	50 mM sodium phosphate, 150 mM sodium chloride, 5% acetonitrile, pH 7.5
Mobile Phase B:	50 mM sodium phosphate, 150 mM sodium chloride, 5% acetonitrile, pH 2.5
Gradient:	0% B for 0.2 mins, 100% B for 0.60 mins, 0% B for 1.20 mins
Flow Rate:	2 mL/min
Inj. Volume:	10 μ L
Temp:	25 $^{\circ}$ C
Detection:	280 nm
Sample:	Harvest cell culture (HCC)

The challenge facing the analytical laboratories in the pharmaceutical industry is to develop a high-throughput and robust titer assay. The recently developed novel column specifically for this application, Thermo Scientific™ MABPac™ Protein A has been engineered from a novel polymeric resin with a hydrophilic surface, covered with a covalently bound recombinant Protein A.

The hydrophilic nature of the backbone minimizes non-specific binding, and therefore enables accurate quantification of the mAb titer. The MABPac Protein A column format allows rapid automation of loading, binding, elution and collection using biocompatible systems from Thermo Fisher Scientific.

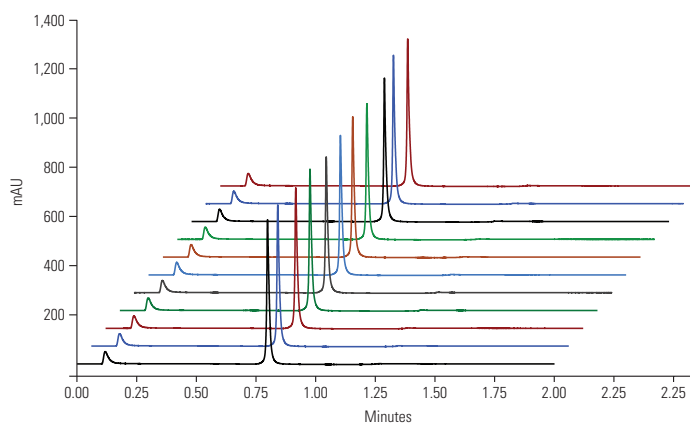

Column:	MABPac Protein A , 12 μ m 4.0 \times 35 mm
Mobile Phase A:	50 mM sodium phosphate, 150 mM sodium chloride, 5% acetonitrile, pH 7.5
Mobile Phase B:	50 mM sodium phosphate, 150 mM sodium chloride, 5% acetonitrile, pH 2.5
Gradient:	0% B for 0.2 mins, 100% B for 0.60 mins, 0% B for 1.20 mins
Flow Rate:	2 mL/min
Inj. Volume:	20 μ L
Temp:	25 $^{\circ}$ C
Detection:	280 nm
Sample:	Rabbit IgG, 1 mg/mL

	t_r (min)	Area (mAu*min)	PWVH (min)
Average	0.80	7.76	0.01
% RSD	1.02	2.20	0.00

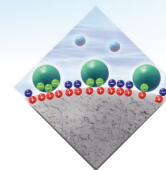

Charge Variant Analysis Using Ion Exchange Chromatography

Ion Exchange Chromatography (IEC) utilises a stationary phase with a charged ligand on the surface interacting with analytes of the opposite charge. The technique is divided between anion exchange and cation exchange chromatography. In anion exchange a positively charged surface ligands interacts with negatively charged analytes, whilst in cation exchange negatively charged surface ligands interact with positively charged analytes. In IEC, elution of the mAb charge variants can be performed by employing either a salt gradient or a pH gradient

In salt-gradient-based IEC, the pH of the buffer is fixed. In addition to choosing the appropriate pH of the starting buffer, its ionic strength is kept low since the affinity of proteins for IEC resins decreases as ionic strength increases. The proteins are then eluted by increasing the ionic strength (salt concentration) of the buffer to increase the competition between the buffer ions and proteins for charged groups on the IEC resin. As a result, the interaction between the IEC resin and proteins is reduced, causing the proteins to elute.

In pH-gradient-based IEC, the pH of the starting buffer is maintained at a constant level to ensure the proteins obtain the opposite charge of the stationary phase and bind to it. The proteins are eluted by changing the buffer pH so the proteins transition to a net zero charge (and ultimately the same charge as the resin) and elute from the column.

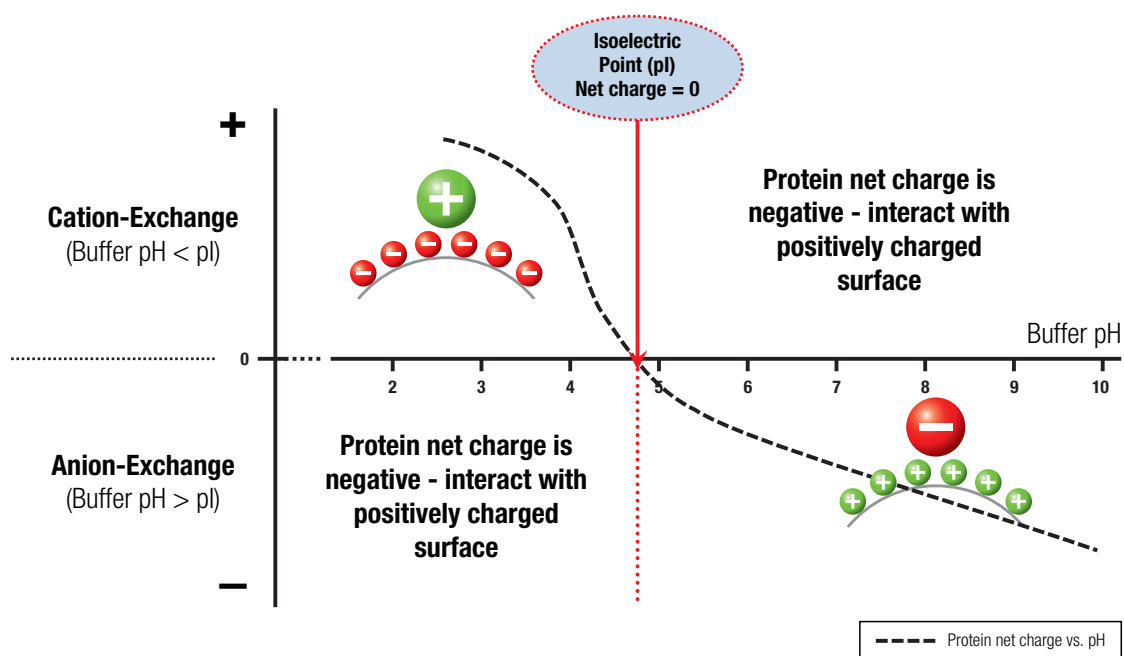

The mAbs undergo several post-translational modifications including oxidations, deamidations, glycosylation, incomplete C-terminal processing, and others. These modifications cause antibody variants in the cloning process, which in turn can impact the mAb activity and stability as a biotherapeutic agent. Monitoring stability of therapeutic mAb is essential for demonstrating safety and efficacy of the antibody as a drug.

The pI of the majority of antibodies tends to be in the pH 6–10 region, which is the reason why cation exchange is usually the chosen separation mode for mAb charged variants.

Now available is a range of cation exchange MAbPac columns designed specifically for the separation of mAb variants and other variations affected by charge.

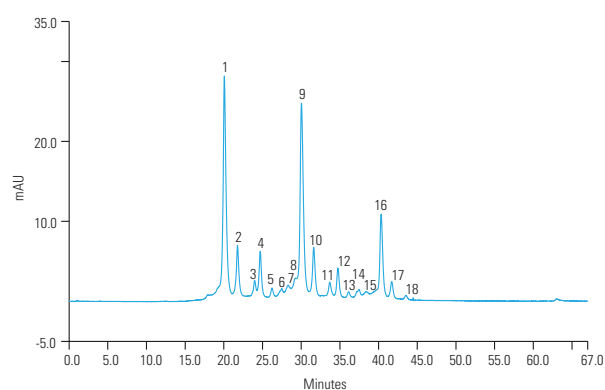

Column:	MAbPac SCX-10 , 10 μ m 4.0 \times 250 mm
Mobile Phase A:	20 mM MES (pH 5.6) + 60 mM sodium chloride
Mobile Phase B:	20 mM MES (pH 5.6) + 300 mM sodium chloride
Gradient:	5–55% B in 60 min
Flow Rate:	1 mL/min
Inj. Volume:	10 μ L
Temp:	30 $^{\circ}$ C
Detection:	280 nm

One of the most important and common analyses of monoclonal antibody heterogeneity is the monitoring and determination of acidic and basic variants. Thermo Scientific™ MAbPac™ SCX-10 column separates lysine truncation variants before and after incubation with carboxypeptidase B.

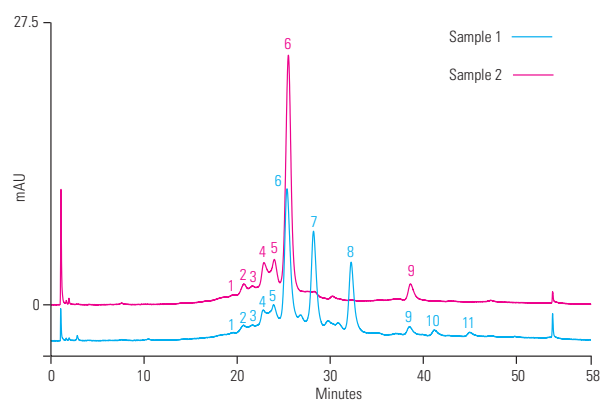

Column:	MAbPac SCX-10 , 10 μ m 4.0 \times 250 mm
Mobile Phase A:	20 mM MES (pH 5.6) + 60 mM sodium chloride
Mobile Phase B:	20 mM MES (pH 5.6) + 300 mM sodium chloride
Gradient:	15–36% B in 50 min
Flow Rate:	1 mL/min
Inj. Volume:	5 μ L
Temp:	30 $^{\circ}$ C
Detection:	280 nm
Samples:	1. mAb B, 900 μ g in 100 μ L (no carboxypeptidase) 2. mAb B, 900 μ g in 100 μ L + carboxypeptidase, 50 μ g, incubation at 37 $^{\circ}$ C for 3 h

Both Chromatograms:	Peaks 1–5: Acidic variants
Sample 1:	Peaks 6–8: C-Terminal lysine truncation variants of main peak Peaks 9–11: C-Terminal lysine truncation variants of minor variant peak
Sample 2:	Peak 6 results from peaks 6, 7, and 8 after CBP treatment Peak 9 results from peaks 9, 10, and 11 after CBP treatment

Platform Method Using Ion Exchange pH Gradient

In the fast-paced drug development environment, a platform method to accommodate the majority of mAb analyses is desired. Considerable effort is often required to tailor the salt gradient method for a cation exchange separation of an individual mAb. Ion exchange separations by pH gradient provide the advantage of a generic platform approach, thus removing the need for individual sample method development.

This approach features a multi-component zwitterionic buffer system in which the linear gradient can be run from 100% eluent A (low pH buffer) to 100% eluent B (high pH buffer). Once the approximate pH elution range of the target mAb has been established in the initial run, further optimization of separation can simply be achieved by running a shallower pH gradient in a narrower pH range. The optimization of a mAb variant separation is achieved by addressing the pH gradient range. When a broad pH gradient is applied from 0% to 100% B (pH 5.6 to 10.2 a, top), all analytes are eluted in the pH range 7.0 to 8.0. By progressively adjusting the gradient to 0–50% B (5.6–7.9 pH range, b middle) and 25–50% B (6.75–7.9 pH range, c bottom), resolution is further improved with minimal optimization steps.

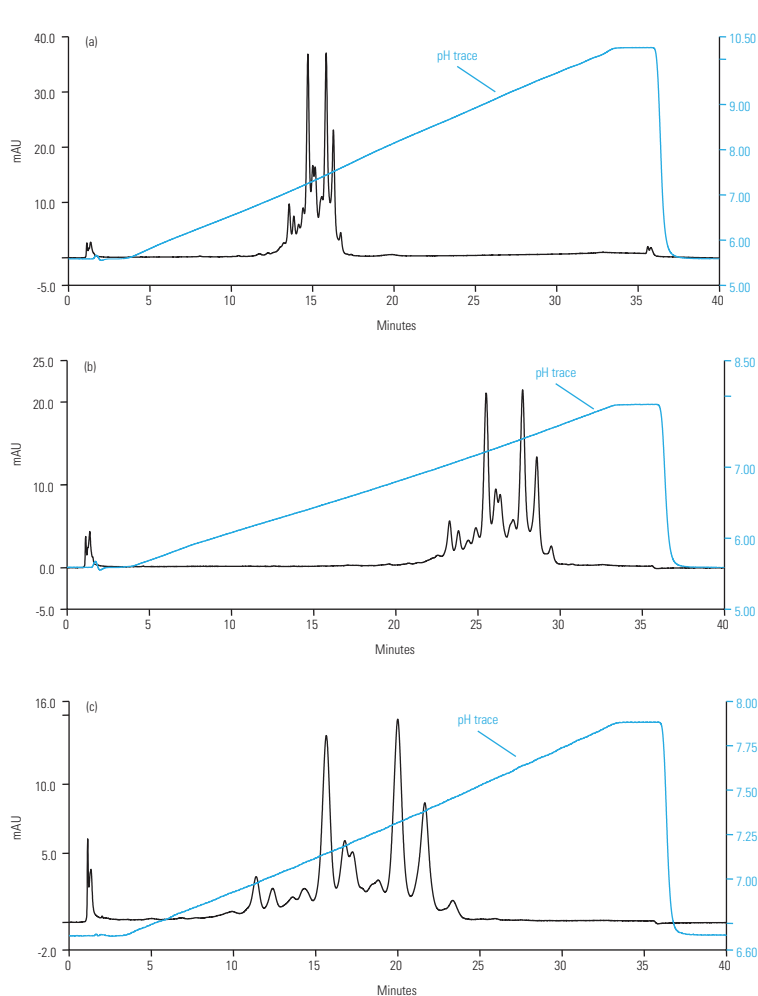

Column:	MABPac SCX-10 , 10 μ m 4.0 \times 250 mm
Eluent A:	pH gradient buffer A
Eluent B:	pH gradient buffer B
pH gradient:	(a) 0% B (pH 5.6) to 100% B (pH 10.2) (b) 0% B (pH 5.6) to 50% B (pH 7.9) (c) 25% B (pH 6.75) to 50% B (pH 7.9)

Using a pH gradient to predict charge variant pI

Monitoring the eluent pH during a pH gradient makes charge variant characterization simpler and more predictable because proteins and mAbs will only elute once the eluent pH is above the biomolecules pI. The measured pH values for six proteins exhibit a strong linear correlation to the literature based pI values. This shows that the pI of a protein component can be estimated based on the peak retention time and measured pH.

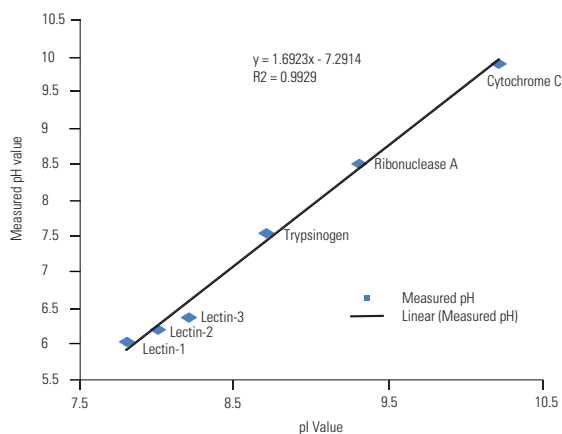

Platform Method Using Ion Exchange pH Gradient–pH designer buffer capabilities

Tailoring pH gradients for individual needs is easily achieved using the Thermo Scientific™ pH Designer Software. The package describes how to create unique buffer formulations from a multitude of components and even predicts ionic strength, buffering capacity as well as pH profiles through a separation gradient.

The linearity of the pH gradient can be further verified using the Thermo Scientific™ Dionex™ UltiMate™ 3000 pH and conductivity online monitor, which can be added to UltiMate 3000 BioRS system to serve as a platform for pH gradient ion exchange chromatography.

The UltiMate 3000 pH and conductivity monitor is a valuable tool for HPLC method development, particularly for protein and nucleic acid separations. It enables linking the mobile phase pH and/or conductivity with the elution time of the components. The pH and conductivity monitor allows for the monitoring of gradient formation, column equilibration, and understanding column buffering effects in pH gradient ion-exchange chromatography.

Size Exclusion Chromatography for Aggregate Screening

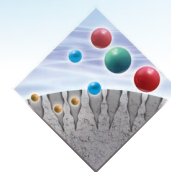

The biopharmaceutical industry has continued its focus on the development of biotherapeutic mAb drugs. The mAbs produced from mammalian cell culture may contain significant amounts of dimers and higher-order aggregates. Studies show that these aggregates present in drug products may result in enhanced desired response, but may also cause severe immunogenic and anaphylactic reactions. Thus, biopharmaceutical manufacturers are required to develop analytical methods to monitor size heterogeneity and control levels of dimer and higher-order aggregates.

Size-exclusion chromatography (SEC) is an ideal choice of separation for mAb aggregates. In SEC the separation is based solely on the size of the molecule, with no interaction with the media surface. Molecules of different sizes penetrate the pores to varying extents. This results in analytes of different sizes travelling through the media at different retention times. Larger molecules do not diffuse deep in the pores and elute first, whilst smaller entities diffuse deeper in the pores and elute later.

The Thermo Scientific™ MAbPac™ SEC-1 column is specially designed for the separation and characterization of mAbs, their aggregates, and analysis of Fab and Fc fragments. The MAbPac SEC-1 column is based on high-purity, spherical, porous (300 Å), 5 µm silica particles that are covalently modified with a hydrophilic layer, resulting in an extremely low level of non-desired interaction sites. The stationary phase is designed to handle different eluent conditions containing both high and low ionic strength mobile phases, as well as mass spectrometry friendly volatile eluents.

The MAbPac SEC-1 column has excellent separation power for the analysis of antibody aggregates. Higher order aggregates are clearly baseline resolved from the monomer. For increased sample throughput, an even further reduced runtime can be achieved using the 150 mm long version of the MAbPac SEC-1 column. A highly recognizable elution profile is visible, in under 4 min of sample analysis time.

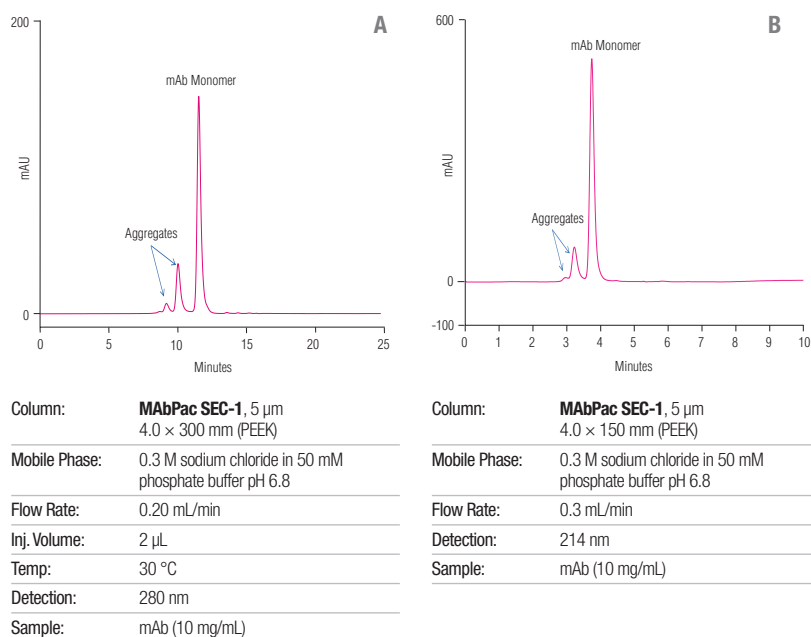

Hydrophobic Interaction Chromatography in mAb Analysis

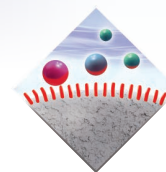

Oxidation of methionine residues and deamidation of asparagine residues are the major causes of chemical degradation of biological pharmaceuticals. It is therefore important to fully characterize these variants.

Hydrophobic Interaction Chromatography (HIC) is an important tool for protein chemists separating proteins under gentle conditions that do not cause denaturation. Biomolecules are separated by their degree of hydrophobicity. The mobile phase consists of a salting-out agent, which at high concentration retains the protein by increasing the hydrophobic interaction between the solute and the stationary phase.

The bound proteins are eluted by decreasing the salt concentration. Since proteins are relatively stable in the salt solutions used as the mobile phase, the biological activity of proteins is usually maintained in HIC. This makes HIC separations ideal for high resolution analyses as well as a purification step or polishing prior to analysis.

The Thermo Scientific™ ProPac™ HIC-10 is a silica based support developed specifically to deliver extended robustness in the highly aqueous, buffered conditions required for HIC separations. The advanced hydrolytic stability enables the user to achieve highly efficient separations typical of silica columns, whilst providing backpressure robustness typically lacking from polymeric HIC media. The excellent loading capacity of the ProPac HIC-10 provides an excellent tool for purification of mAb samples.

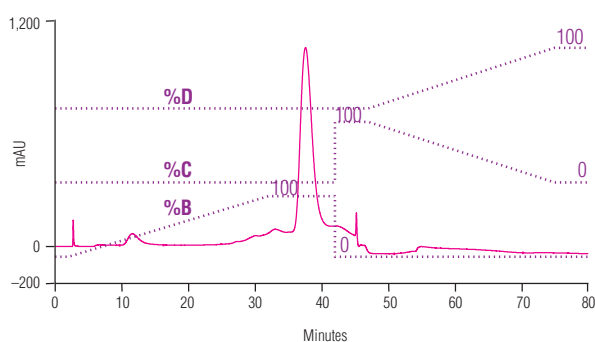

Column:	ProPac HIC-10 , 5 µm 7.8 × 75 mm
Mobile Phase A:	1 M ammonium sulphate in 0.1 M mono sodium phosphate (pH 7.0)
Mobile Phase B:	0.1 M mono sodium phosphate (pH 7.0)
Mobile Phase C:	D.I. water
Mobile Phase D:	35% acetonitrile
Dual Gradient:	0–100% B in 30 min after equilibration: 0–100% D in 28 min
Flow Rate:	1 mL/min
Inj. Volume:	20 µL (166 µg)
Detection:	214 nm
Sample:	mAb 100 µL (50 mg/mL) + 300 µL 2 M ammonium sulphate in 0.1 M mono sodium phosphate (pH 7.0) + 200 µL PBS

The high resolution capacity of the ProPac HIC-10 columns is an invaluable tool in the separation of oxidation variants, used for assessment of mAb stability. The forced methionine oxidation variant separation from a main mAb drug product on a PropPac HIC-10 column. Additionally the separation by HIC is orthogonal to the separation by ion exchange and so adds increased selectivity to mAb characterization.

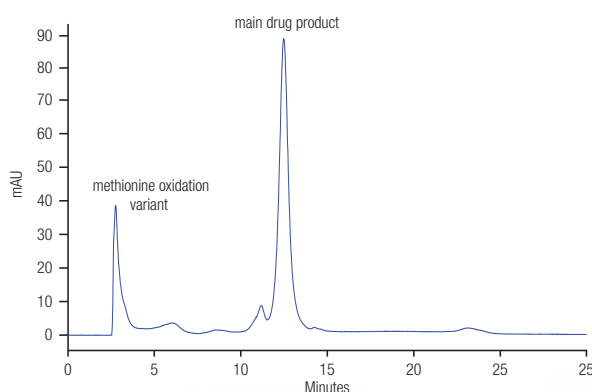

Column:	ProPac HIC-10 , 5 µm 4.6 × 100 mm
Mobile Phase A:	1M ammonium sulphate in 0.1 M mono sodium phosphate, pH 7.0
Mobile Phase B:	0.1 M mono sodium phosphate, pH 7.0
Flow Rate:	0.75 mL/min
Inj. Volume:	100 µL (50 µg)
Detection:	220 nm
Sample:	mAb

Analysis of Intact and Reduced Antibodies

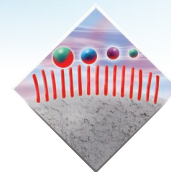

In order to verify the correctness of the overall molecule to provide a reproducible, safe and effective biological drug compound, the correct protein sequence as well as the presence and relative abundance of different glycoforms have to be confirmed. The simplest way to achieve this is to interface the separation with high resolution MS detection. Typically, mAbs are analyzed in either their intact form, in reduced light/heavy chain form or after enzymatic cleavage into Fab and Fc domains.

Reversed-phase chromatography has been used for many years as an excellent interface with MS detection. The low concentrations of volatile buffers combined with the high organic make-up of the mobile phase result in conditions ideal for stable and effective spray. Furthermore, the separation principle offers an alternative selectivity based on hydrophobicity, which provides orthogonal high-resolution separations that may be more sensitive to small hydrophobic mutations.

Intact Protein Analysis

The Thermo Scientific™ ProSwift™ RP-4H Monolith HPLC column can be used for intact protein analysis e.g. the analysis of a Campath Monoclonal Antibody (alemtuzumab), which is used to treat chronic lymphocytic leukaemia. Monolithic materials offer, amongst their advantages, low carry over and high resolution of large molecules. This feature is an ideal benefit in antibody analysis, due to the large size of the protein (typical MW of 150 kDa).

This analysis can be coupled to high-resolution mass spectrometry systems to confirm the accurate molecular weight of the target product and identify variants.

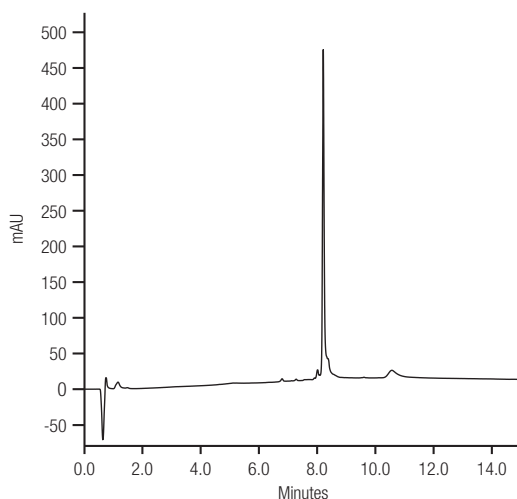

Column:	ProSwift RP 4H 1.0 × 250 mm
Eluent A:	2.5% Acetonitrile, 0.1% TFA
Eluent B:	90% Acetonitrile, 0.1% TFA
Gradient:	10% to 70% B in 15 min for both Accucore C4 and ProSwift RP-4H
Flow Rate:	300 µL/min
Temp:	70 °C

Protein Fragment Analysis

The interaction of an antibody with an antigen occurs at the fragment antigen binding (Fab) region, which is flexibly linked to the fragment crystallizable (Fc) region. Fragmented antibody analysis in reversed-phase LC-MS/MS workflows allows for higher level structural identification of the two regions. The excellent performance of the Thermo Scientific™ Accucore™ 150-C4 HPLC columns for mAb fragment analysis is shown in the analysis of Campath Fab fragment. The superior performance of the C4 superficially porous material allows the separation of several minor variant peaks, shown in the expanded area of the chromatogram.

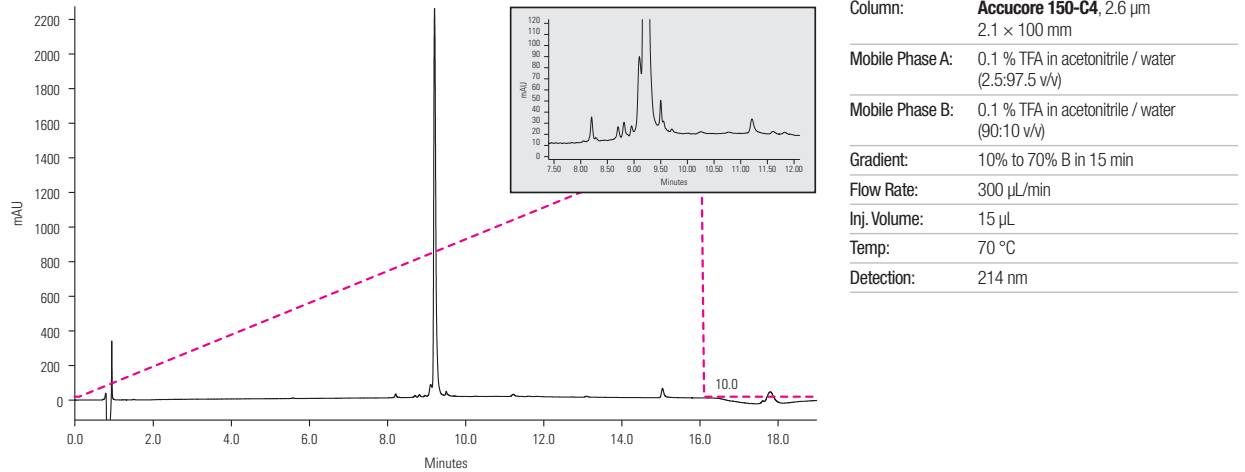

Further structural elucidation is obtained by reducing the Fab fragment into its light and heavy chain components. Interface with high resolution MS allows the identification of different glycoforms in the heavy chain.

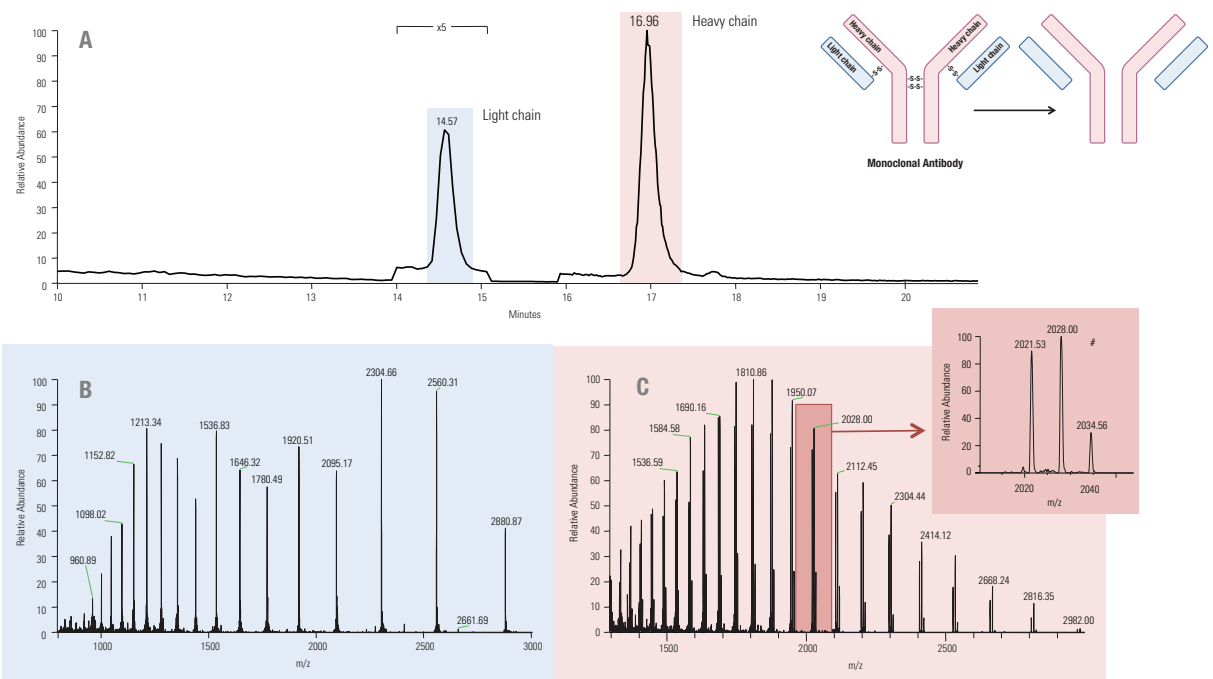

Glycan Profiling for mAb Variant Characterization

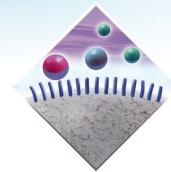

Glycans are oligosaccharides and polysaccharides widely distributed in biological systems in 'free state' and conjugated forms such as glycoproteins, glycolipids, and proteoglycans. They are involved in a wide range of biological and physiological processes and are often key biomarkers for disease states such as cancer. Their functions, including efficacy and safety of protein-based drugs such as recombinant proteins and mAbs, are often dependent on the structure and types of glycans attached to the proteins. The structures of glycans are quite diverse, complex, and heterogeneous. Glycosylation of antibodies is a prime source of product heterogeneity with respect to both structure and function. Variation in glycosylation is one of the main factors in product batch-to-batch variation, affecting product stability and Fc effector functions in vivo. As a result, the structural characterization and quantitative estimation of glycans is highly essential in biotherapeutics and biopharmaceutical projects.

HILIC columns commonly used for glycan analysis are based on amide, amine, or zwitterionic packing materials. These columns separate glycans mainly by hydrogen bonding, resulting in separations based on size and composition. The recently developed Thermo Scientific™ GlycanPac™ AXH-1 and AXR-1 columns, a high-performance HPLC/UHPLC range of columns specifically designed for structural, qualitative, and quantitative analysis of glycans. The stationary phase of GlycanPac AXH-1 and AXR-1 columns are based on advanced mixed-mode chromatography technology, allowing to overcome conventional limitations associated with glycan separations. The novel stationary phase allows the separation of glycans based on charge, size, and polarity configuration.

The GlycanPac AXR-1 column surface chemistry combines both weak anion-exchange (WAX) and reversed-phase interaction mechanisms to produce exceptional glycan selectivity and industry-leading resolution. The WAX functionality provides retention of negatively charged glycans that elute in order of increasing charge, and the reversed-phase interactions facilitate high-resolution separation of glycans of the same charge according to their isomeric structure and size. The GlycanPac AXH-1 column, combines both WAX and Hydrophilic Interaction Liquid Chromatography (HILIC) retention mechanisms for improved resolution of neutral and acidic glycans. The WAX functionality provides retention and selectivity for negatively charged glycans, while the HILIC mode facilitates the separation of glycans of the same charge according to their polarity and size. Both columns are designed and tested for HPLC and UHPLC methods using either fluorescence or MS detection applications, and use volatile aqueous buffers (e.g., ammonium acetate or ammonium formate) and acetonitrile, presenting the eluting glycans ready for introduction into MS instruments.

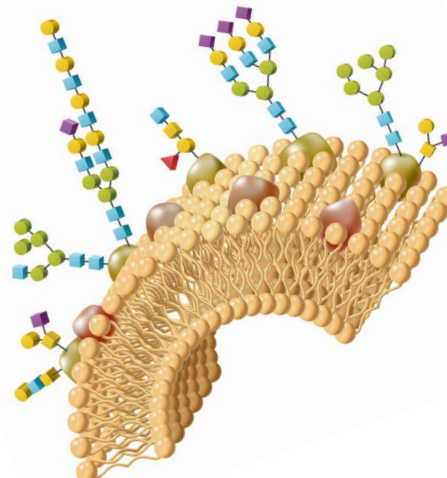

A representative example of the chromatographic separation of antibody glycans is shown below, where 2AA labeled *N*-glycans from human IgG were separated using the GlycanPac AXH-1 column with 1.9 μ m particle. Characterization of glycans in each peak was performed by interfacing the separation with a Thermo Scientific™ Q Exactive™ Mass Spectrometer in data-dependent acquisition. Separation of glycans based on charge provides advantages compared to other commercially available HILIC columns. Characterization was achieved using SimGlycan® software, allowing identification of all observed species.

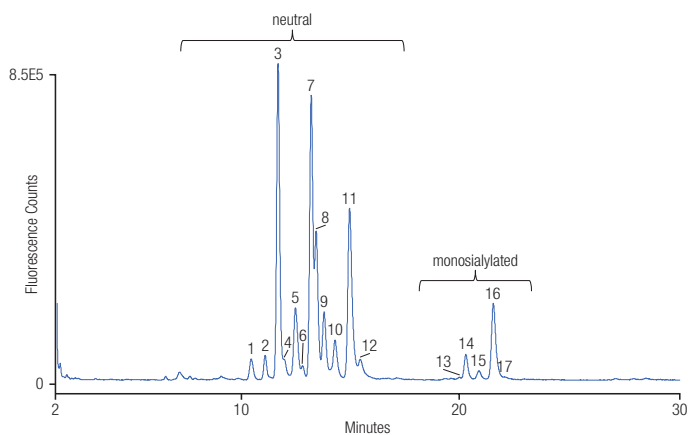

Column:	GlycanPac AXH-1 , 1.9 μ m 2.1 \times 150 mm
Mobile Phase A:	Acetonitrile (80%) + water (20%)
Mobile Phase B:	Ammonium formate (80 mM, pH = 4.4)
Flow Rate:	0.4 mL/min
Inj. Volume:	20 Pmoles
Temp:	30 °C
Detection:	320/420 nm
Sample:	2AA labeled <i>N</i> -glycan from human IgG

Time (min)	% A	% B	Flow (mL/min)	Curve
-10	99	1.0	0.4	5
0	99	1.0	0.4	5
30	87.5	12.5	0.4	5

MS Characterization by SimGlycan® Software of human IgG *N*-Glycans

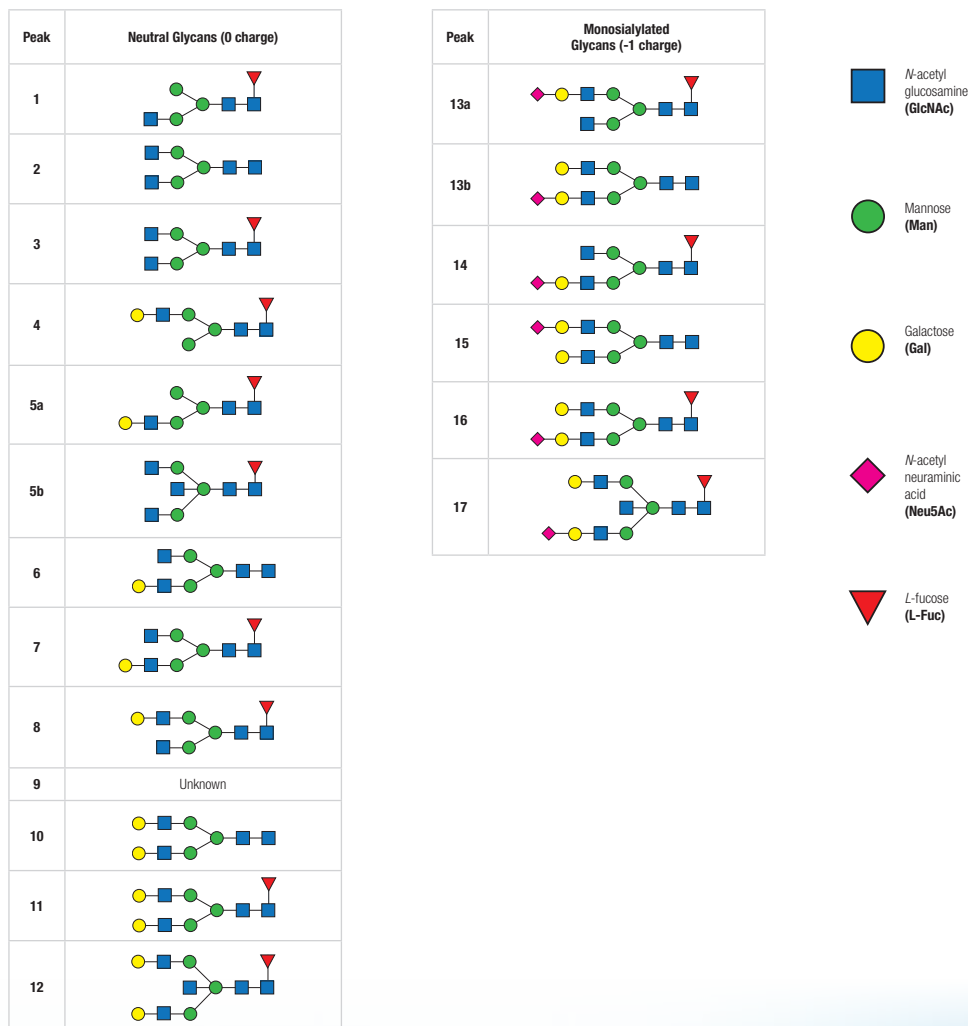

Bringing Biomolecule Characterization Towards UHPLC

The UltiMate 3000 BioRS system is specifically designed for characterization of biomolecules, such as proteins, peptides and other biotherapeutics. Equipped with the new biocompatible Thermo Scientific™ Dionex™ Viper™ Fingertight Fitting Technology, the system provides metal-free flow paths throughout with virtually zero-dead volume for maximum performance.

Highest resolution and sensitivity for biomolecule characterization are readily available for every laboratory by incorporating the state-of-the-art UHPLC system with our innovative column technology.

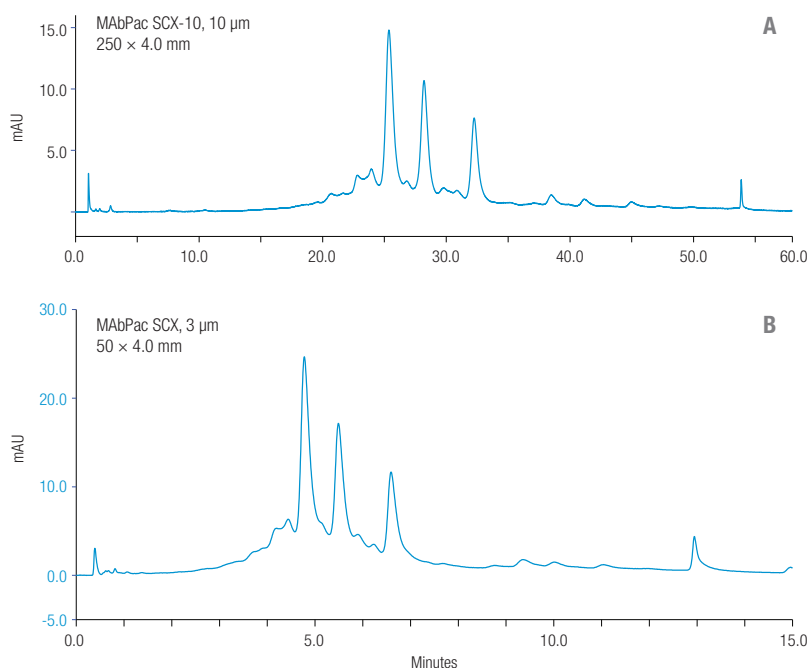

Column A:	MAbPac SCX-10 , 10 µm 4.0 × 250 mm
Column B:	MAbPac SCX-10 , 3 µm 4.0 × 50 mm
Mobile Phase A:	20 mM MES + 60 mM sodium chloride, pH 5.6
Mobile Phase B:	20 mM MES + 300 mM sodium chloride, pH 5.6
Gradient A:	15–36.44% B in 50 min
Gradient B:	20–35% B in 10 min
Flow Rate: A	1.0 mL/min
Flow Rate: B	B: 0.6 mL/min
Temp:	30 °C
Detection:	280 nm
Sample:	For A: 10 mg/mL; 5 µL (50 µg injection) For B: 1 mg/mL; 15 µL (15 µg injection)

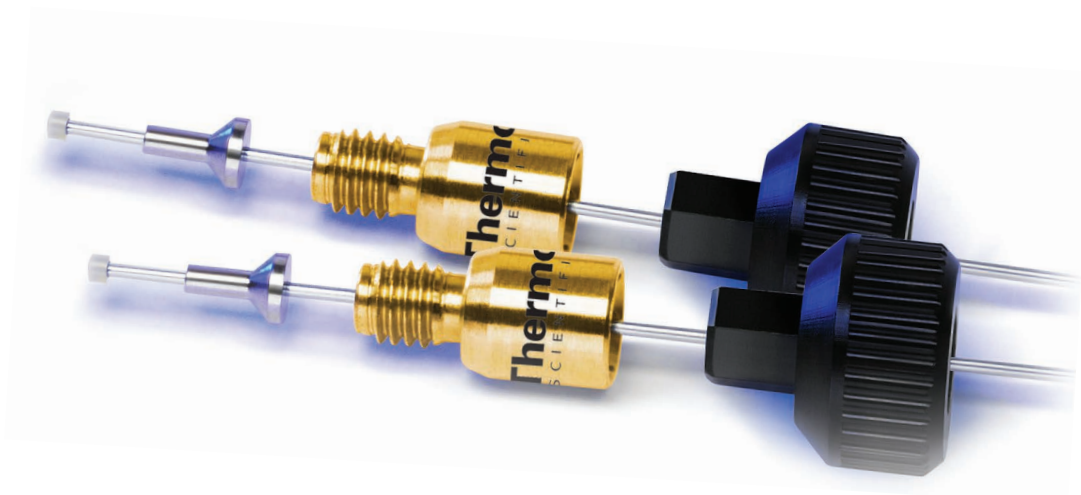

Taking advantage of the integrated fractionation capabilities, purification and analysis can be performed in a fully automated multi-column setup, even when analyzing hundreds of mAb samples.

Cell culture fluid samples containing antibodies are injected onto a Protein A column for antibody recovery, then the extracted antibody samples are automatically injected, first onto the SEC column, and then onto the IEC column. The workflow is fully automated on the UltiMate 3000 system.

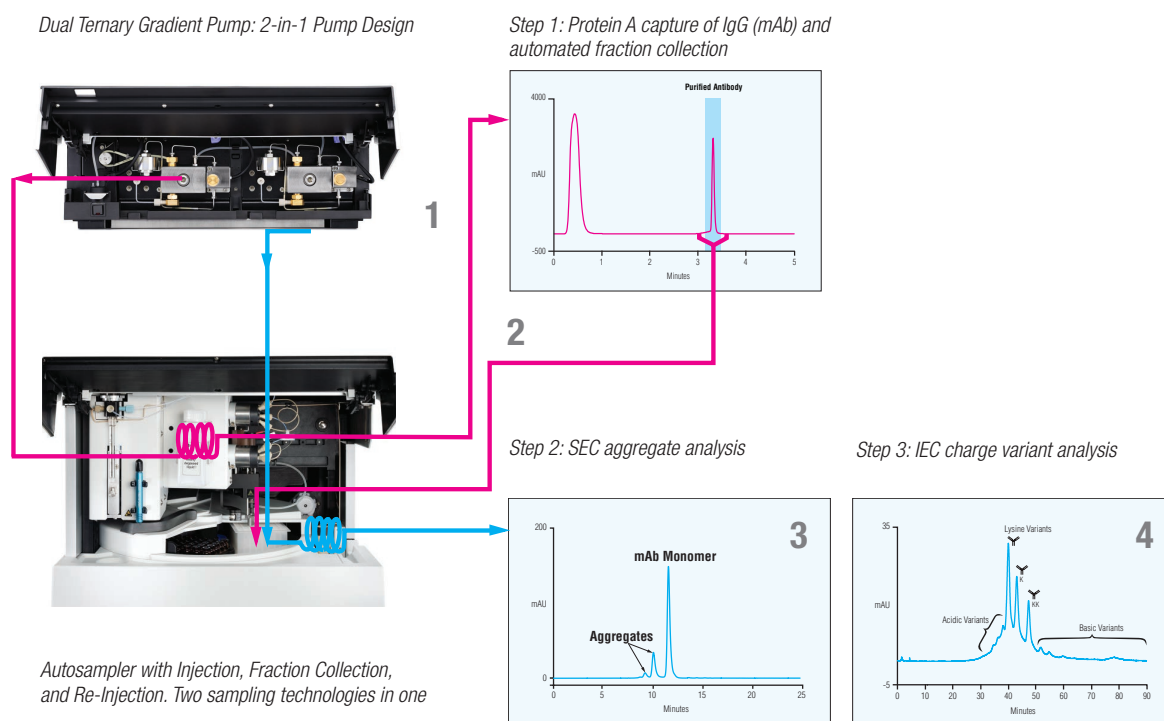

Biocompatible UltiMate 3000 automated mAb analysis.

Samples are first Protein A affinity purified (1) and fraction collected (2). The fractions are re-injected for SEC aggregate separation (3), followed by charge variant analysis by IEC (4).



LC-MS Workflows for mAb Separation and Characterization

Mass spectrometry (MS), especially high-resolution and accurate-mass (HRAM) MS, has become widely used in virtually all phases of protein drug development. Modern HRAM technologies provide accurate information on various protein properties, such as intact molecular mass, glycosylation forms, amino acid sequence, post-translational modifications, and minor impurities due to sample processing and storage, as well as higher-order structural information, such as protein conformational changes upon modifications, noncovalent interactions between protein drugs and receptor proteins, and protein aggregation caused by misfolding. Mass analysis at the intact protein level is usually the first step of the structural characterization.

Orbitrap Technology: A Perfect Fit with Biomolecule Characterization

To obtain accurate and reproducible measurements on intact mAb, it is crucial that the instrument has high sensitivity, high resolution, high mass accuracy, and high acquisition speed. Both quadrupole-Orbitrap instruments and hybrid linear ion trap-Orbitrap instruments are well suited for intact mass measurement and for top-down sequencing. Improved electronics in the Thermo Scientific™ Orbitrap™ range of mass spectrometers, allow for significantly improved sensitivity for antibody analysis.

Advanced signal processing provides the high resolving power up to 140,000 at m/z 200 for the Exactive Plus, Exactive Plus EMR and Q Exactive, up to 280,000 at m/z 200 for the Q Exactive Plus, up to 240,000 at m/z 400 for the Orbitrap Elite and up to 450,000 at m/z 200 for the Orbitrap Fusion and high mass accuracy for accurate measurement without compromising acquisition rate.

The incorporation of S-lens and AGC-based acquisition ensures high sensitivity in MS and MS/MS mode. High quality spectra are routinely obtained for intact mass measurement and for top-down sequencing of mAb.



Complete workflow for the extraction, separation and characterization of mAb therapeutics

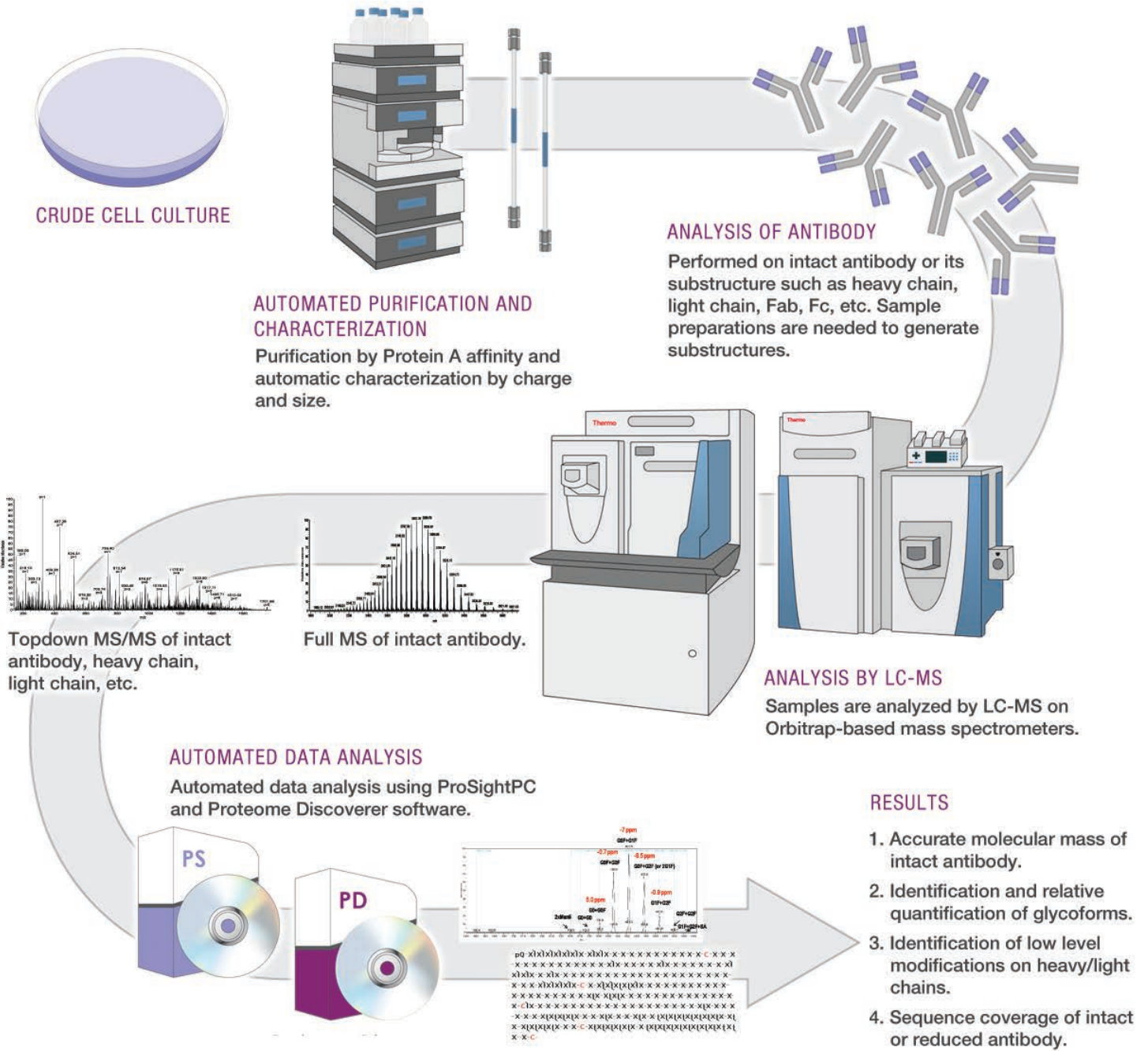

Ordering Information

Application: Affinity Titer Determination

MABPAC Protein A

Particle Size (µm)	Format	Length (mm)	4.0 mm ID
12	HPLC Column	35	082539

Application: IEC Charge Variant Analysis

ProPac WCX-10

Particle Size (µm)	Format	Length (mm)	2.1 mm ID	4.0 mm ID	9.0 mm ID	22.0 mm ID
10	Guard Column	50	063480	054994	–	–
	HPLC Column	50	–	074600	–	–
		100	–	SP5829	–	–
		150	–	SP7603	–	–
		250	063472	054993	063474	SP5482

MABPac SCX-10

Particle Size (µm)	Format	Length (mm)	2.1 mm ID	4.0 mm ID	9.0 mm ID
3	HPLC Column	50	–	077907	–
5	HPLC Column	50	–	078656	–
		150	–	085198	–
		250	–	078655	–
		10	Guard Column	50	075749
10	HPLC Column	50	–	075603	–
		150	–	075602	–
		250	075604	074625	SP6866

MABPac SCX-10 RS

Particle Size (µm)	Format	Length (mm)	2.1 mm ID	4.6 mm ID
5	BioRS Column	50	082675	082674
		150	088242	085209
		250	082515	082673

pH Buffer Concentrates

Description	Part Number
CX-1 pH Gradient Buffer A (pH 5.6), 125 mL	083273
CX-1 pH Gradient Buffer B (pH 10.2), 125 mL	083275
CX-1 pH Gradient Buffer Kit (pH 5.6 to 10.2), 125 mL	083274
CX-1 pH Gradient Buffer A (pH 5.6), 250 mL	085346
CX-1 pH Gradient Buffer B (pH 10.2), 250 mL	085348
CX-1 pH Gradient Buffer Kit (pH 5.6 to 10.2), 250 mL	085349
pH Designer Software	085022

Ordering Information

Application: Aggregate Separation

MABPac SEC-1

Particle Size (µm)	Format	Length (mm)	4.0 mm ID
5	Guard Column	50	074697
	HPLC Column	150	075592
		300	074696

Application: Met/Trp Oxidation and Asp Variant Analysis

ProPac HIC-10

Particle Size (µm)	Format	Length (mm)	2.1 mm ID	4.6 mm ID	7.8 mm ID
5	HPLC Column	75	–	–	063665
		100	063653	063655	–
		250	–	074197	–

Application: RP Intact and Fragmented mAb Analysis

ProSwift RP

Functional Group	Length (mm)	1.0 mm ID	4.6 mm ID
RP-2H	50	–	064296
RP-4H	50	069477	–
RP-4H	250	066640	–

Accucore Columns for Biomolecules

Particle Size (µm)	Format	Length (mm)	ID (mm)	150-C18	150-C4		
2.6	Defender Guard (4/pk)	10	2.1	16126-012105	16526-012105		
			3.0	16126-013005	16526-013005		
			4.6	16126-014005	16526-014005		
	HPLC Column	30	30	2.1	16126-032130	16526-032130	
				3.0	16126-033030	16526-033030	
				4.6	16126-034630	16526-034630	
		50	50	50	2.1	16126-052130	16526-052130
					3.0	16126-053030	16526-053030
					4.6	16126-054630	16526-054630
		100	100	100	2.1	16126-102130	16526-102130
					3.0	16126-103030	16526-103030
					4.6	16126-104630	16526-104630
	150	150	150	2.1	16126-152130	16526-152130	
				3.0	16126-153030	16526-153030	
				4.6	16126-154630	16526-154630	
	250		250	2.1	–	–	

Ordering Information

Application: mAb Glycan Profiling

GlycanPac AXH-1

Particle Size (µm)	Format	Length (mm)	2.1 mm ID	3.0 mm ID	4.6 mm ID
1.9	UHPLC Column	100	082473	–	–
		150	082472	–	–
		250	082521	–	–
3	Guard Cartridges (2/pk)	10	082476	082475	082474
	HPLC Column	150	082470	082469	082468

GlycanPac AXR-1

Particle Size (µm)	Format	Length (mm)	2.1 mm ID	3.0 mm ID	4.6 mm ID
1.9	UHPLC Column	100	088136	–	–
		250	088135	–	–
3	Guard Cartridges (2/pk)	10	088258	088259	088260
	HPLC Column	150	088251	088252	088255

Resources

for Chromatographers

Thermo Scientific Chromatography Columns and Consumables Catalog

This extensive catalog includes over 650 pages of proven chromatography tools and product selection guides. Available online, with a robust search tool and optimized for your iPad®.

Visit www.thermoscientific.com/catalog

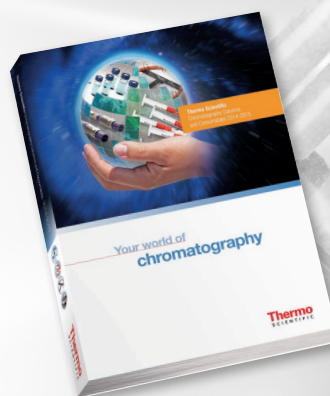

Chromatography Resource Center

Our web-based resource center provides technical support, applications, technical tips and literature to help move your separations forward.

Visit www.thermoscientific.com/crc



For more information visit: www.thermoscientific.com/biolc

© 2014 Thermo Fisher Scientific Inc. All rights reserved. SimGlycan® is a registered trademark of PREMIER Biosoft. iPad is a registered trademark of Apple Inc., registered in the US and other countries. All other trademarks are the property of Thermo Fisher Scientific and its subsidiaries. Specifications, terms and pricing are subject to change. Not all products are available in all countries. Please consult your local sales representative for details.

USA and Canada +1 800 332 3331
Australia 1300 735 292 (free call domestic)
China 800 810 5118 (free call domestic)
400 650 5118
France +33 (0)1 60 92 48 34
Germany +49 (0) 2423 9431 20 or 21

India +91 22 6742 9494
+91 27 1766 2352
Japan 0120 753 670 (free call domestic)
0120 753 671 fax
United Kingdom +44 (0) 1928 534 110
New Zealand 0800 933 966 (free call domestic)
Singapore +65 6289 1190
All Other Enquiries +44 (0) 1928 534 050

Technical Support
For advice and support,
please visit our website:
www.thermoscientific.com/chromexpert

Thermo
SCIENTIFIC

A Thermo Fisher Scientific Brand