



Thermo Scientific

Dionex CarboPac PA10

Column Product Manual

P/N: 065495-01 December 2012

Product Manual

for

Dionex CarboPac PA10 Guard Columns

(4 x 50 mm, P/N 046115)

(2 x 50 mm, P/N 057181)

Dionex CarboPac PA10 Analytical Columns

(4 x 250 mm, P/N 046110)

(2 x 250 mm, P/N 057180)

Dionex CarboPac PA10 Capillary Guard Column

(0.4 x 50 mm, P/N 082321)

Dionex CarboPac PA10 Capillary Column

(0.4 x 250 mm, P/N 082320)

© 2012 Thermo Fisher Scientific Inc. All rights reserved.

All trademarks are the property of Thermo Fisher Scientific Inc. and its subsidiaries.

Thermo Fisher Scientific Inc. provides this document to its customers with a product purchase to use in the product operation. This document is copyright protected and any reproduction of the whole or any part of this document is strictly prohibited, except with the written authorization of Thermo Fisher Scientific Inc.

The contents of this document are subject to change without notice. All technical information in this document is for reference purposes only. System configurations and specifications in this document supersede all previous information received by the purchaser.

Thermo Fisher Scientific Inc. makes no representations that this document is complete, accurate or error free and assumes no responsibility and will not be liable for any errors, omissions, damage or loss that might result from any use of this document, even if the information in the document is followed properly.

This document is not part of any sales contract between Thermo Fisher Scientific Inc. and a purchaser. This document shall in no way govern or modify any Terms and Conditions of Sale, which Terms and Conditions of Sale shall govern all conflicting information between the two documents.

Revision History:

Revision 01, December, 2012, Original Publication.

For Research Use Only. Not for use in diagnostic procedures.

Safety and Special Notices

Make sure you follow the precautionary statements presented in this guide. The safety and other special notices appear in boxes.

Safety and special notices include the following:



SAFETY

Indicates a potentially hazardous situation which, if not avoided, could result in death or serious injury.



WARNING

Indicates a potentially hazardous situation which, if not avoided, could result in damage to equipment.



CAUTION

Indicates a potentially hazardous situation which, if not avoided, may result in minor or moderate injury. Also used to identify a situation or practice that may seriously damage the instrument, but will not cause injury.



NOTE

Indicates information of general interest.

IMPORTANT

Highlights information necessary to prevent damage to software, loss of data, or invalid test results; or might contain information that is critical for optimal performance of the system.

Tip

Highlights helpful information that can make a task easier.

Contents

1. Introduction	8
2. System Requirements and Installation	9
2.1 System Requirements	9
2.1.1 System Requirements for 0.4 mm, 2 mm and 4 mm Operation	9
2.1.2 Installation of Disposable Electrode into an ED50 Cell, pH-Ag/AgCl Reference Electrode or PdH Reference Electrode.....	9
2.1.3 System Void Volume	9
2.2 The Injection Loop	9
2.2.1 The 4 mm System Injection Loop, 10 - 50 μ L	9
2.2.2 The 2 mm System Injection Loop, 2 - 15 μ L.....	9
2.2.3 The 0.4 mm System Injection Loop, 0.4 μ L Internal Loop.....	10
2.3 The Dionex CarboPac PA10 Guard Column.....	10
2.4 Installing the Dionex CR-ATC Trap Column for Use with Dionex EGC.....	10
2.5 Installation of the Capillary Column	10
2.6 Eluent Storage.....	14
3. Purity Requirements for Chemicals	15
3.1 Deionized Water	15
3.2 Sodium Hydroxide.....	15
3.3 Sodium Acetate.....	15
4. Before You Start	16
4.1 The Most Important Rules.....	16
4.2 Initial Check List	16
5. Preparation of Eluents and Standards	17
5.1 Eluent E1: Deionized Water	17
5.2 Eluent E2, E3: 0.018 M / 1 M Sodium Hydroxide	17
5.2.1 Sodium Hydroxide Eluent Concentration	18
5.3 Eluent E4: 100 mM Sodium Hydroxide/ 1 M Sodium Acetate	19
5.4 Sample Preparation.....	20
5.5 Verification of System Cleanliness	21
5.5.1 System Background Check	21
5.5.2 Verification of Column Cleanliness.....	22

6. Applications	23
6.1 Production Test Chromatograms Using Manually Prepared Eluent.....	23
6.2 Production Test Chromatograms Using Eluent Generator	26
6.3 Effect of Flow Rate on the Monosaccharide Analysis Using Dionex CarboPac PA10 (4 × 250 mm)	28
6.4 Effect of Flow Rate on the Monosaccharide Analysis Using Dionex CarboPac PA10 (0.4 × 250 mm)	29
6.5 Effect of Temperature on the Separation of Monosaccharides Using Dionex CarboPac PA10 (4 × 250 mm) and Manually Prepared Eluent:.....	30
6.6 Effect of Temperature on the Separation of Monosaccharides Using Dionex CarboPac PA10 (4 × 250 mm) and EGC:	31
6.7 Effect of Temperature on the Separation of Monosaccharides Using Dionex CarboPac PA10 (0.4 × 250 mm) and EGC:	32
6.8 Comparison of Silver/Silver chloride and PdH Reference Electrodes Using CarboPac PA10 (0.4 × 250 mm) column	33
6.9 Monosaccharide Composition Analysis of Fetuin Hydrolysate Using Dionex CarboPac PA10 (4 × 250 mm):	34
6.10 Monosaccharide Composition Analysis of Fetuin Hydrolysate Using Dionex CarboPac PA10 (0.4 × 250 mm):	35
6.11 Effect of AminoTrap Column on Monosaccharide Composition Analysis of Fetuin Hydrolysate Using AminoTrap Column Coupled with Dionex CarboPac PA10 (4 × 250 mm):.....	36
6.12 Effect of BorateTrap on the Peak Shape of Monosaccharides Using Dionex CarboPac PA10 (2 × 250 mm):	37

7. Troubleshooting Guide	38
7.1 High Background.....	38
7.2 Decreased Detection Sensitivity	39
7.3 Column Problems	39
7.3.1 Excessive Gradient Rise.....	39
7.3.2 Peak Efficiency and Resolution are Decreasing.....	40
7.4 System Problems	40
7.4.1 High Detection Background Caused by the System.....	40
7.4.2 No Peaks, Poor Peak Area Reproducibility or too Small Peak Areas	40
7.4.3 Large Baseline Dip in the Chromatogram.....	40
7.4.4 Incorrect or Variable Retention Times	41
7.4.5 Unidentified Peaks Appear with Expected Analyte Peaks	41
7.5 Sodium Hydroxide Cleanup	42
7.6 Reconditioning or Replacement of the Gold (conventional or disposable) Electrodes or Replacement of the Reference Electrode.....	42

1. Introduction

The Thermo Scientific™ Dionex™ CarboPac™ family of columns is designed to address the analytical requirements of a wide range of carbohydrate chemists. Underivatized carbohydrates are separated at high pH, in an approach that is unique to Thermo Scientific, simple to reproduce, and made possible by the pH stability of the Dionex CarboPac columns. The Dionex CarboPac PA10 (0.4 mm, 2 mm and 4 mm) capillary/analytical columns are recommended for monosaccharide composition analysis. It had been the best column to combine with the Thermo Scientific Dionex AminoTrap™ for glycoprotein monosaccharide composition analysis, before the introduction of the Dionex CarboPac PA20 column.

The Dionex AminoTrap column removes the problematic amino acids out of the chromatogram, thereby eliminating a possibility of their co-elution with carbohydrates. The Dionex CarboPac PA10 also works well in combination with the Dionex AminoTrap and EGC eluent generator cartridge for monosaccharide analysis. For detailed information on Dionex CarboPac PA20, AminoTrap column and EGC, refer to the product manual Document No. 031884, 065362 (CPPA20), 031197 (AmionTrap) and 065018 (EGC).

Resin Characteristics:

Particle Size:	10 µm
Pore Size:	microporous (< 10 Å)
Cross-linking:	55%
Ion exchange capacity:	100 µeq per 4x250 mm column 25 µeq per 2x250 mm column 1 µeq per 0.4x250 mm column

Latex Characteristics:

Functional Group:	difunctional quaternary ion
Latex Diameter:	460 nm
Latex Cross-linking:	5%

Typical Operating Parameters:

pH range:	0–14
Temperature Limit:	4–60 °C
Pressure Limit:	5000 psi
Organic Solvent Limit:	0–90% for cleaning only
Typical eluents:	High purity water (18.2 megaohm-cm), potassium hydroxide, sodium hydroxide, sodium acetate

2. System Requirements and Installation

2.1 System Requirements

2.1.1 System Requirements for 0.4 mm, 2 mm and 4 mm Operation

The carbohydrate separations using the Dionex CarboPac PA10 columns are optimized for use with Dionex Ion Chromatography systems equipped with electro chemical detection. It is highly recommended to ensure that the systems used for carbohydrate analysis are metal-free.

2.1.2 Installation of Disposable Electrode into an ED50 Cell, pH-Ag/AgCl Reference Electrode or PdH Reference Electrode

The 2 mil-thick Teflon gaskets included in each package of disposable electrodes must be used (Note: 1 mil-thick Teflon gaskets for use with capillary flow rates have to be ordered separately, PN 072117); otherwise, the disposable electrode product warranty is void. In addition, the quadruple waveform must be used for carbohydrate analysis otherwise the product warranty is void. Always wear gloves when handling electrodes. Never touch the electrode surface. To install a disposable working electrode and reference electrode (pH-Ag/AgCl or PdH) refer to Product Manual for Disposable Electrodes Doc. No. 065040, ICS-5000 Ion Chromatography System Manual Doc. No. 065342 and User's Compendium for Electrochemical Detection Doc. No. 065340.

2.1.3 System Void Volume

When using CPPA10 columns, it is particularly important to minimize system void volume. The system void volume for 2 mm columns should be scaled down to at least 1/4 of the system volume in a standard system designed for 4 mm columns (4 mm system). For best performance, all of the tubing installed between the injection valve and detector should be 0.0025" (P/N 071870) i.d. PEEK tubing (for pre-cut tubing for the capillary column, see [Section 2.5](#)) for 0.4mm columns, 0.005" (P/N 044221) i.d. PEEK tubing for 2mm columns and 0.010" i.d. PEEK tubing (P/N 042260) for 4mm columns. Minimize the lengths of all connecting tubing and remove all unnecessary switching valves and couplers.

2.2 The Injection Loop

2.2.1 The 4 mm System Injection Loop, 10 - 50 μ L

For most applications on a 4 mm analytical system, a 10 – 50 μ L injection loop is sufficient. Generally, you should not inject more than 40 nanomoles of any analyte onto the 4 mm analytical column. Injecting larger amounts of an analyte can result in overloading the column which can affect the detection linearity. For low concentrations, larger injection loops can be used to increase sensitivity.

2.2.2 The 2 mm System Injection Loop, 2 - 15 μ L

For most applications on a 2 mm analytical system, a 2 – 15 μ L injection loop is sufficient. Generally, you should not inject more than 10 nanomoles of any analyte onto a 2 mm analytical column. Injecting larger amount of an analyte can result in overloading the column which can affect the detection linearity. For low concentrations, larger injection loops can be used to increase sensitivity. The Dionex CarboPac PA10 2 mm requires a microbore HPLC system configuration. Install an injection loop one-fourth or less (<15 μ L) of the loop volume used with a 4 mm analytical system.

2.2.3 The 0.4 mm System Injection Loop, 0.4 µL Internal Loop

For most applications on a 0.4 mm capillary system, a 0.4 µL injection loop is sufficient. Generally, do not inject more than 0.5 nanomoles of any analyte into a 0.4 mm capillary column. Injecting larger amounts of an analyte can result in overloading the column, which can affect the detection linearity. For samples containing low concentrations of analytes, larger external injection loops can be used to increase sensitivity.

2.3 The Dionex CarboPac PA10 Guard Column

A Dionex IonPac CarboPac PA10 Guard Column is normally used with the CarboPac PA10 Analytical/Capillary Column. Retention times will increase by approximately 20% when a guard column is placed in-line before the analytical/capillary column under isocratic conditions. A guard column is utilized to prevent sample contaminants from eluting onto the analytical/capillary column. It is easier to clean or replace a guard column than an analytical/capillary column. Replacing the Dionex CarboPac PA10 Guard Column at the first sign of peak efficiency loss or decreased retention time will prolong the life of the Dionex CarboPac PA10 Analytical/Capillary Column.

2.4 Installing the Dionex CR-ATC Trap Column for Use with Dionex EGC

For Dionex IonPac CarboPac PA10 applications using the Dionex EGC KOH cartridge, a Dionex CR-ATC Continuously Regenerated Trap Column (P/N 060477 or 072078) should be installed at the Dionex EGC eluent outlet to remove trace level anionic contaminants from the carrier deionized water. See the Dionex CR-TC Product Manual (Document No. 031910) for instructions.

2.5 Installation of the Capillary Column

1. Before installing the new separator column, cut off the column label and slide it into the holder on the front of the cartridge (see [Figure 6](#)).
2. For reference, Figure 1 shows the column cartridge after installation of both a capillary guard column and a capillary separator column. [Figure 2](#) shows the column cartridge after installation of only a capillary separator column.

Figure 1 Separator and Guard Columns Installed in Column Cartridge

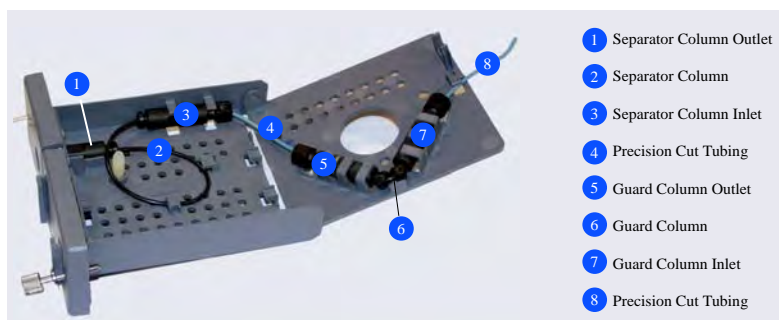
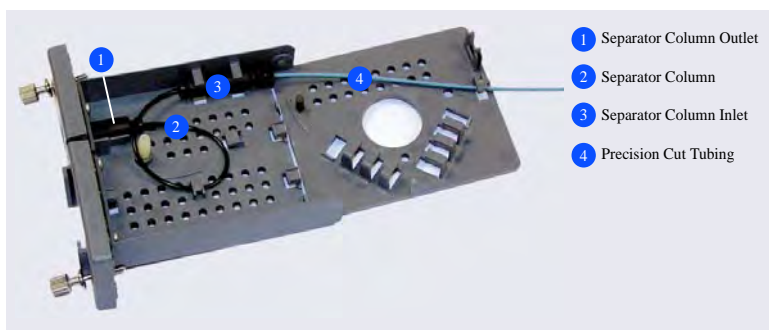

Figure 2 Separator Column Only Installed in Column Cartridge



3. Locate the Dionex IC Cube Tubing Kit (P/N 072186) that is shipped with the Dionex IC Cube. The tubing kit includes the following items:

Table 1 Contents of the Dionex IC Cube Tubing Kit (P/N 072186)

Part	Length / Quantity	Part Number	Used To Connect
Precision cut 0.062 mm (0.0025-in) ID PEEK tubing, blue	65 mm (2.56 in)	072188	50 mm guard column outlet to 250 mm separator column inlet
Precision cut 0.062 mm (0.0025-in) ID PEEK tubing, blue, labeled VALVE PORT 3	115 mm (4.53 in)	072189	Guard column inlet to injection valve
Precision cut 0.062 mm (0.0025-in) ID PEEK tubing, blue	75 mm (2.93 in)	074603	35 mm guard column outlet to 150 mm separator column inlet
Precision cut 0.062 mm (0.0025-in) ID PEEK tubing, blue, labeled VALVE PORT 3	210 mm (8.27 in)	072187	Separator column inlet to injection valve (if a guard column is not present)
0.25 mm (0.010-in) ID PEEK tubing, black	610 mm (24 in)	042690	EG degas cartridge REGEN OUT to waste (if an EG is not present)
Fitting bolt, 10-32 hex double-cone (smaller), black	3	072949	Connect precision cut 0.062 mm (0.0025-in) ID PEEK tubing
Fitting bolt, 10-32 double-cone (larger), black	1	043275	Connect 0.25 mm (0.010-in) ID PEEK tubing (black)
Ferrule fitting, 10-32 double-cone, tan	4	043276	Use with both sizes of fitting bolts

2 – System Requirements and Installation

4. Refer to the following figures for the precision cut tubing required for your configuration:

Figure 3 Tubing Connections for 250 mm Separator Column and 50 mm Guard Column

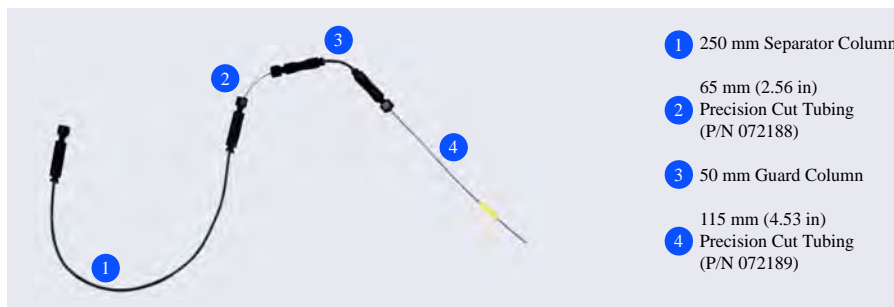

Figure 4 Tubing Connections for Separator Column Only



5. Lift up the lid of the column cartridge to open it.
6. Remove the fitting plug from the outlet fitting on the separator column. Orient the fitting with a flat side up (see Figure 5) and push the fitting into the opening at the front of the column cartridge until it stops.

Figure 5 Column Outlet Fitting Installed in Column Cartridge



7. Coil the separator column tubing inside the cartridge as shown in Figure 1 or Figure 2. Secure the column tubing and the inlet fitting in the clips on the column cartridge.
8. Secure the inlet and outlet fittings on the guard column (if used) in the column clips on the lid of the column cartridge.
9. Route the guard column inlet tubing (if used) or the separator column inlet tubing through the clip on the top edge of the column cartridge lid.
10. Close the lid (you should hear a click) and route the tubing into the slot on the front of the column cartridge (see Figure 6).



NOTE

If the columns are installed correctly, the cartridge lid snaps closed easily. If the lid does not close easily, do not force it. Open the lid and verify that the columns and tubing are installed correctly and secured in the clips.

Figure 6 Column Cartridge Closed

- 1 Separator Column Outlet
- 2 Column Inlet Tubing



2.6 Eluent Storage

Dionex CarboPac PA10 columns are designed to be used with hydroxide eluent systems. Storage under a helium atmosphere ensures contamination free operation and proper pump performance (nitrogen can be used if eluents do not contain solvents).



NOTE

For assistance, contact Technical Support for Thermo Scientific Dionex Products. In the U.S., call 1-800-346-6390. Outside the U.S., call the nearest Thermo Fisher Scientific office.

3. Purity Requirements for Chemicals

Obtaining reliable, reproducible and accurate results requires eluents that are free from impurities and prepared only from the chemicals recommended below. Thermo Scientific cannot guarantee proper column performance when alternate suppliers of chemicals or lower purity water are utilized.

3.1 Deionized Water

The deionized water used to prepare eluents should be Type I reagent grade water with a specific resistance of 18.2 megaohm-cm. The water should be free from ionized impurities, organics, microorganisms and particulate matter larger than 0.2 μm . The availability of UV treatment as a part of the water purification unit is recommended. Follow the manufacturer's instructions regarding the replacement of ion exchange and adsorbent cartridges. All filters used for water purification must be free from electrochemically active surfactants. Expanding their period of use beyond the recommended time may lead to bacterial contamination and as a result, a laborious cleanup may be required. Use of contaminated water for eluents can lead to high background signals and gradient artifacts.

3.2 Sodium Hydroxide

Use 50% w/w sodium hydroxide (Certified Grade, Fischer Scientific P/N UN 1824) for preparation.

3.3 Sodium Acetate

Thermo Scientific highly recommends the use of Dionex Sodium Acetate Reagent (P/N 059326) for carbohydrate analysis. Thermo Scientific cannot guarantee proper detection performance when different grades or alternate suppliers of sodium acetate are utilized.

4. Before You Start

4.1 The Most Important Rules

- | | |
|--------|--|
| ALWAYS | use 50% NaOH solution rather than NaOH pellets to make eluents |
| ALWAYS | use dedicated glassware and disposable glass or plastic ware for volume adjustments. |
| ALWAYS | keep your NaOH eluent blanketed with helium or nitrogen. Prepare new NaOH eluent if left unblanketed for more than 30 minutes. |
| ALWAYS | use EGC-KOH generated eluent when possible to avoid any eluent preparation issues |
| ALWAYS | pull at least 40 mL of new eluent through the lines when changing eluent or adding fresh eluent. This will ensure that your fresh eluent is primed through the lines up to the pump heads. |
| ALWAYS | verify the equilibration time necessary prior to injection to avoid baseline issues or artifacts or to avoid unnecessary increase in total method time. |
| NEVER | go to the next step of the installation if the previous step has failed. |
| NEVER | start an installation with any of the check list items below missing |
| NEVER | use ‘communal’ filtration units or filters made of unknown or unsuitable (cellulose derivatives, polysulfone) materials. |
| NEVER | use MeOH or other organic solvents as rinse fluid in the autosampler. Use only water, replaced daily. |
| NEVER | run above 60°C or 5000 psi. |

4.2 Initial Check List

These items **MUST** be available in your lab. The absence of any of these may compromise your analysis.

- Laboratory water unit delivering 18.2 megaohm-cm water at the installation site.
- Vacuum pump available for use with the vacuum filtration units.
- Sterile packed Nalgene Filtration units (pore size: 0.2 μm , filtered material: Nylon), 1 L funnel size
- Inert gas cylinder (helium or nitrogen) with a regulator valve (ca. 0–200 psi at the low pressure side) and the appropriate size adaptors plus tubing.
- Sterile-packed 10 mL and 25 mL disposable pipets and suitable pipeting bulbs or pumps.
- Disposable, plastic (PE) large-size (at least 20 mL) syringe for priming the pump.
- Plastic eluent bottles.

5. Preparation of Eluents and Standards



NOTE

Always sanitize the entire analyzer with 2M NaOH prior to initial start-up and after idle periods.

For the monosaccharide compositional analysis, it is not necessary to prepare Eluent 4.

Obtaining reliable, consistent and accurate results requires eluents that are free from ionic and electrochemically active impurities. Chemicals and deionized water used to prepare eluents must be of the highest purity available. Maintaining low trace impurities and low particle levels in eluents also help to protect your ion exchange columns and system components. Thermo Scientific cannot guarantee proper column performance when the quality of the chemicals, solvents and water used to prepare eluents is substandard.

5.1 Eluent E1: Deionized Water

Vacuum degas the water by placing the eluent reservoir in a sonicator and drawing a vacuum on the filled reservoir with a vacuum pump. Vacuum degas the reservoir for 5–10 minutes while sonicating. Note: Degassing by vacuum filtration through a 0.2 μm filter is a good alternative to degassing in a sonicator. Cap each bottle after the degassing step and minimize the length of time the bottle is opened to the atmosphere.

5.2 Eluent E2, E3: 0.018 M / 1 M Sodium Hydroxide



NOTE

DO NOT prepare NaOH eluents from sodium hydroxide pellets! The pellets are coated with a layer of carbonate.

Always store degassed NaOH eluents in plastic eluent bottles blanketed with helium or nitrogen to avoid carbon dioxide contamination from the air. Carbonate in the eluent can significantly reduce retention times for carbohydrates.

5.2.1 Sodium Hydroxide Eluent Concentration

Weight Method

When formulating eluents from 50% sodium hydroxide, Thermo Scientific recommends weighing out the required amount of 50% sodium hydroxide. Use the assayed concentration value from the sodium hydroxide bottle.

Example: To make 1 L of 1 M NaOH use 80.02g of 50% sodium hydroxide:

$$\text{For 1 M: } \frac{1 \text{ mole/L} \times 40.01 \text{ g/mole}}{50\%} = 80.02 \text{ g diluted to 1 L}$$

Volume Method

Although it is more difficult to make precise carbonate-free eluents for gradient analysis volumetrically, you may choose to use the following formula to determine the correct volume of 50% sodium hydroxide to be diluted.

$$g = dvr$$

Where

- g = weight of sodium hydroxide required (g)
- d = density of concentrated solution (g/mL)
- v = volume of the 50% sodium hydroxide required (mL)
- r = % purity of the concentrated solution

Example: To make 1 L of 1M NaOH use 52.3 mL of 50% sodium hydroxide:

$$\text{For 1 M: } \frac{1 \text{ mole/L} \times 40.01 \text{ g/mole}}{50\% * 1.53^* \text{ g/mL}} = 52.3 \text{ mL diluted to 1 L}$$

* This density applies to 50% NaOH. If the concentration of the NaOH solution is significantly different from 50% the upper (weight method) calculation should be used instead.

Sodium Hydroxide Eluents

Dilute the amount of 50% (w/w) NaOH Reagent specified in [Table 2](#) “Dilution of 50% (w/w) NaOH to 50% * 1.53* g/m Make Standard CPPA10 Eluents” with degassed, dionized water (18.2 megohm-cm) to a final volume of 1,000 mL using a volumetric flask. Avoid the introduction of carbon dioxide from the air into the aliquot of 50% (w/w) NaOH bottle or the deionized water being used to make the eluent. Do not shake the 50% (w/w) NaOH bottle or pipette the required aliquot from the top of the solution where sodium carbonate may have formed.

Table 2 Mass or Volume of NaOH Required to Make 1 L of Common Eluents

Eluent Concentration (M)	NaOH (g)	NaOH (mL)
0.018	1.44	0.941
0.1	8.0	5.2
0.5	40.0	26.2
0.8	64.0	41.8
1.0	80.0	52.3

5.3 Eluent E4: 100 mM Sodium Hydroxide/ 1 M Sodium Acetate

To maintain baseline stability, it is important to keep the sodium hydroxide concentration constant during the sodium acetate gradient, because acetate has no buffering capacity at high pH. This is achieved by making the eluents as follows:

Eluent A: x mM NaOH
 Eluent B: x mM NaOH, y mM NaOAc

To make one (1) liter of 0.1 M sodium hydroxide/ 1.0 M sodium acetate, dispense approximately 800 mL of DI water into a 1 L volumetric flask. Vacuum degas for approximately 5 minutes. Add a stir bar and begin stirring. Weigh out 82.0 g anhydrous, crystalline sodium acetate (Thermo Scientific Dionex Sodium Acetate Reagent, P/N 059326). Add the solid acetate steadily to the briskly stirring water to avoid the formation of clumps which are slow to dissolve. Once the salt has dissolved, remove the stir bar with a magnetic retriever. Add DI water to the flask to bring the volume to the 1 L mark.

Vacuum filter the solution through a 0.2 μ m Nylon filter. This may take a while as the filter may clog with insoluble material from the sodium acetate. Using a plastic tip volumetric pipet, measure 5.2 mL of 50% (w/w) sodium hydroxide solution. Dispense the sodium hydroxide solution into the acetate solution about 1 inch under the surface of the acetate solution. The eluent should be kept blanketed under helium or nitrogen at 34 to 55 kPa (5–8 psi) at all times, and last about 1 week.



NOTE

Thermo Scientific recommends the use of dedicated glassware, pipets and filtration apparatus for exclusive use in the preparation of carbohydrate eluents.

5.4 Sample Preparation

The Dionex CarboPac columns are strong anion exchangers. Thus, the normal caveats applicable to ion exchange chromatography apply to these columns. High salt concentrations in the samples should be avoided wherever possible. Special care should be taken with samples containing high concentrations of anions, which are strong eluents for the Dionex CarboPac columns (e.g. chloride, carbonate, phosphate, etc.). It is best to avoid extremes of sample pH (especially extremely acidic samples). The presence of anionic detergents (e.g., SDS) in samples should be avoided entirely. Nonionic or cationic detergents may be acceptable in low concentrations.

Matrix Interferent	Effect	Possible Removal
Hydroxylated compounds (e.g. Tris buffers, alcohols)	PED-active (interferes with carbohydrate detection)	Dialysis dilution
Halides	Will bind to column, may affect retention time of analytes and interact with gold electrode.	Dialysis, dilution, or solid-phase extraction using Thermo Scientific Dionex OnGuard Ag (silver) cartridge.
Amine-containing compounds (including proteins, peptides and free amino acids).	PED active	Solid-phase extraction using Dionex OnGuard A (anion-exchange). For inline use, the Dionex AminoTrap column is used for proteins, peptides and amino acids.
Lipids	May foul column	Liquid-liquid extraction or supercritical fluid extraction.
Organic solvents	May affect analyte retention and cause diminished electrode response.	Solid-phase extraction using Dionex OnGuard RP (reverse phase).
Anionic detergents (such as SDS)	Will bind irreversibly to the column.	Solid-phase extraction using Dionex OnGuard RP.

When using pulsed electrochemical detection (PED) for detection, beware of high concentrations of electrochemically-active components (e.g., TRIS buffer, alcohols, and other hydroxylated compounds). Small amounts of organic solvents in the sample will not harm the column, although the organics may interfere with the chromatography or detection of the analytes of interest. If necessary, samples may be treated with reversed phase or ion exchange cartridges (such as the Dionex OnGuard cartridges) before analysis. However, because the Dionex CarboPac columns are extremely rugged, it is often worthwhile to analyze an aliquot of the sample directly, without any pre-column cleanup.

Sample matrices in glycoprotein analysis can be greatly simplified by performing a Western blot and selectively removing the carbohydrates from the PVDF membrane-bound proteins. Please ask for Dionex **Technical Note 30**, “Monosaccharide and Oligosaccharide Analysis of Glycoproteins Electrotransferred onto Polyvinylidene Fluoride (PVDF) membranes,” or retrieve it from our Web site at www.thermoscientific.com.

5.5 Verification of System Cleanliness

Prepare a new set of eluents as described in [Sections 5.1](#) and [5.2](#) and fill the eluent bottles. Set the eluent composition to 100% for each eluent line and draw out at least 40 mL of eluent from each eluent line.

5.5.1 System Background Check

This procedure is performed using the conditions of the test chromatogram. Make sure that

- A. the cell is not yet on,
- B. the pump is pumping 100 mM NaOH, 50 mM NaOAc or 200mM KOH at 0.5 mL/min,
- C. a length of yellow tubing is installed between the injector and detector cell to generate ~1000 psi backpressure,
- D. the columns are not yet installed.

Confirm that the pH is between 12.8 and 13.4. With the pH within this range, turn on the cell using the quadruple waveform (See Table 3, Section 6.3 Disposable Electrode Manual, document number 065040) and begin monitoring the background signal from the control panel for at least 30 minutes. Confirm that the baseline is < 30 nC. If the background > 30 nC or the pH is out of range, see the “Troubleshooting” section at the end of this manual.

5.5.2 Verification of Column Cleanliness

Install the Dionex CarboPac PA10 column set only after the initial system test determines a background level within the specified range. A premature installation on a contaminated system will cause delays during the column equilibration.

The Dionex CarboPac PA10 is shipped in 18mM NaOH. Any column that is stored long-term should be stored in the same solution. To prepare the column for standard analysis, the Dionex CarboPac PA10 must be washed for at least one hour (two hours preferred) with 200mM KOH or NaOH at appropriate flow rate. Equilibrate the column set by performing two blank injections (DI water) under the test chromatogram conditions, including the column regeneration and re-equilibration steps.

Once the columns are equilibrated, inject a system suitability standard such as the column's QAR standard, to establish the performance of the column at start-up. This chromatogram can then be referred to when troubleshooting your system. Once you obtain your expected chromatography, you are ready to proceed to running your application.

Dionex recommends that the system suitability standard be run whenever you reinstall a column after long-term storage.

6. Applications

The following section provides an example of the types of applications for which the Dionex CarboPac PA10 is designed. The chromatograms in this section were obtained using columns that reproduced the Quality Assurance Report on an optimized Ion Chromatograph. Different systems will differ slightly in performance due to slight differences in column set, system voids volumes, liquid sweep-out times of different components and laboratory temperatures.

Also, note that a different equilibration time may be necessary prior to injection in order to achieve stable baseline throughout the run. The equilibration time prior to injection depends on other factors such as system voids volumes and liquid sweep-out times of different components. It is recommended to optimize the equilibration time based on the strong wash, elution eluent, system voids volumes and liquid sweep-out times of different components.



CAUTION

Pumping pure water through the Dionex CarboPac PA10 will cause irreversible damage to the bed.

6.1 Production Test Chromatograms Using Manually Prepared Eluent

Isocratic separation of monosaccharide standard on the CPPA10 Analytical/Capillary Column has been optimized utilizing a hydroxide eluent and can be used to test the performance of the CPPA10 Column. The CPPA10 Analytical Column should always be used with the CPPA10 Guard Column; the addition of the Guard column increases elution time by ~20% when compared to the Analytical Column by itself. To guarantee that all CPPA10 Analytical Columns meet high quality and reproducible performance specification standards, all columns undergo the following production control test at room temperature (22°C). However, for most applications an operating temperature of 30°C is recommended to ensure reproducible resolution and retention.

Figure 7 CarboPac PA10 2 mm With and Without Guard Column: Separation of Monosaccharide Standard

Column: Dionex CarboPac PA10 (2 × 50mm)
 Dionex CarboPac PA10 (2 × 250mm)
Eluent : A – 200 mM NaOH
 B – 18 mM NaOH
Temperature: 30°C
Flow Rate: 0.25 mL/min
Inj. Volume: 2.5µL
Detection: Integrated Amperometry, quadruple pulse waveform
Working Electrode: PTFE Gold, disposable electrode
Reference Electrode: Ag/AgCl
Diluted Standard: 50 nmol/mL (with DI water)

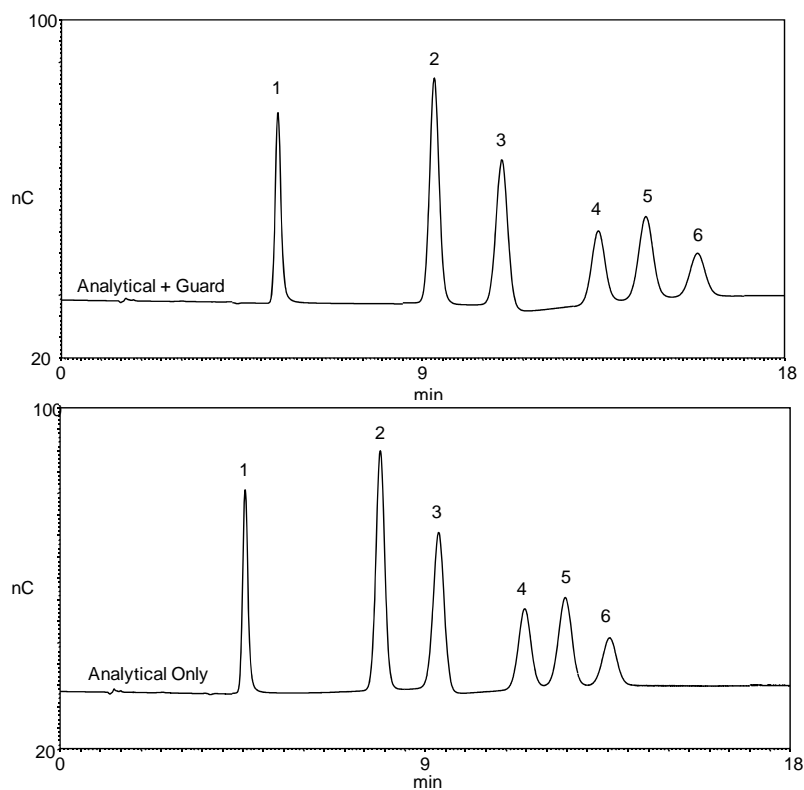

Eluent Program

Time	%A	%B	Comments
-35	100	0	Cleaning
-20	100	0	
-19.9	0	100	Equilibration
0	0	100	Load/inject
20	0	100	

Peaks

1. Fucose
2. Galactosamine
3. Glucosamine
4. Galactose
5. Glucose
6. Mannose

Figure 8 CarboPac PA10 4 mm With and Without Guard Column: Separation of Monosaccharide Standard

Column: Dionex CarboPac PA10 (4 × 50mm)
 Dionex CarboPac PA10 (4 × 250mm)
Eluent : A – 200 mM NaOH
 B – 18 mM NaOH
Temperature: 30°C
Flow Rate: 1.0 mL/min
Inj. Volume: 10µL
Detection: Integrated Amperometry, quadruple pulse waveform
Working Electrode: PTFE Gold, disposable electrode
Reference Electrode: Ag/AgCl
Diluted Standard: 50 nmol/mL (with DI water)

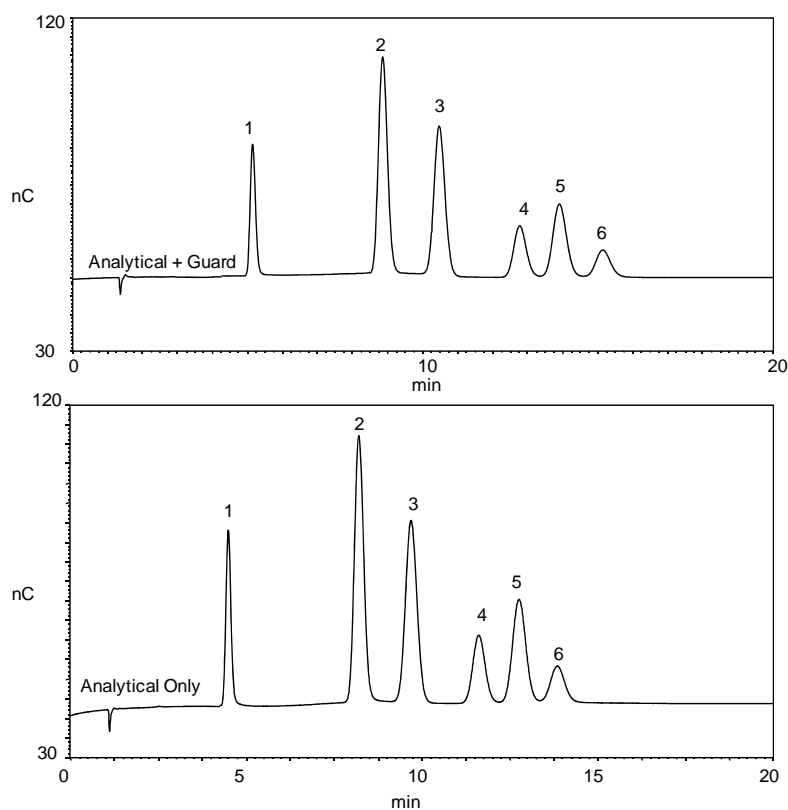

Eluent Program

Time	%A	%B	Comments
-35	100	0	Cleaning
-20	100	0	
-19.9	0	100	Equilibration
0	0	100	Load/inject
20	0	100	

Peaks

1. Fucose
2. Galactosamine
3. Glucosamine
4. Galactose
5. Glucose
6. Mannose

6.2 Production Test Chromatograms Using Eluent Generator

Isocratic separation of monosaccharide standard on the CPPA10 Analytical/Capillary Column has been optimized utilizing EGC generated potassium hydroxide eluent and can be used to test the performance of the CPPA10 Column. The CPPA10 Analytical Column should always be used with the CPPA10 Guard Column; the addition of the Guard Column increases elution time by ~20% when compared to the Analytical Column by itself. To guarantee that all CPPA10 Analytical Columns meet high quality and reproducible performance specification standards, all columns undergo production control test at room temperature (22°C). However, for most applications an operating temperature of 30°C is recommended to ensure reproducible resolution and retention.

Figure 9 CarboPac PA10 4 mm: With and Without Guard Column Using Eluent Generator

Column: Dionex CarboPac PA10 (4 × 50mm)
Dionex CarboPac PA10 (4 × 250mm)
Eluent : Cleaning Eluent – 100 mM KOH
Elution Eluent – 18 mM KOH
Eluent Source: Dionex EGC-KOH Cartridge
Temperature: 22°C
Flow Rate: 1.0 mL/min
Inj. Volume: 10µL
Detection: Integrated Amperometry, quadruple pulse waveform
Working Electrode: PTFE Gold, disposable electrode
Reference Electrode: Ag/AgCl
Diluted Standard: 50 nmol/mL (with DI water)

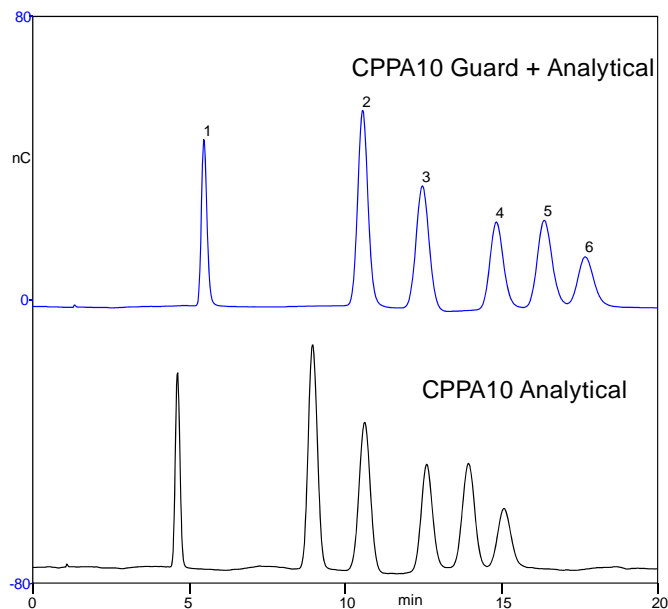

Eluent Program

Time	KOH Concentration (mM)	Comments
-35	100	Strong Wash
-20	100	
-19.9	18	Equilibration
0	18	Load/Inject
20	18	

Peaks

1. Fucose
2. Galactosamine
3. Glucosamine
4. Galactose
5. Glucose
6. Mannose

Figure 10 CarboPac PA10 0.4 mm: With and Without Guard Column Using Eluent Generator

Column: Dionex CarboPac PA10 (0.4 × 50mm)
 Dionex CarboPac PA10 (0.4 × 250mm)
Eluent : Cleaning Eluent – 100 mM KOH
 Elution Eluent – 18 mM KOH
Eluent Source: Dionex EGC-KOH (Capillary) Cartridge
Temperature: 22°C
Flow Rate: 10 µL/min
Inj. Volume: 0.4µL
Detection: Integrated Amperometry, quadruple pulse waveform
Working Electrode: PTFE Gold, disposable electrode
Reference Electrode: Ag/AgCl
Diluted Standard: 12.5 nmol/mL (with DI water)

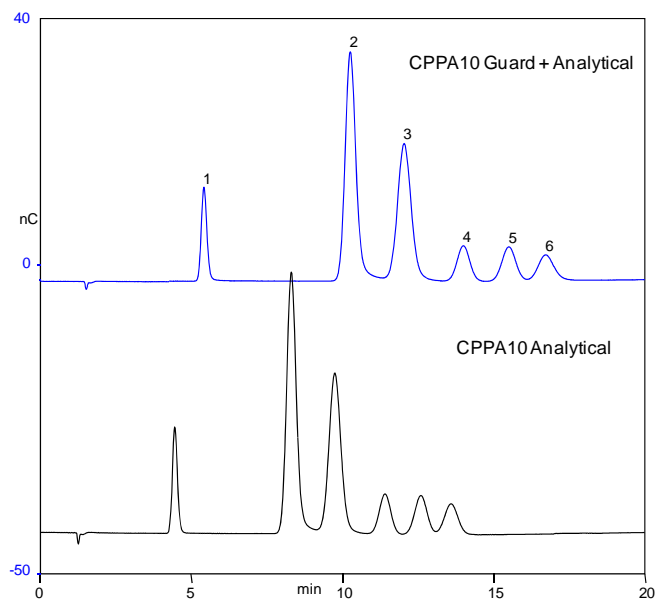

Eluent Program

Time	KOH Concentration (mM)	Comments
-40	100	Strong Wash
-25	100	
-24.9	18	Equilibration
0	18	Load/Inject
20	18	

Peaks

1. Fucose
2. Galactosamine
3. Glucosamine
4. Galactose
5. Glucose
6. Mannose

6.3 Effect of Flow Rate on the Monosaccharide Analysis Using Dionex CarboPac PA10 (4 × 250 mm)

The Dionex CarboPac PA10 is capable of withstanding pressures up to 5,000 psi. The following chromatogram shows the separation of six monosaccharide in less than 12 minutes at a flow rate of 1.5 mL/min.

Figure 11 Effect of Flow Rate on the Analysis Time Using Dionex CarboPac PA10 (4 × 250 mm)

Column: Dionex CarboPac PA10 (4 × 50mm)
Dionex CarboPac PA10 (4 × 250mm)
Eluent: A – 200 mM NaOH
B – 18 mM NaOH
Temperature: 30°C
Flow Rate: See Chromatogram
Inj. Volume: 10µL
Detection: Integrated Amperometry, quadruple pulse waveform
Working Electrode: PTFE Gold, disposable electrode
Reference Electrode: Ag/AgCl
Diluted Standard: (50 nmol/mL / DI Water)

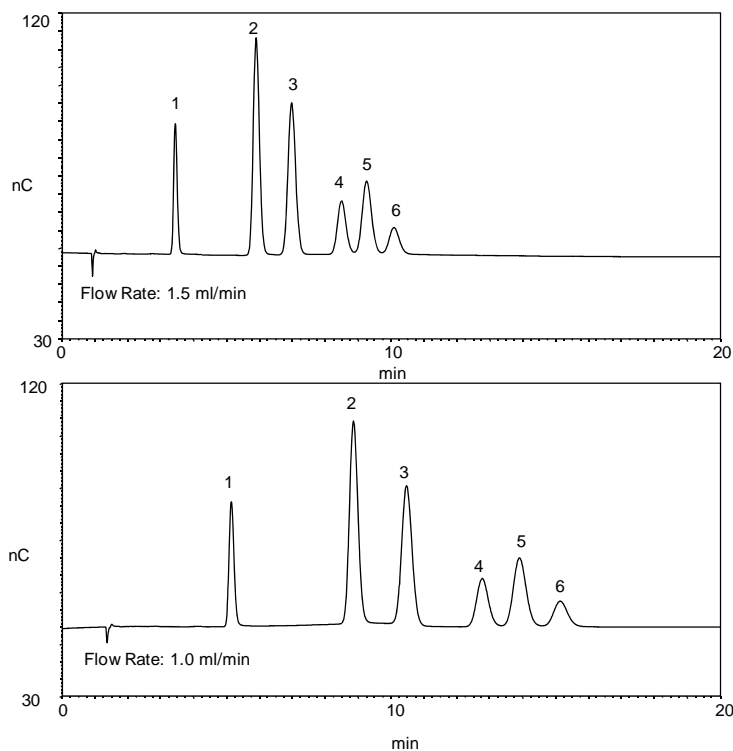

Eluent Program

Time	%A	%B	Comments
-30	100	0	Cleaning
-15	100	0	
-14.9	0	100	Equilibration
0	0	100	Load/inject
20	0	100	

Peaks

1. Fucose
2. Galactosamine
3. Glucosamine
4. Galactose
5. Glucose
6. Mannose

6.4 Effect of Flow Rate on the Monosaccharide Analysis Using Dionex CarboPac PA10 (0.4 × 250 mm)

The following chromatogram shows the separation of six monosaccharides in less than 12 minutes at a flow rate of 15 $\mu\text{L}/\text{min}$ using 0.4 mm CarboPac PA10 capillary column.

Figure 12 Effect of Flow Rate on the Analysis Time Using Dionex CarboPac PA10 (0.4 × 250 mm)

Column: Dionex CarboPac PA10 (0.4 × 250 mm)
Dionex CarboPac PA10 (0.4 × 250 mm)
Eluent: Cleaning Eluent – 100 mM KOH
Elution Eluent – 18 mM KOH
Eluent Source: Dionex EGC-KOH (Capillary) Cartridge
Temperature: 30°C
Flow Rate: See Chromatogram
Inj. Volume: 0.4 μL
Detection: Integrated Amperometry, quadruple pulse waveform
Working Electrode: PTFE Gold, disposable electrode
Reference Electrode: Ag/AgCl
Diluted Standard: (12.5 nmol/mL / DI Water)

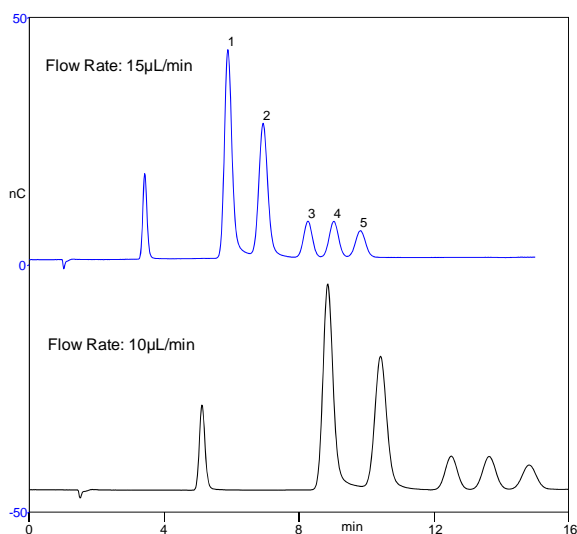

Eluent Program

Flow Rate: 15 $\mu\text{L}/\text{min}$

Time	KOH Concentration (mM)	Comments
-28	100	Strong Wash
-18	100	
-17.9	18	Equilibration
0	18	Load/Inject
15	18	

Flow Rate: 10 $\mu\text{L}/\text{min}$

Time	KOH Concentration (mM)	Comments
-35	100	Strong Wash
-25	100	
-24.9	18	Equilibration
0	18	Load/Inject
20	18	

Peaks

1. Fucose
2. Galactosamine
3. Glucosamine
4. Galactose
5. Glucose
6. Mannose

6.5 Effect of Temperature on the Separation of Monosaccharides Using Dionex CarboPac PA10 (4 × 250 mm) and Manually Prepared Eluent:

The Dionex CarboPac PA10 is capable of withstanding wide range of temperatures. However, temperature does affect the column selectivity. The following chromatogram shows the separation of six monosaccharides at 22°C and at 30°C using a manually prepared eluent and CarboPac PA10 4 mm column. Note that 30°C is an optimum temperature for the separation of galactose, glucose and mannose.

Figure 13 Effect of Temperature on the Separation of Monosaccharide Standard Using Dionex CarboPac PA10 (4 × 250 mm)

Column: Dionex CarboPac PA10 (4 × 50 mm)
Dionex CarboPac PA10 (4 × 250 mm)

Eluent: A – 200 mM NaOH
B – 18 mM NaOH

Temperature: See Chromatogram

Flow Rate: 1.0 mL/min

Inj. Volume: 10 µL

Detection: Integrated Amperometry, quadruple pulse waveform

Working Electrode: PTFE Gold, disposable electrode

Reference Electrode: Ag/AgCl

Diluted Standard: (50 nmol/mL / DI Water)

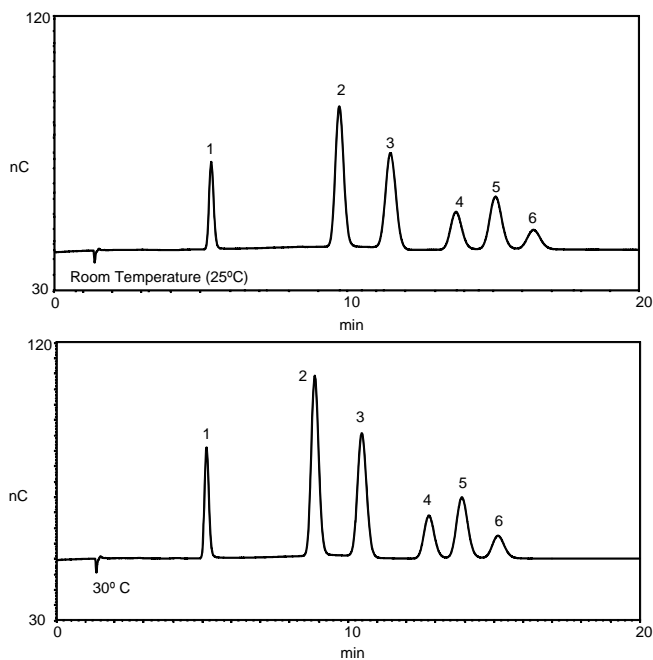

Eluent Program

Time	%A	%B	Comments
-30	100	0	Cleaning
-15	100	0	
-14.9	0	100	Equilibration
0	0	100	Load/inject
20	0	100	

Peaks

1. Fucose
2. Galactosamine
3. Glucosamine
4. Galactose
5. Glucose
6. Mannose

6.6 Effect of Temperature on the Separation of Monosaccharides Using Dionex CarboPac PA10 (4 × 250 mm) and EGC:

The Dionex CarboPac PA10 is capable of withstanding wide range of temperatures. However, temperature does affect the column selectivity. The following chromatogram shows the separation of six monosaccharides at 22°C and at 30°C using EGC generated eluent and CarboPac PA10 4 mm. Note that 30°C is an optimum temperature for the separation of Galactose, Glucose and Mannose.

Column: Dionex CarboPac PA10 (4 × 50 mm)
Dionex CarboPac PA10 (4 × 250 mm)

Eluent: Cleaning Eluent – 100 mM KOH
Elution Eluent – 18 mM KOH

Eluent Source: Dionex EGC-KOH Cartridge

Temperature: See Chromatogram

Flow Rate: 1 mL/min

Inj. Volume: 10 µL

Detection: Integrated Amperometry, quadruple pulse waveform

Working Electrode: PTFE Gold, disposable electrode

Reference Electrode: Ag/AgCl

Diluted Standard: (50 nmol/mL / DI Water)

Figure 14 Effect on Temperature on the Monosaccharide Selectivity Using CarboPac PA10 4 mm column

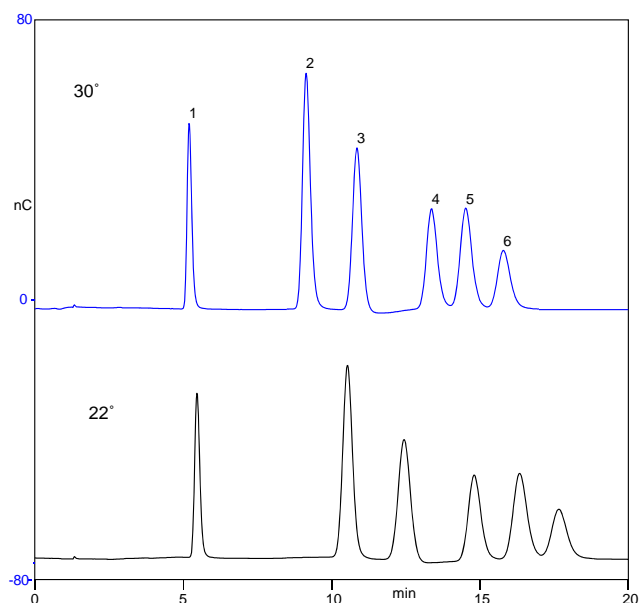

Eluent Program

Time	KOH Concentration (mM)	Comments
-35	100	Cleaning
-20	100	
-19.9	18	Equilibration
0	18	Load/inject
20	18	

Peaks

1. Fucose
2. Galactosamine
3. Glucosamine
4. Galactose
5. Glucose
6. Mannose

6.7 Effect of Temperature on the Separation of Monosaccharides Using Dionex CarboPac PA10 (0.4 × 250 mm) and EGC:

The Dionex CarboPac PA10 is capable of withstanding wide range of temperatures. However, temperature does affect the column selectivity. The following chromatogram shows the separation of six monosaccharides at 22°C and at 30°C using EGC generated eluent and CarboPac PA10 0.4 mm. Note that 30°C is an optimum temperature for the separation of Galactose, Glucose and Mannose.

Figure 15 Effect on Temperature on the Monosaccharide Selectivity Using CarboPac PA10 0.4 mm Column

Column: Dionex CarboPac PA10 (0.4 × 50 mm)
Dionex CarboPac PA10 (0.4 × 250 mm)

Eluent: Cleaning Eluent – 100 mM KOH
Elution Eluent – 18 mM KOH

Eluent Source: Dionex EGC-KOH (Capillary) Cartridge

Temperature: See Chromatogram

Flow Rate: 10 µL/min

Inj. Volume: 0.4µL

Detection: Integrated Amperometry, quadruple pulse waveform

Working Electrode: PTFE Gold, disposable electrode

Reference Electrode: Ag/AgCl

Diluted Standard: (12.5 nmol/mL / DI Water)

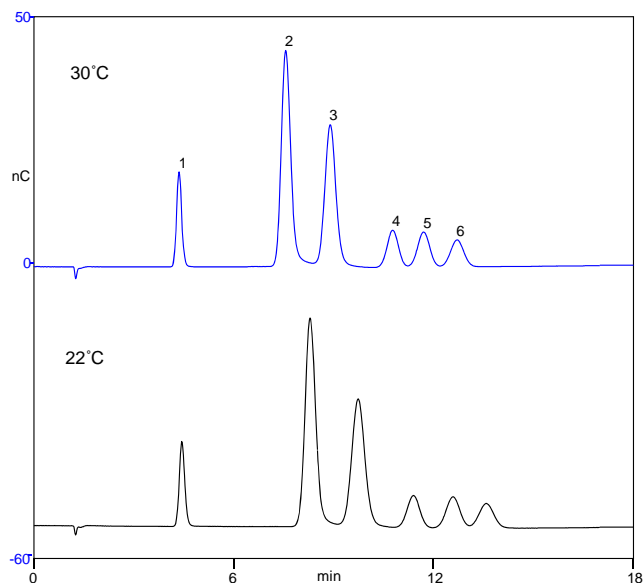

Eluent Program

Time	KOH Concentration (mM)	Comments
-40	100	Cleaning
-25	100	
-24.9	18	Equilibration
0	18	Load/inject
20	18	

Peaks

1. Fucose
2. Galactosamine
3. Glucosamine
4. Galactose
5. Glucose
6. Mannose

6.8 Comparison of Silver/Silver chloride and PdH Reference Electrodes Using CarboPac PA10 (0.4 × 250 mm) column

As demonstrated in the chromatogram below, Dionex CarboPac PA10 0.4 mm capillary column can also be used with a PdH reference electrode for the monosaccharide composition analysis. Note that the PdH reference electrode is more suitable for long term use than silver/silver chloride, however, waveform potentials for each reference electrode are different as listed below.

Column:	Dionex CarboPac PA10 (0.4 × 50 mm) Dionex CarboPac PA10 (0.4 × 250 mm)
Eluent:	Cleaning Eluent – 100 mM KOH Elution Eluent – 18 mM KOH
Eluent Source:	Dionex EGC-KOH (Capillary) Cartridge
Temperature:	30°C
Flow Rate:	10 µL/min
Inj. Volume:	0.4µL
Detection:	Integrated Amperometry, quadruple pulse waveform
Working Electrode:	PTFE Gold, disposable electrode
Reference Electrode:	See Chromatogram
Diluted Standard:	(12.5 nmol/mL / DI Water)

WaveformName = "Carbohydrates (Standard Quad)"					
Electrode = AgCl			Electrode = PdH		
Time	Potential	Integration	Time	Potential	Integration
0	0.10		0	0.95	
0.2	0.10	Begin	0.2	0.95	Begin
0.4	0.10	End	0.4	0.95	End
0.41	-2.00		0.41	-1.15	
0.42	-2.00		0.42	-1.15	
0.43	0.60		0.43	1.45	
0.44	-0.10		0.44	0.75	
0.5	-0.10		0.5	0.75	

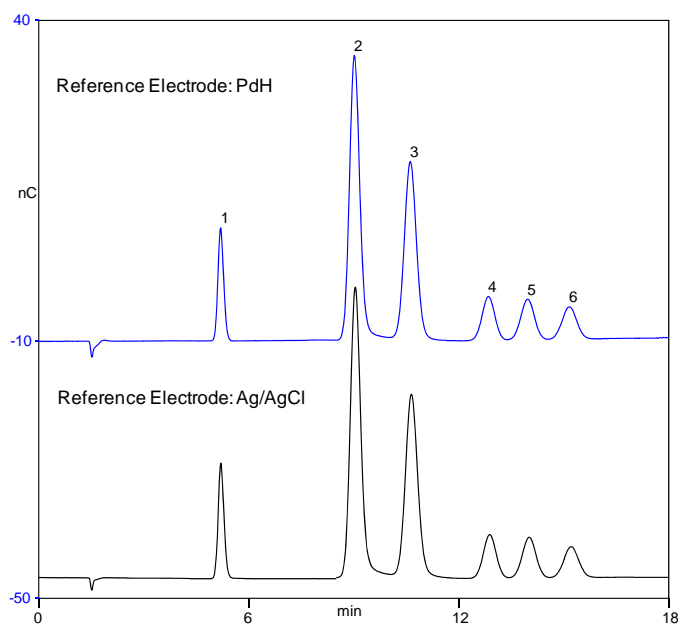

Eluent Program

Time	KOH Concentration (mM)	Comments
-40	100	Strong Wash
-25	100	
-24.9	18	Equilibration
0	18	Load/Inject
20	18	

Peaks

1. Fucose
2. Galactosamine
3. Glucosamine
4. Galactose
5. Glucose
6. Mannose

6.9 Monosaccharide Composition Analysis of Fetuin Hydrolysate Using Dionex CarboPac PA10 (4 × 250 mm):

Many mammalian proteins have carbohydrates attached to them. In many cases, the presence of a carbohydrate controls biological activity of a protein or the rate at which a protein is cleared from a biological system. The protein glycosylation is important to many scientists especially to those preparing recombinant proteins for the therapeutic use. As demonstrated in the chromatogram below, Dionex CarboPac PA10 4 mm provides an optimal resolution for monosaccharide composition analysis.

Figure 16 Monosaccharide Analysis of Fetuin Hydrolysate Sample Using CarboPac PA10 Analytical Column

Column:	Dionex CarboPac PA10 (4 × 50 mm) Dionex CarboPac PA10 (4 × 250 mm)
Eluent:	Cleaning Eluent – 100 mM KOH Elution Eluent – 18 mM KOH
Eluent Source:	Dionex EGC-KOH Cartridge
Temperature:	30°C
Flow Rate:	1.0 mL/min
Inj. Volume:	10 µL
Detection:	Integrated Amperometry, quadruple pulse waveform
Working Electrode:	PTFE Gold, disposable electrode
Reference Electrode:	Ag/AgCl
Sample:	0.4 nmol/mL Fetuin Hydrolysate (with DI water)
Standard:	50 nmol/mL each (with DI water)

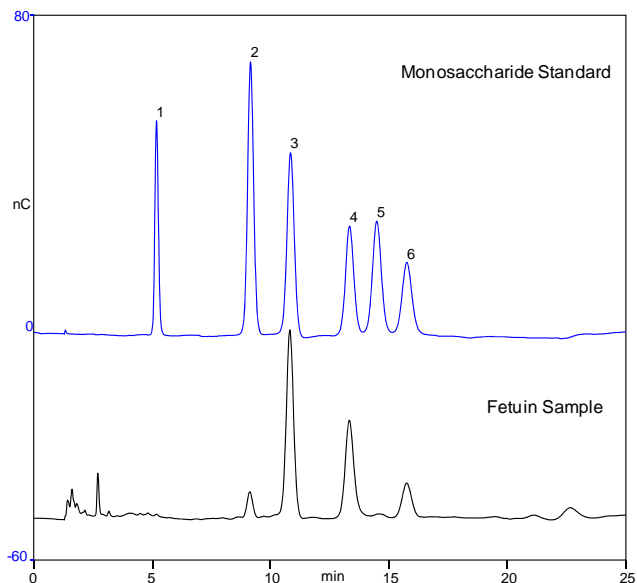

Eluent Program

Time	KOH Concentration (mM)	Comments
-40	100	Strong Wash
-20	100	
-19.9	18	Equilibration
0	18	Load/Inject
30	18	

Peaks (Standard)

1. Fucose
2. Galactosamine
3. Glucosamine
4. Galactose
5. Glucose
6. Mannose

6.10 Monosaccharide Composition Analysis of Fetuin Hydrolysate Using Dionex CarboPac PA10 (0.4 × 250 mm):

As demonstrated in the chromatogram below, Dionex CarboPac PA10 0.4 mm capillary column can also be used for the monosaccharide composition analysis. Note that the same sample concentration as in [Figure 16](#) can be injected onto the capillary column. However, if sample concentration is high and linearity is compromised, then the sample must be diluted.

Figure 17 Monosaccharide Analysis of Fetuin Hydrolysate Sample Using CarboPac PA10 Capillary Column

Column:	Dionex CarboPac PA10 (0.4 × 50 mm) Dionex CarboPac PA10 (0.4 × 250 mm)
Eluent:	Cleaning Eluent – 100 mM KOH Elution Eluent – 18 mM KOH
Eluent Source:	Dionex EGC-KOH (Capillary) Cartridge
Temperature:	30°C
Flow Rate:	10 µL/min
Inj. Volume:	0.4 µL
Detection:	Integrated Amperometry, quadruple pulse waveform
Working Electrode:	PTFE Gold, disposable electrode
Reference Electrode:	Ag/AgCl
Sample:	0.4 nmol/mL Fetuin Hydrolysate (with DI water)
Standard:	50 nmol/mL each (with DI water)

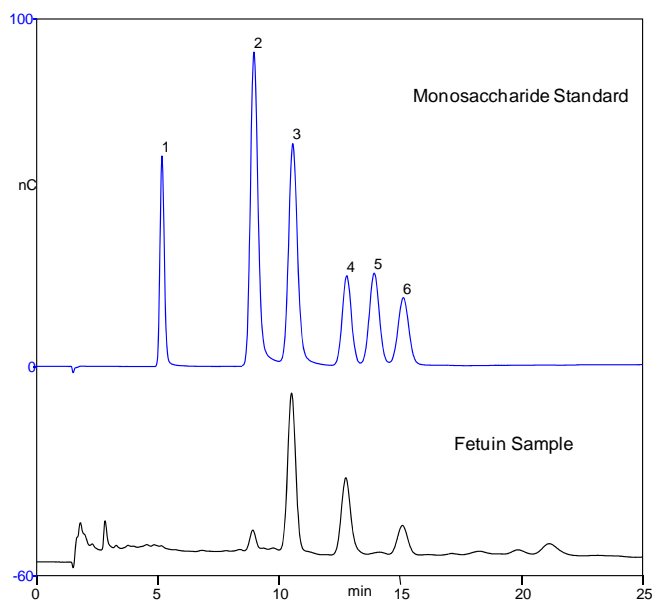

Eluent Program

Time	KOH Concentration (mM)	Comments
-45	100	Strong Wash
-25	100	
-24.9	18	Equilibration
0	18	Load/Inject
30	18	

Peaks (Standard)

1. Fucose
2. Galactosamine
3. Glucosamine
4. Galactose
5. Glucose
6. Mannose

6.11 Effect of AminoTrap Column on Monosaccharide Composition Analysis of Fetuin Hydrolysate Using AminoTrap Column Coupled with Dionex CarboPac PA10 (4 × 250 mm):

The Dionex AminoTrap, placed before the Dionex CarboPac PA10, improves quantitation of monosaccharides in matrices containing amino acids. Specifically designed to retain amino acids with minimal retention of carbohydrates, the Dionex AminoTrap allows monosaccharides to elute well before interfering amino acids.

AminoTrap is specifically designed with high selectivity for amino acids, the AminoTrap delays the amino acids, thus allowing the monosaccharides to be separated without interference from amino acids. Note that minor interferences caused by the amino acids from the fetuin sample can be removed by using AminoTrap column as shown in the chromatogram below

Figure 18 Monosaccharide Analysis of Fetuin Hydrolysate Sample Using CarboPac PA10 Analytical Column and Amino Trap Column

Column:	Dionex CarboPac PA10 (4 × 50 mm) or AminoPac (4 × 50 mm) Dionex CarboPac PA10 (4 × 250 mm)
Eluent:	Cleaning Eluent – 100 mM KOH Elution Eluent – 18 mM KOH
Eluent Source:	Dionex EGC-KOH Cartridge
Temperature:	30°C
Flow Rate:	1mL/min
Inj. Volume:	10µL
Detection:	Integrated Amperometry, quadruple pulse waveform
Working Electrode:	PTFE Gold, disposable electrode
Reference Electrode:	Ag/AgCl
Sample:	0.4 nmol/mL Fetuin Hydrolysate
Standard:	50 nmol/mL each (with DI water)

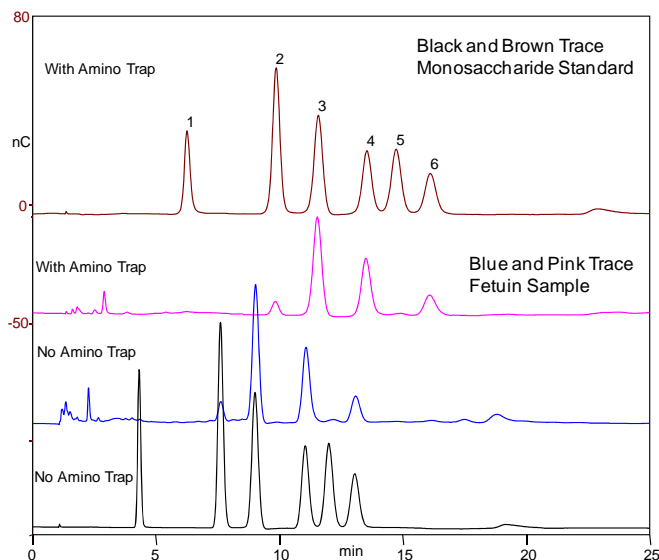

Eluent Program

Time	KOH Concentration (mM)	Comments
-40	100	Strong Wash
-20	100	
-19.9	18	Equilibration
0	18	Load/Inject
30	18	

Peaks

1. Fucose
2. Galactosamine
3. Glucosamine
4. Galactose
5. Glucose
6. Mannose

6.12 Effect of BorateTrap on the Peak Shape of Monosaccharides Using Dionex CarboPac PA10 (2 × 250 mm):

Borate can affect symmetry of monosaccharide peaks, even when present in the low part-per-billion concentration range. Borate is one of the first ions to break through in water deionization system. Its presence in the water that is used to make up eluents for carbohydrate analysis can cause a significant loss of peak efficiency, especially for mannose. The BorateTrap (P/N 047078) is used immediately before the injection valve and serves to remove borate from the eluent. A Borate Trap is not needed for systems with an eluent generator and CR-ATC (for more details, see Dionex Technical Note 40) or when plastic bottles are used to prepare eluents.

To demonstrate the benefit of a Borate Trap, eluents were prepared in glass bottles and then data was collected after three days with and without Borate Trap. Note that D-mannose sensitivity and peak shape is affected by the presence of borate in the eluent as shown in the top trace.

Figure 19 Dionex CarboPac PA10 (2 × 250 mm) Separation of QAR Standard – Borate Trap

Column: Dionex BorateTrap (4 × 50 mm)
Dionex CarboPac PA10 (2 × 50 mm)
Dionex CarboPac PA10 (2 × 250 mm)

Eluent: A – 200 mM NaOH
B – 18 mM NaOH

Temperature: 30°C

Flow Rate: 0.25mL/min

Inj. Volume: 2.5µL

Detection: Integrated Amperometry, quadruple pulse waveform

Working Electrode: PTFE Gold, disposable electrode

Reference Electrode: Ag/AgCl

Diluted Standard: (50.0 nmol/mL / DI Water)

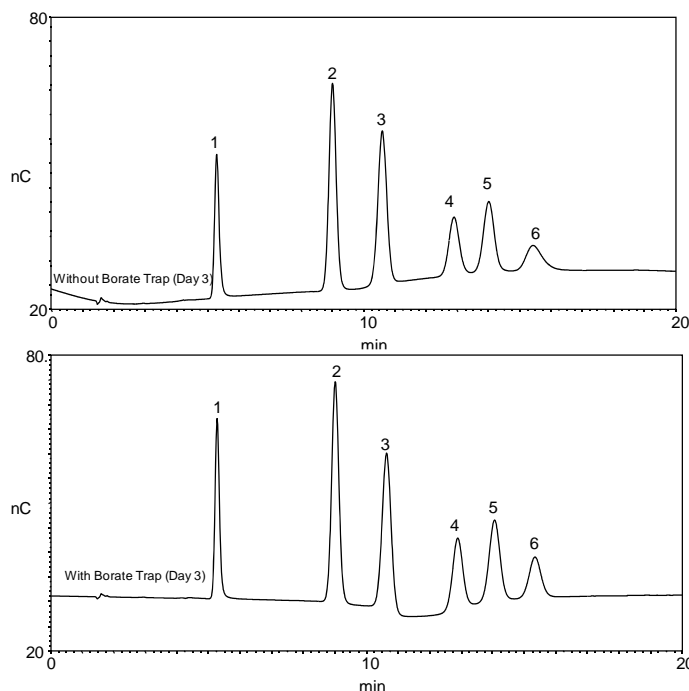

Eluent Program

Time	%A	%B	Comments
-30	100	0	Cleaning
-15	100	0	
-14.9	0	100	Equilibration
0	0	100	Load/inject
20	0	100	

Peaks

1. Fucose
2. Galactosamine
3. Glucosamine
4. Galactose
5. Glucose
6. Mannose

7. Troubleshooting Guide

Remember that some of the problems may be related to parts of your experimental protocol (sample contamination, imprecision during sample transfer, problems during peptide or protein hydrolysis, etc.). The following text should help you to locate and eliminate problems traceable to the carbohydrate hardware and chemistries. It also provides a selection of cleanup and reconditioning procedures that have been found effective by many users.

7.1 High Background

While it may be possible to obtain reasonable performance even with elevated levels of detection background according to some requirements, high background frequently brings about an increased size of gradient artifacts and can be accompanied by a presence of ghost peaks. Detection sensitivity may also change suddenly when the detection background is too high.

A background >30 nC with 10 mM sodium hydroxide at 0.5 mL/min and 30°C using the quadruple waveform indicates one of the following possibilities:

- A. Incorrect detection parameters.
Verify that Ag/AgCl is specified as a reference electrode. Check all values of waveform in program against those in the Disposable Electrode Manual. If the pH reading with 10 mM NaOH or KOH is above 13.2 replace the reference electrode.
- B. Compromised working electrode surface.
Briefly install a new working electrode and check the background as above. If the reading remains > 30 nC, remove the new electrode within 30 minutes and continue testing for column or system contamination. Otherwise continue with your work with the new electrode installed.
- C. Column contamination.
Remove the column set from the system first and replace it with a length of yellow PEEK tubing, generating a pressure drop between 1000 and 2000 psi. If the background reading improves after the column is removed from the system, go to [Section 7.3](#).
- D. Water contamination.
Prepare eluents using a fresh ultra pure water from another source. If the background is reduced, investigate the source of contamination in the original source of water.
- E. System contamination.
If the background remains high even with fresh water and without the column, carry out the 2 M sodium hydroxide rinse described in [Section 7.5](#).

7.2 Decreased Detection Sensitivity

Always confirm the loss of response by performing at least one injection of the system suitability standard mix as described in [Section 6.1](#) or [6.2](#). This is to make sure that a decreased level of response is not being caused by system problems.

Any decrease in detection sensitivity means that the working electrode surface has been affected. The operator should install a new working electrode. Spare gold working electrodes should always be available in order to avoid unnecessary delays.

Exception:

Check the pH reading. If the value is out of range or >13.2, install a new reference electrode and then install a new gold working electrode. The system cleanup is not necessary. The decrease in sensitivity was caused by a gold-oxide-buildup on the electrode surface because the reference potential was too high. The non-disposable gold working electrode can be reconditioned by polishing.

After installing a new working electrode (with or without the complete system cleanup), confirm the normal detection sensitivity. Carry out a test with a reference standard. Should the response be too low, immediately remove the new working electrode from the system.

7.3 Column Problems

The guard column protects the main column not only from contamination but also from excessive pressure fluctuations caused by the instrument or by operator errors. Have the guard column installed at all times, disconnect it only during some of the testing described in this section, or when priming the pump to prevent accidental over pressure.

The column set is causing the high background if the background reading decreases after the column is replaced by a section of PEEK tubing, as described in [Section 5.5.1](#).

7.3.1 Excessive Gradient Rise

The magnitude of the gradient rise can be minimized by running high eluent strengths during the times when the system is not in use for sample or standard analysis. This will keep the column conditioned, free from carbonate buildup, and ready for analysis.

- A. Make sure the gradient rise is not caused by the system and/or detector cell.
- B. Increase column temperature to 40 °C and wash the guard and column with 200mM NaOH or KOH for at least four hours (preferably overnight). Run a blank gradient at 30 °C and if necessary repeat the clean up with 100 mM NaOH, 950 mM sodium acetate wash at 40 °C.

7.3.2 Peak Efficiency and Resolution are Decreasing

Always have a spare Guard available. Peak deformations may sometimes be caused by sample matrix.

- A. Run a standard separation with the Guard column removed from the system. Install a new Guard column should the separation improve with the old Guard removed. It is common to replace Guard columns several times during the lifetime of an analytical column.
- B. Verify that correct tubing is installed for all connections between injector and detector, see [Section 2.1.3](#).
- C. Check for proper installation of ferrules on all PEEK tubing starting with the injector outlet and all other connectors to the ED cell inlet.
- D. Check temperature settings in your method and/or actual temperature in your column oven.
- E. The column may be overloaded. Try to inject a smaller amount of your sample or dilute the sample more.
- F. If all of the above does not lead to an improved separation, the resin bed of the main column has been damaged and the main column must be replaced.

7.4 System Problems

7.4.1 High Detection Background Caused by the System

- A. Verify the problem is neither the detector nor column related.
- B. Prepare new eluents.
- C. Rinse all three eluent lines with the new eluents.

7.4.2 No Peaks, Poor Peak Area Reproducibility or too Small Peak Areas

- A. Check the position and filling levels of sample vials in the autosampler.
- B. Check injector needle-height setting.
- C. Check each line of the schedule for proper injector parameters. Revert to full loop and column appropriate sample loop size.
- D. Service the injection valve (check for leaks, Tefzel fragments, or sediments inside the valve).

7.4.3 Large Baseline Dip in the Chromatogram

A large baseline dip appearing between 17 and 19 minutes when the guard column is installed is usually caused by oxygen in the sample injected. The 'oxygen dip' is normal and can be reduced in magnitude with higher NaOH concentration in the eluent.

7.4.4 Incorrect or Variable Retention Times

- A. Check your eluent preparation procedure for possible errors.
- B. Prime the pump if necessary. Set the eluent composition for 100% for each eluent and draw out at least 40 mL of eluent from each of the lines.
- C. Wash the column with 200mM KOH or NaOH for two hours or longer to eliminate the excessive carbonate contamination of the column when ran with 18mM KOH or NaOH for extended period of time.
- D. Verify if the equilibration time after the strong wash is optimum by increasing the equilibration time.
- E. Measure the flow rate by weighing out the eluent collected during exactly five minutes of flow. Recalibrate the pump if necessary.
- F. Samples containing high salt content (> 50 mM) will decrease the retention times.
- G. Check and/or service the pump's proportioning valve. With the pumping turned off, the flow through the pump outlet tubing (disconnected from the injector) should be zero in all eluent positions. Check this separately for each eluent line at 100% setting.

7.4.5 Unidentified Peaks Appear with Expected Analyte Peaks

During the acetate or hydroxide gradient, a number of small peaks may appear. These peaks are usually due to trace contaminants in the water supply. The contaminants accumulate on the column during the isocratic section of the chromatogram and are released, frequently as irregular baseline deformations or sharp spikes, with the increasing eluent strength.

Some trace contaminants can co-elute with monosaccharides, compromising accuracy of quantitation at lower concentrations. If extraneous peaks are observed even after the water supply is excluded as a possible cause, clean the autosampler lines and sample loop. The autosampler should be cleaned using the following protocol:

- A. Disconnect the column and detector cell from the autosampler.
- B. Set the pump to 100% deionized water.
- C. Place the following solutions in the autosampler and inject in sequence. Use 25 μ L full loop injections:
 1. 1 M NaOH
 2. Deionized water
 3. IPA
 4. Deionized water
 5. 1 M HCl
 6. Deionized water

7.5 Sodium Hydroxide Cleanup

The sodium hydroxide (200mM NaOH or KOH) rinse used to decrease column or system-related elevated background is essentially identical with the rinse performed during an installation of a new system. Following the rinse, check the background again while pumping the 10 mM sodium hydroxide and repeat the rinse at least once more if necessary. Leave the old gold working electrode in place during the first and second checking of the detection background. Use a new or reconditioned electrode only if the background remains high even after the second rinse. Should the new electrode also produce a reading of > 30 nC, remove it from the system within 30 minutes, rinse it with water and reinstall the old electrode.

7.6 Reconditioning or Replacement of the Gold (conventional or disposable) Electrodes or Replacement of the Reference Electrode

Refer to Product Manual for Disposable Electrodes Doc. No. 065040, ICS-5000 Ion Chromatography System Manual Doc. No. 065342 and User's Compendium for Electrochemical Detection Doc. No. 065340 for any help necessary with electrochemical detection, working and reference electrodes.